

# 2023



**AMERICAN OUTDOOR BRANDS™**  
SHOOTING ACCESSORIES WHOLESALE CATALOG

# TABLE OF CONTENTS

---



|   |    |
|---|----|
| <b>CALDWELL</b> ® NEW PRODUCTS_____       | 3  |
| <b>CALDWELL</b> ® RETURNING PRODUCTS_____ | 11 |



|  |    |
|--|----|
| <b>FRANKFORD ARSENAL</b> ® NEW PRODUCTS_____       | 47 |
| <b>FRANKFORD ARSENAL</b> ® RETURNING PRODUCTS_____ | 54 |



|   |    |
|---|----|
| <b>TIPTON</b> ™ RETURNING PRODUCTS_____ | 73 |
|---|----|



|  |    |
|--|----|
| <b>WHEELER</b> ™ NEW PRODUCTS_____       | 89 |
| <b>WHEELER</b> ™ RETURNING PRODUCTS_____ | 94 |



|   |     |
|---|-----|
| <b>LOCKDOWN</b> ® NEW PRODUCTS_____       | 119 |
| <b>LOCKDOWN</b> ® RETURNING PRODUCTS_____ | 125 |



|                                      |     |
|--------------------------------------|-----|
| <b>BOG</b> ® NEW PRODUCTS_____       | 139 |
| <b>BOG</b> ® RETURNING PRODUCTS_____ | 146 |



|   |     |
|---|-----|
| <b>SMITH &amp; WESSON</b> ® RETURNING PRODUCTS_____ | 165 |
|---|-----|



|   |     |
|---|-----|
| <b>M&amp;P</b> ® BY <b>SMITH &amp; WESSON</b> ® RETURNING PRODUCTS_____ | 174 |
|---|-----|



 **CALDWELL®**

**2023 NEW PRODUCTS**

# CLAYMORE™ CLAY TARGET THROWER

PRODUCT# 1122187 • UPC# 661120081425

- + FOOT PEDAL POWERED, NO BATTERY REQUIRED TO OPERATE
- + 50 CLAY CAPACITY - MORE TIME SHOOTING, LESS TIME LOADING CLAYS
- + COMPACT FOLDING DESIGN FOR EASY TRANSPORTATION & STORAGE
- + SELECTABLE FLURRY MODE LAUNCHES CLAYS AS FAST AS YOU CAN STEP ON THE PEDAL

The Caldwell Claymore provides all the benefits of an electric clay thrower without having to tote a heavy battery around. This easy to cock, foot-operated manual device can throw clays 55-70 yards and can hold 50 clays in the target magazine. It features a standard mode and a flurry mode which allows for a continuous step-and-throw sequence that launches clays as fast as you can step on the pedal. To expand on the versatility of the Caldwell Claymore, it also features adjustable launch angles to provide multiple shot options for the shooter. The Claymore weighs only 35 lbs and is collapsible for easy storage and transport. Get out and shatter some clays either by yourself or with some friends with the Caldwell Claymore!



patents: aob.com/patents

# E-MAX® PRO BT COMMS

PRODUCT# 1136235 • UPC# 661120259978

- + INTEGRATED RADIO ALLOWS FOR HANDS FREE COMMUNICATION WHILE STILL PROVIDING 23dB NRR HEARING PROTECTION
- + LONG AND SHORT AMBIDEXTROUS MICROPHONE OPTIONS PREVENT CLEARANCE ISSUES WITH STOCKS
- + ALLOWS FOR CLEAR COMMUNICATION BETWEEN USERS OVER EXTENDED DISTANCE
- + BLUETOOTH® CONNECTIVITY FOR STREAMING MUSIC AND TAKING CALLS
- + 22 CHANNEL SETTINGS FOR MULTIPLE PARTIES WITHIN THE SAME AREA

The E-MAX Pro BT Comms combine Caldwell's unmatched hearing protection with Bluetooth communication ability via a high-quality ambidextrous boom microphone. Coming in at 23dB NRR and having an over 200 yard communication range, chat with multiple users on the range, listen to music, and protect your hearing simultaneously with the E-MAX Comms. Featuring an improved headband system to provide added comfort when wearing a hat - the headband is also removable to make the muffs helmet mount compatible.



"The Bluetooth® word mark and logos are registered trademarks owned by Bluetooth SIG, Inc. and any use of such marks by AOB Products Company is under license. Other trademarks and trade names are those of their respective owners."

patents: aob.com/patents

# E-MAX® LINK

PRODUCT# 1142645 • UPC# 661120260004

- + PAIRS WITH CALDWELL BLUETOOTH® HEARING PROTECTION FOR WIRELESS COMMUNICATION
- + AUDIO PORT FOR CONNECTING TO ALL NON-BLUETOOTH CALDWELL E-MAX EARMUFFS
- + 12-MILE RANGE ALLOWS FOR LONG DISTANCE COMMUNICATION
- + 22 CHANNEL SETTINGS FOR MULTIPLE PARTIES WITHIN THE SAME RANGE

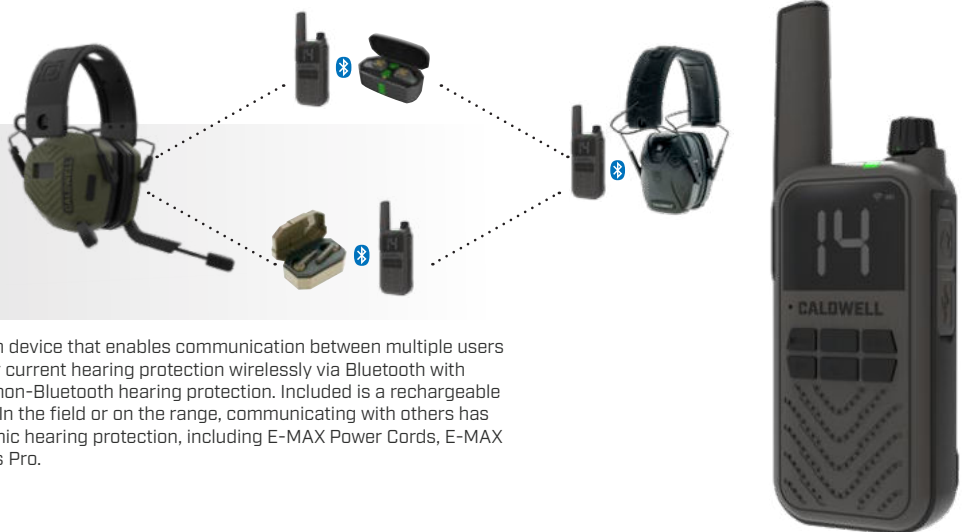

The E-MAX Link is an advanced Bluetooth communication device that enables communication between multiple users up to 12 miles (line of sight). The E-MAX Link pairs to your current hearing protection wirelessly via Bluetooth with compatible muffs, plugs, or with a 3.5mm audio cord for non-Bluetooth hearing protection. Included is a rechargeable battery (optional 3xAAA use), with a USB-C charging cord. In the field or on the range, communicating with others has never been easier! Use the Link with any Caldwell electronic hearing protection, including E-MAX Power Cords, E-MAX Pro, E-MAX Pro BT, E-MAX Shadows and E-MAX Shadows Pro.



"The Bluetooth® word mark and logos are registered trademarks owned by Bluetooth SIG, Inc. and any use of such marks by AOB Products Company is under license. Other trademarks and trade names are those of their respective owners."

# AR500 GAME SERIES

- + HEAVY-DUTY 3/8" AR500 STEEL RATED FOR CENTERFIRE RIFLE USE
- + SELECTION OF POPULAR GAME ANIMAL SILHOUETTES ADD VARIETY AND UNIQUE TARGET SHAPES
- + YELLOW POWDER COAT FINISH FOR HIGH VISIBILITY DOWNRANGE
- + PEACE OF MIND WITH A LIFETIME GUARANTEE ON ALL AR500 TARGETS

Caldwell's Game Series AR500 Steel Targets come in 4 different popular game silhouettes for competition, practice, and recreational use. Constructed using 3/8" AR500, the finest rifle rated target steel available on the market, capable of withstanding thousands of rounds. 1/2" x 1" center slot is compatible with the Caldwell AR500 Target Post. These targets are rated up to 3,000 fps impact velocity, 3,500 ft-lb impact energy and are covered by a lifetime guarantee.

## AR500 COMOTE TARGET

PRODUCT# 4001073 • UPC# 661120747437

## AR500 33% DEER TARGET

PRODUCT# 4001096 • UPC# 661120747420

## AR500 CROW TARGET

PRODUCT# 4001093 • UPC# 661120747444

## AR500 PRAIRIE DOG TARGET

PRODUCT# 4001099 • UPC# 661120747468



# AR500 TARGET POST

PRODUCT# 4001137 • UPC# 661120747475

- + AR500 CONSTRUCTION CAN WITHSTAND IMPACTS FROM CENTERFIRE RIFLES
- + SPIKE-LEG DESIGN CREATES FOR QUICK AND EASY SET UP
- + 2 PIECE DESIGN FOR TRANSPORTATION AND STORAGE

The Caldwell AR500 Target Post is the strongest target hanger on the market. Constructed using the same 3/8" AR500 rifle rated steel as our targets, capable of withstanding thousands of rounds. Compact 2-piece design for easy transportation with a replaceable AR500 hook that works with all targets with a 1/2" x 1" slot. Assembled length of 70" supports targets up to 50 lbs.

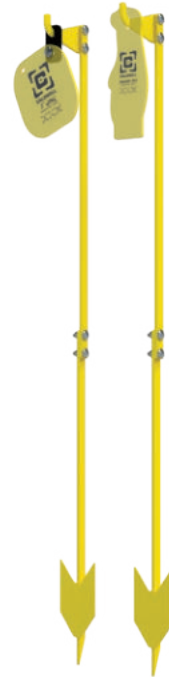

# AR500 DUAL SPINNER TARGET

PRODUCT# 1196226 • UPC# 661120747451

- + HEAVY-DUTY 3/8" AR500 STEEL RATED FOR CENTERFIRE RIFLE USE
- + SPINNING TARGET DESIGN IS FUN AND CHALLENGING
- + 5" AND 8" PLATES ARE THE PERFECT SIZE FOR BOTH RIFLE AND HANDGUN USE
- + COLLAPSIBLE STAND MAKES FOR EASY SETUP, TAKEDOWN AND STORAGE
- + PEACE OF MIND WITH A LIFETIME GUARANTEE ON AR500 TARGETS

The Caldwell AR500 Dual Spinner Target includes everything you need for a great day at the range. Featuring dual 5" and 8" AR500 steel targets that are capable of withstanding thousands of rounds and a collapsible steel stand for easy transport. The dual spinning targets offer a fun and challenging target for competition, plinking, or training. Perfect for centerfire rifles and handguns, these targets are rated up to 3,000 fps impact velocity and 3,500 ft-lb impact energy.



# AR500 SWINGING TARGET

PRODUCT# 1187590 • UPC# 661120652625

- + 3/8" AR500 CONSTRUCTION CAN WITHSTAND IMPACTS FROM CENTERFIRE RIFLES
- + EXTREMELY DURABLE CAST URETHANE FRAME CONNECTORS PROVIDE A RIGID FRAME YET ALLOWS BULLETS TO PASS RIGHT THROUGH
- + SOLID STEEL LEGS AND CROSSBAR PROVIDE A RIGID FRAME BUT CAN BE REPLACED BY 1/2" REBAR IF DAMAGED
- + PEACE OF MIND WITH A LIFETIME GUARANTEE ON AR500 TARGET

The Caldwell AR500 Swinging Target is constructed using 3/8" rifle rated AR500 steel. The extremely durable cast urethane frame connectors provide a rigid frame yet allows bullets to pass through without damage. The solid steel legs and crossbar provide a rigid frame that can be replaced by 1/2" rebar if damaged. The target frame is 18" off the ground and 10" to the center of the target. The AR500 Swinging Target is highly portable for ease of use. 4 ground stakes are included to secure the target for large rifle impacts. Perfect for centerfire rifles and handguns, these targets are rated up to 3,000 fps impact velocity and 3,500 ft-lb impact energy.



# ULTIMATE STEEL TARGET STAND

PRODUCT# 4001148 • UPC# 661120747536

- + DUAL PURPOSE DESIGN HOLDS 1X2 OR 2X4 FOR BOTH STEEL AND PAPER TARGET USE
- + ANGLED 2X4 HOLDS UP TO FULL-SIZE IPSC TARGET WITHOUT FALLING OVER
- + 1X2 STAKE POCKETS FOR COMMON PAPER/CARDBOARD TARGETS

Ultimate Steel Target Stand can be used to set both steel and paper targets on almost any range. The H-stand design allows flexibility in target setup without driving posts or stakes into the ground. The angled center 2x4 pocket can be combined with the Caldwell 2x4 Plate Hanger (sold separately) to hang any Caldwell AR500 steel, including full size IPSC targets on any 2x4 post. The 1x2 stake pockets are perfect for setting up paper or cardboard targets at any distance. Comes with 2 ground stakes.



\*Target Not Included

# SHEPHERD'S HOOK STEEL TARGET HANGER

PRODUCT# 3002281 • UPC# 661120652175

- + QUICK & EASY LIGHTWEIGHT DESIGN FOR CONVENIENT TARGET HANGING
- + DURABLE STEEL FRAME HOLDS UP TO A 16 LB STEEL TARGET
- + INCLUDED NYLON REINFORCED RUBBER STRAP REDUCES FATIGUE ON STEEL FRAME

Caldwell's Shepherd's Hook Target Hangers are a quick and easy target hanging solution for any range. A nylon reinforced rubber strap means these hangers won't fatigue with extended shooting like traditional wire shepherd's hooks. This extremely durable stand comes in at 45" tall and can hold up to a 16 lb steel target (equivalent to our 13" AR500 Octagon target). Upgrade your range with a Caldwell Shepherd's Hook!



\*Target Not Included

# FLASH BANG TARGET HIT INDICATOR

PRODUCT# 1198772 · UPC# 661120747529

- + 10 FLASHING LED LIGHTS NOTIFY SHOOTER OF AN IMPACT AT EXTENDED RANGES
- + LOW IMPACT ENERGY DETECTION EASILY DETECTS .223 HITS AT 1,000 YARDS
- + VERSATILE, COMPACT DESIGN WORKS ON MOST STEEL TARGETS OVER 5"

The Caldwell Flash Bang Target Hit Indicator brings new feedback to shooters when using steel targets. Flashing green LED lights are triggered by an impact on the target telling shooters of their hits at extremely long ranges where confirmed hits can be difficult. The self-contained unit features 10 ultra-bright green LED lights that are visible for thousands of yards, even in bright daylight conditions. Powered by 3 "AA" batteries (included), the Flash Bang has a battery life of over 5,000 impacts. The Flash Bang is compatible with targets over 5" and attaches easily with heavy-duty hook and loop material.



[66% IPSC TARGET]



# E-MAX<sup>®</sup> PRO BT LITHIUM

PRODUCT# 1181236 · UPC# 661120999553

- + LAB CERTIFIED 24dB NRR HEARING PROTECTION
- + BLUETOOTH<sup>®</sup> CONNECTIVITY FOR STREAMING MUSIC
- + LOW PROFILE EAR CUPS FOR RIFLE & SHOTGUN STOCK CLEARANCE
- + DUAL MICROPHONES FOR 360° DIRECTIONAL CLARITY

The E-MAX Pro BT Lithium features high quality Bluetooth hearing protection with an all-day comfortable fit all at an affordable price. These E-MAX are Bluetooth compatible with mobile devices and have a 24dB NRR. With high quality stereo sound and easy to use push button volume controls, you can listen to all your favorite music while on the range. Runs on an included rechargeable lithium-ion battery.



"The Bluetooth" word mark and logos are registered trademarks owned by Bluetooth SIG, Inc. and any use of such marks by AOB Products Company is under license. Other trademarks and trade names are those of their respective owners."

# E-MAX<sup>®</sup> LITHIUM-ION BATTERY

PRODUCT# 1181238 · UPC# 661120264972

- + COMPATIBLE WITH E-MAX PRO & E-MAX PRO BT EARMUFFS
- + ESTIMATED 16 HOURS RUNTIME FOR EXTENDED USE

The E-MAX Lithium-Ion Battery is compatible with Caldwell E-MAX Pro hearing protection. Simply charge the battery pack with a micro USB cable and the LED charge indicator will show when the battery is fully charged. With a 16 hour runtime, this rechargeable battery pack securely fits in your electronic hearing protection to keep your E-MAX Pros running for a day at the range.



# ORANGE PEEL® TARGETS

- + DUAL COLOR FLAKE-OFF DESIGN MAKES FOR EASY SHOT DETECTION
- + ADHESIVE BACKED - NO STAPLES OR CLIPS REQUIRED
- + MULTIPLE SIZES & DESIGNS PROVIDE THE PERFECT TARGET FOR ANY SITUATION
- + EXTENDED TARGET LIFE WITH INCLUDED REPAIR PASTERS

Caldwell Orange Peel Targets let you see hits on the target with dual color flake-off technology that makes your hits look like colorful explosions. If your shot happens to miss the bullseye, you will know exactly where your bullet strayed instantly. The high contrast orange background and black target make acquisition through the scope easy, even at long distances. No need for staples or push pins, these targets feature an adhesive back that sticks to almost any surface. Pastes are included in each pack to repair the targets for even more use.

- 5.5" BULLSEYE TARGET - 10PK**  
PRODUCT# 1166107 - UPC# 661120652045
- 5.5" BULLSEYE TARGET - 25PK**  
PRODUCT# 1166108 - UPC# 661120652052
- 8" BULLSEYE TARGET - 5PK**  
PRODUCT# 1166109 - UPC# 661120652076
- 8" BULLSEYE TARGET - 25PK**  
PRODUCT# 1166110 - UPC# 661120652069
- 8" SIGHT-IN TARGET - 5PK**  
PRODUCT# 1166102 - UPC# 661120652090
- 8" SIGHT-IN TARGET - 25PK**  
PRODUCT# 1166103 - UPC# 661120652083
- 12" TURKEY TARGET - 5PK**  
PRODUCT# 1175518 - UPC# 661120652188

- 12" BULLSEYE TARGET - 5PK**  
PRODUCT# 1166111 - UPC# 661120651994
- 12" BULLSEYE TARGET - 25PK**  
PRODUCT# 1166112 - UPC# 661120652199
- 12" SIGHT-IN TARGET - 5PK**  
PRODUCT# 1166104 - UPC# 661120652021
- 12" SIGHT-IN TARGET - 25PK**  
PRODUCT# 1166105 - UPC# 661120652007
- 12"X18" SILHOUETTE TARGET - 5PK**  
PRODUCT# 1175517 - UPC# 661120652151
- 16" SIGHT-IN TARGET - 5PK**  
PRODUCT# 1166106 - UPC# 661120652038



patents: aob.com/patents

# ORANGE PEEL® DISPLAYS

## COUNTERTOP DEALER KIT

PRODUCT# 1200354 • UPC# 661120747598

| Product# | Description                                      | Qty |
|----------|--|-----|
| 1196197  | COUNTERTOP ORANGE PEEL TARGET DISPLAY            | 1   |
| 1166107  | 5.5" ORANGE PEEL BULLSEYE TARGET - 10 SHEETS     | 40  |
| 1166102  | 8" ORANGE PEEL SIGHT-IN TARGET - 5 SHEETS        | 40  |
| 1166109  | 8" ORANGE PEEL BULLSEYE TARGET - 5 SHEETS        | 20  |
| 1166104  | 12" ORANGE PEEL SIGHT-IN TARGET - 5 SHEETS       | 20  |
| 1166111  | 12" ORANGE PEEL BULLSEYE TARGET - 5 SHEETS       | 20  |
| 1175522  | 12"X18" CENTER MASS SILHOUETTE TARGET - 8 SHEETS | 10  |
| 1175517  | 12"X18" ORANGE PEEL BULLSEYE TARGET - 5 SHEETS   | 10  |

## FREE-STANDING DEALER KIT

PRODUCT# 1200349 • UPC# 661120747604

| Product# | Description                                    | Qty |
|----------|--|-----|
| 1196196  | FREE STANDING ORANGE PEEL TARGET DISPLAY       | 1   |
| 1166107  | 5.5" ORANGE PEEL BULLSEYE TARGET - 10 SHEETS   | 40  |
| 1166102  | 8" ORANGE PEEL SIGHT-IN TARGET - 5 SHEETS      | 20  |
| 1166109  | 8" ORANGE PEEL BULLSEYE TARGET - 5 SHEETS      | 40  |
| 1166104  | 12" ORANGE PEEL SIGHT-IN TARGET - 5 SHEETS     | 30  |
| 1166111  | 12" ORANGE PEEL BULLSEYE TARGET - 5 SHEETS     | 30  |
| 1166106  | 16" ORANGE PEEL SIGHT-IN TARGET - 5 SHEETS     | 20  |
| 1175517  | 12"X18" ORANGE PEEL BULLSEYE TARGET - 5 SHEETS | 20  |

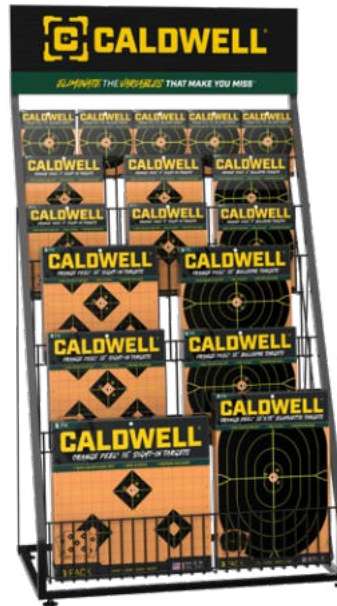

Size: 32"W x 60"H x 25"D

COUNTERTOP DISPLAY ONLY  
PRODUCT# 1196197 - UPC# 661120747505

FREE-STANDING DISPLAY ONLY  
PRODUCT# 1196196 - UPC# 661120747512

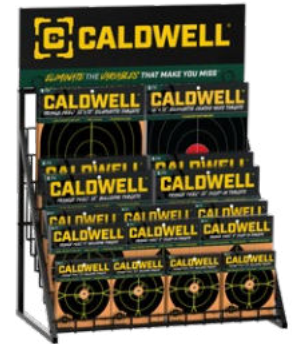

Size: 26"W x 25"H x 13"D

# SILHOUETTE DUAL ZONE TARGETS

## 8 PACK

PRODUCT# 1175523 • UPC# 661120652144

- + HI VISIBILITY FLAKE OFF TECHNOLOGY
- + IDEAL FOR DEFENSIVE SHOOTING SKILL DEVELOPMENT
- + HEAVY CARD STOCK PAPER
- + 12" X 18" TARGET SIZE

The Silhouette Dual Zone Targets are perfect for honing your defensive shooting skills. They feature high visibility flake off technology making it easy to see bullet impact. The target has 2:1 size ratio (target at 5 yards represents 6' tall target at 10 yards)





# SILHOUETTE CENTER MASS TARGETS

8 PACK

PRODUCT# 1175522 • UPC# 661120652137

- + HI VISIBILITY FLAKE OFF TECHNOLOGY
- + IDEAL FOR DEFENSIVE SHOOTING SKILL DEVELOPMENT
- + HEAVY CARD STOCK PAPER
- + 12" X 18" TARGET SIZE

The Silhouette Center Mass Targets are perfect for honing your defensive shooting skills. They feature high visibility flake off technology making it easy to see bullet impact. The target has 2:1 size ratio (target at 5 yards represents 6' tall target at 10 yards)



# HIGH CONTRAST PAPER TARGETS

**BLUE 9-DIAMOND SIGHT-IN TARGET**  
PRODUCT# 1175519 • UPC# 661120652106

**DIAMOND SIGHT-IN TARGET**  
PRODUCT# 1175521 • UPC# 661120652113

**BULLSEYE SIGHT-IN TARGET**  
PRODUCT# 1175520 • UPC# 661120652120

- + 10 PER PACKAGE
- + HIGH VISIBILITY COLOR TO SEE AT LONG RANGES
- + DIAMOND SHAPED TARGETS FOR EASY CROSSHAIR ALIGNMENT
- + 1" GRID FOR SIMPLE SCOPE ADJUSTMENTS
- + LARGE 16"X16" TARGET SIZE TO HELP GET ON PAPER

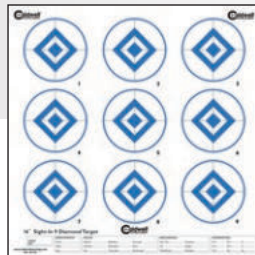

BLUE 9-DIAMOND SIGHT-IN TARGET

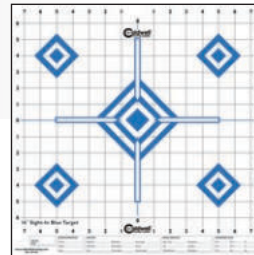

DIAMOND SIGHT-IN TARGET



BULLSEYE SIGHT-IN TARGET



# BALLISTIC PRECISION CHRONOGRAPH WITH BLUETOOTH

PRODUCT# 4001147 • UPC# 661120747482

- + FACTORY CALIBRATED TO +/- 0.25% ACCURACY
- + IDEAL FOR FIREARMS, ARCHERY, AIRGUNS AND PAINTBALL
- + EXTRA WIDE SUN SCREENS FOR ADDED SHADING IN FULL SUN CONDITIONS
- + CONNECTS TO YOUR SMART DEVICE VIA BLUETOOTH

Whether you're testing load accuracy, monitoring the speed of your arrows, or ensuring your paintballs are within field regulation, the Caldwell Ballistic Precision Chronograph is the ideal tool for accurate velocity measurements. Capture shot velocity data via Bluetooth and record environmental conditions and load data in the Caldwell app.



## DOWNLOAD THE FREE APP!

See the velocity of each shot on-screen and record other data such as identifying the load and environmental conditions. The app automatically calculates average velocity, standard deviation, minimum velocity spread and maximum velocity spread for the shot string.



"The Bluetooth" word mark and logos are registered trademarks owned by Bluetooth SIG, Inc. and any use of such marks by AOB Products Company is under license. Other trademarks and trade names are those of their respective owners."



# BALLISTIC PRECISION CHRONOGRAPH WITH BLUETOOTH PREMIUM KIT

PRODUCT# 4001146 • UPC# 661120747499

- + FACTORY CALIBRATED TO +/- 0.25% ACCURACY
- + IDEAL FOR FIREARMS, ARCHERY, AIRGUNS AND PAINTBALL
- + EXTRA WIDE SUN SCREENS FOR ADDED SHADING IN FULL SUN CONDITIONS
- + CONNECTS TO YOUR SMART DEVICE VIA BLUETOOTH
- + KIT INCLUDES: CHRONOGRAPH WITH CARRY CASE, TRIPOD AND LIGHT KIT

Whether you're testing load accuracy, monitoring the speed of your arrows, or ensuring your paintballs are within field regulation, the Caldwell Ballistic Precision Chronograph is the ideal tool for accurate velocity measurements. Capture shot velocity data via Bluetooth and record environmental conditions and load data in the Caldwell app. Premium kit includes the chronograph, carry case, tripod and light kit.



## DOWNLOAD THE FREE APP!

See the velocity of each shot on-screen and record other data such as identifying the load and environmental conditions. The app automatically calculates average velocity, standard deviation, minimum velocity spread and maximum velocity spread for the shot string.



"The Bluetooth" word mark and logos are registered trademarks owned by Bluetooth SIG, Inc. and any use of such marks by AOB Products Company is under license. Other trademarks and trade names are those of their respective owners."





 **CALDWELL®**

**RETURNING PRODUCTS**

# HYDROSLED™

PRODUCT# 1093568 • UPC# 661120417880

- + REDUCE FELT RECOIL UP TO 95% BY FILLING THE ON-BOARD RESERVOIR WITH WATER
- + RACK & PINION ELEVATION RAM ALLOWS FOR PRECISE ADJUSTMENTS WHEN DIALING IN YOUR SCOPE
- + EMPTY THE WATER WHEN FINISHED FOR EASIER PORTABILITY & STORAGE
- + CLEARANCE FOR DETACHABLE MAGAZINES

The Caldwell Hydrosled is the most innovative shooting rest on the market today, eliminating 95% of felt recoil. The Hydrosled has the ability to fill an onboard reservoir with your choice of media. There is no longer the need to carry heavy lead bags or weights to the range. Simply fill the 2-gallon reservoir with water, sand or pebbles, and you are good to go. Hydrosled is adjustable to accommodate nearly all rifles and shotguns including lever action rifles and AR platforms with detachable magazines. This shooting rest utilizes a proven rack and pinion elevation ram for precise adjustments, along with fine windage and elevation adjustment knobs. An advanced rear recoil pad protects the firearm and shooter while the front retention strap eliminates muzzle jump.



patents: aob.com/patents

# LEAD SLED® 3

PRODUCT# 820310 • UPC# 661120001430

- + IDEAL FOR MAGNUM RIFLES AND SLUGS
- + FRONT ELEVATION ADJUSTMENT
- + TRAY ACCOMMODATES UP TO 100LBS OF LEAD SHOT OR TWO 25LB. BARBELL WEIGHTS
- + NON-MARRING SKELETONIZED FRONT REST AND REAR PAD

The Lead Sled 3 has become the standard in weight reduction shooting rests. The Lead Sled 3 reduces felt recoil by up to 95% while securely holding your gun on target. The new Skeletonized front rest secures your gun with its non-marring surfaces. The improved rear buttstock cradle uses top of the line Shock Eliminator Technology and has a non-marring cradle to keep your gun in place. Rear elevation and front fingertip adjusts elevation to allow for precise adjustments.



patents: aob.com/patents

# LEAD SLED® DFT2

PRODUCT# 336677 • UPC# 661120001447

- + DUAL FRAME TECHNOLOGY (DFT) DESIGN DISPERSES MAXIMUM AMOUNT OF RECOIL ENERGY
- + TRAY ACCOMMODATES (2) STANDARD BAGS FILLED WITH 25 LBS OF LEAD SHOT OR ONE LARGE BAG
- + BENCHREST PRECISION ELEVATION AND WINDAGE ADJUSTMENTS
- + ADJUSTABLE CRADLE SYSTEM FITS ALMOST ANY LENGTH RIFLE & SHOTGUN

The Lead Sled DFT 2 (Dual Frame Technology) provides shooters with the industry's best recoil reduction system and the versatility to fit virtually any shotgun or rifle, all built around a precision shooting platform. A key feature of the DFT 2 is the ability to slide the front cradle 18" for optimal length adjustment.



patents: aob.com/patents

# LEAD SLED® SOLO™

PRODUCT# 101777 • UPC# 661120017776

- + PIVOTING ELEVATION ADJUSTMENT DESIGN WITH SINGLE KNOB CONTROL
- + ACCOMMODATES ALL RIFLES, INCLUDING DETACHABLE MAGAZINE RIFLES AND LEVER ACTION GUNS
- + TRAY ACCOMMODATES (1) STANDARD BAG FILLED WITH 25 LBS OF LEAD SHOT
- + RETENTION STRAP SECURES GUN IN FRONT REST

The Lead Sled Solo is the perfect shooting rest for sighting in any rifle or shotgun. Its unique offset frame is designed to accommodate all rifles including those with detachable magazines like the popular AR-15 platform. The heavy-duty steel construction provides a stable and solid shooting platform. A smooth pivoting elevation system is controlled with a single knob making adjusting onto target fast and precise. The front support is height adjustable and has a durable rubberized coating made to not scratch or mark your firearm. A welded steel brace covered with a durable rubber boot secures the butt of the gun while protecting it from abrasions. A strap integrated into the front support can be used to easily secure your rifles forend onto the rest.



patents: aob.com/patents

# LEAD SLED® WEIGHT BAGS

## STANDARD BAG (SINGLE)

PRODUCT# 428334 • UPC# 66112028334

## STANDARD BAG (4 PACK)

PRODUCT# 533117 • UPC# 661120331179

## LARGE BAG (SINGLE)

PRODUCT# 777800 • UPC# 661120778004

- + MADE FOR LEAD SLED SHOOTING RESTS
- + SMALL BAG DESIGNED TO HOLD 7 LBS OF SAND OR 25 LBS OF LEAD SHOT
- + LARGE BAG HOLDS 20 LBS OF SAND
- + DURABLE NYLON-WEBBED HANDLES

The Lead Sled Weight Bags are available in both standard and large sizes. These bags are ideal to use for your Lead Sled 3, Solo or DFT 2. Both conveniently hold lead shot, sand, or other weighted materials. The durable handles make toting your weight bags to the range quick and easy.



STANDARD BAG

Dimensions: 5 1/2"W x 10"H x 3"D

LARGE BAG

Dimensions: 10"W x 16"H x 2 1/2"D

patents: aob.com/patents

# LEAD SLED® FCX™

PRODUCT# 820444 • UPC# 661120204442

- + ADJUST WINDAGE AND ELEVATIONS WITH A SINGLE MOVEMENT
- + 4" COURSE ELEVATION ADJUSTMENT AT THE REST
- + OVERALL SHOOTING REST LENGTH IS ADJUSTABLE
- + CONTOURED REAR SUPPORT PROTECTS GUNSTOCK'S FINISH

The Lead Sled FCX combines the two most innovative gun rest technologies in the industry's most advanced shooting platform. Designed for fast, precise crosshair alignment and smooth function while reducing felt recoil up to 95%. Included is the custom-fit weight bag with carry handle for easy weight transport. The Lead Sled FCX gives you ultimate accuracy and comfort all in one.



patents: aob.com/patents

## FIRE CONTROL® FRONT REST

PRODUCT# 746884 · UPC# 661120468844

- + STAINLESS STEEL LEVELING FEET
- + ELEVATION KNOB SECURELY LOCKS INTO POSITION
- + MACHINED GEARS AND RACKS FOR SMOOTH, PRECISE MOVEMENTS
- + ONE-HAND WINDAGE AND ELEVATION ADJUSTMENTS

Fire Control is an advanced alignment system that allows you continual, one-hand adjustment of downrange crosshair alignment via a multi-directional control arm. It provides you with continuous adjustment of the front forend support by manipulating the control arm with your fingertips. Once the coarse adjustments have been made to position the rest, the control arm allows fluid movement for precise crosshair alignment without having to change shooting position to loosen or tighten rest components. The result is outstanding control of crosshair alignment in a rock-solid shooting platform which delivers better accuracy than any existing rest. This revolutionary development allows accuracy and speed that previously conventional rifle rests can't offer. The continuous precision adjustment of Fire Control allows the crosshairs to easily and quickly be manipulated as you maintain a perfectly relaxed shooting position.

patents: aob.com/patents



## FIRE CONTROL® FULL LENGTH REST

PRODUCT# 100259 · UPC# 661120002598

- + ADJUSTABLE CRADLE EAR ASSEMBLY FOR INCREASED CONTROL AND CONSISTENT CLAMPING PRESSURE
- + DURABLE STEEL TUBES CONNECT FRONT AND REAR BASES
- + ONE-HAND WINDAGE AND ELEVATION ADJUSTMENTS
- + NON-MARRING REAR PAD

Fire Control Full-length Rest combines the Fire Control Front Rest with a non-marring cradle to keep your gun in place. Fire Control is an advanced alignment system that allows you continual, one-hand adjustment of downrange crosshair alignment via a multi-directional control arm. It provides you with continuous adjustment of the front forend support by manipulating the control arm with your fingertips. The result is outstanding control of crosshair alignment in a rock-solid shooting platform which delivers better accuracy than any existing rest. The continuous precision adjustment of Fire Control allows the crosshairs to easily and quickly be manipulated as you maintain a perfectly relaxed shooting position.

patents: aob.com/patents



## ZEROMAX™ SHOOTING REST

PRODUCT# 546889 · UPC# 661120468899

- + DURABLE, NON-MARRING FRONT AND REAR SUPPORTS
- + FOREND CRADLE DESIGNED TO HOLD ALL CALDWELL FRONT REST BAGS
- + MICRO ADJUSTMENT FOR ELEVATION CORRECTION
- + GREAT SHOOTING BASE FOR RIFLES AND SHOTGUNS

The Caldwell Zero-Max Shooting Rest is a full-length metal rest that comes packed with all the features that you demand. Featuring independently adjustable locking feet for precise elevation adjustment, a padded rear cradle and filled front bag to protect your firearms' finish, the Zero-Max shooting rest offers you a rock solid platform that is quick and convenient to set up wherever your next shooting venture takes you.



# 7 REST SHOOTING REST

PRODUCT# 1071001 • UPC# 661120015574

- + AMBIDEXTROUS - FLIPS TO ACCOMMODATE RIGHT OR LEFT-HANDED SHOOTERS
- + OVER-MOLDED SUPPORTS
- + FOLDS COMPACT FOR TRANSPORT AND STORAGE
- + LENGTH FROM FRONT TO REAR SUPPORT: 16"-24"

The 7-Rest is a truly innovative shooting accessory that utilizes its unique design to deliver exceptional versatility and true value. The asymmetric frame provides great stability while maximizing length adjustability. By simply loosening the lock knob, the angle between the two halves of the frame can be adjusted to change the distance between the front and rear supports. Having the frame offset to the side of the gun also gives adequate clearance for extended magazines on semi-autos (AR-15), lever actions and rolling blocks. Another great benefit of the frame design is its ability to be reversible. Fully adjustable front and rear supports hold your gun securely while protecting the stock and forend. It folds quickly for easy transport and storage. All these features rolled into one rest results in a one-of-a-kind shooting base that pairs with any firearm.



# PRECISION TURRET SHOOTING REST

PRODUCT# 821400 • UPC# 661120214007

- + 3 LEG TRIPOD DESIGN FOR MAXIMUM STABILITY
- + MICRO- ADJUSTABLE PISTOL GRIP REST FOR PRECISE ELEVATION ADJUSTMENTS
- + NON-MARRING FOREND CLAMP KEEPS RIFLE SECURE AND CENTERED WITH SWIVEL AND TILT FEATURES
- + FRONT LEG VERTICAL ADJUSTMENT UP TO 6"
- + BALL BEARING PANNING SYSTEM WITH A 58-DEGREE ARC USING A GUN WITH AN EXTENDED MAGAZINE

Find comfort in having full range of motion and secure gun placement with the Caldwell Precision Turret Shooting Rest. The swivel/pan and tilt knobs eliminate time wasted readjusting the shooting rest, so you can spend more time shooting. This heavy duty rest features a forend clamp and micro-adjustable pistol grip attachment that are perfect for AR platform firearms.



patents: aob.com/patents

# STINGER™ SHOOTING REST

PRODUCT# 110033 • UPC# 661120000402

- + INNOVATIVE ELEVATION SYSTEM ALLOWS FOR FAST ONE HANDED, NO WOBBLE ADJUSTMENT
- + MICRO ELEVATION ADJUSTMENTS WITH FINGERTIP CONTROL
- + UP TO 3" FRONT REST VERTICAL ADJUSTMENT
- + OVERMOLDED, NON-MARRING FRONT AND REAR CRADLES

The Stinger Shooting Rest is built with a state of the art design. Central to the design is the innovative front elevation system. It's user-friendly height adjustment knob allows for fast, one handed coarse elevation adjustment. The molded front and rear supports protect the gun's finish and provide just the right amount of firmness for rock solid shots. A heavy-duty dual metal frame and quick cam locks allow the Stinger's front rest to easily slide forward or backwards then lock in place. The Stinger Shooting Rest provides versatility and ultimate stability, delivering you maximum accuracy.



patents: aob.com/patents

# THE ROCK BR™

PRODUCT# 440907 • UPC# 661120409076

- + UP TO 11.5" VERTICAL ADJUSTMENT
- + ADJUSTABLE FRONT BAG TENSION SYSTEM
- + PRECISION FINGERTIP WINDAGE SYSTEM
- + INCLUDES UNFILLED 3-LOBE BAG AND FILLED MEDIUM VARMINT FRONT BAG
- + MACHINED DIE-CAST METAL CONSTRUCTION

The Rock BR will help you discover the true potential of your rifle and ammunition. This high quality rest is designed for the most accuracy-minded shooters around, bench rest competitors. Now everyone who wants the best from their rifle can benefit from the advanced design, precision machining, and finely engineered features of The Rock BR.

patents: aob.com/patents



# THE ROCK™

PRODUCT# 383774 • UPC# 661120399766

- + UP TO 7.25" VERTICAL ADJUSTMENT
- + WIDE 3-POINT IRON BASE FOR EXTRA STABILITY
- + FOREND CRADLE ACCEPTS ALL CALDWELL DELUXE UNIVERSAL FRONT REST BAGS
- + FILLED MEDIUM VARMINT FRONT BAG INCLUDED

The best way to determine the accuracy of your rifle and ammunition is to shoot them from a solid bench with a quality shooting rest. Featuring cast iron construction, independently adjustable feet, and an adjustable and lockable forend rest, The Rock helps you eliminate the variables that make you miss.



# THE ROCK™ COMBO

PRODUCT# 383640 • UPC# 661120836407

- + COMBO INCLUDES THE ROCK SHOOTING REST AND DEADSHOT® REAR SHOOTING BAG
- + UP TO 7.25" VERTICAL ADJUSTMENT
- + WIDE 3-POINT IRON BASE FOR EXTRA STABILITY
- + FOREND CRADLE ACCEPTS ALL CALDWELL DELUXE UNIVERSAL FRONT REST BAGS
- + FILLED MEDIUM VARMINT FRONT BAG INCLUDED

The best way to determine the accuracy of your rifle and ammunition is to shoot them from a solid bench with a quality shooting rest. Featuring cast iron construction, independently adjustable feet, and an adjustable and lockable forend rest, The Rock helps you eliminate the variables that make you miss.





## THE ROCK JR.™

PRODUCT# 323225 • UPC# 661120232254

- + STABLE, 4 LB. CAST IRON BASE, OVERALL 5 LBS.
- + 3/4" DIAMETER STEEL POST PROVIDES SECURE AND SMOOTH ELEVATION ADJUSTMENTS UP TO 7 1/4" HEIGHT
- + COMES WITH INTERCHANGEABLE NON-SLIP RUBBER FEET OR METAL SPIKE FEET
- + FILLED MEDIUM VARMINT FRONT BAG INCLUDED WITH REST

The Rock Jr. features many of the same trademarks as The Rock Shooting Rest but in a sleeker and more compact package. When it comes to sighting-in, test firing, and informal competition, it's tough to beat The Rock Jr.



## BR FOOT PADS

PRODUCT# 845221 • UPC# 661120452218

- + RUBBER-COATED METAL WASHERS BUILT TO HOLD THE ROCK BR™ SPIKED FEET
- + PROVIDES NON-SLIP BASE
- + NON-MARRING ON TABLETOP SURFACE
- + SET OF 3

BR feet pads are designed to provide a stable, non-marring solution that keep the spiked metal feet of your rest from gouging or scratching the tabletop of your shooting bench. BR feet are rubber coated, metal washers that allow the shooting rest's spiked metal feet to nest in the washer. This provides a firm, no-slip footprint while protecting your tabletop.

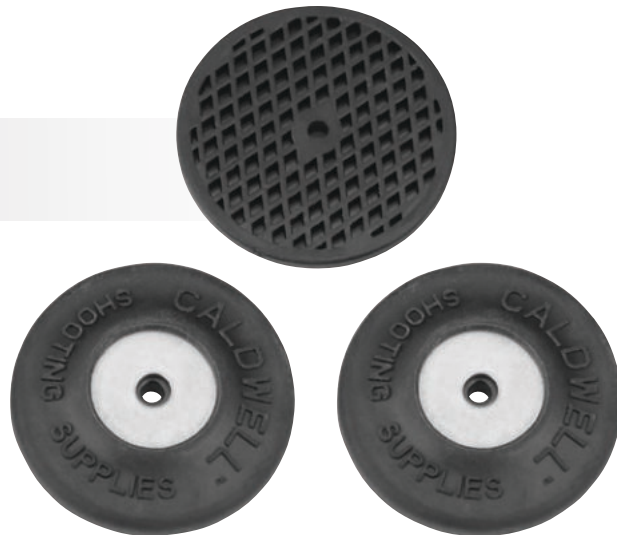

## MATRIX™

PRODUCT# 101600 • UPC# 661120016007

- + ONE-HANDED ELEVATION ADJUSTMENT KNOB
- + UP TO 4.5" GUN LENGTH ADJUSTMENT
- + OVERMOLDED, NON-MARRING FRONT AND REAR CRADLES
- + REMOVE REAR CRADLE TO ACCOMMODATE HANDGUNS

The highly versatile Matrix combines great features and rock-solid stability in an affordable rest. Central to the design is the innovative, ultra-rigid u-channel frame which allows for quick adjustment in length to perfectly fit any firearm. A convenient storage area incorporated behind the front cradle features a removable lid that adds additional clearance for detachable magazines or bipod equipped firearms when detached, and acts as a rubberized rear support surface for firing handguns when left in place. A spring-loaded tension mechanism and height adjustment knob are great for fast, one handed elevation adjustments keeping the front cradle wobble free through the entire vertical range.



## PISTOLERO™

PRODUCT# 562771 • UPC# 661120627715

- + ONE-HANDED ELEVATION ADJUSTMENT KNOB
- + UP TO 4.5" GUN LENGTH ADJUSTMENT
- + OVERMOLDED, NON-MARRING FRONT AND REAR CRADLES
- + REMOVE REAR CRADLE TO ACCOMMODATE HANDGUNS

The Pistolero is the ideal handgun shooting rest. By combining 5 inches of horizontally adjustable hand support with 3 inches of vertically adjustable barrel support, this rest accommodates virtually every size handgun. In addition, the rugged construction of this rest is virtually impervious to the elements. This combination of versatility, stability and durability make the Pistolero™ the number one value in handgun rests.

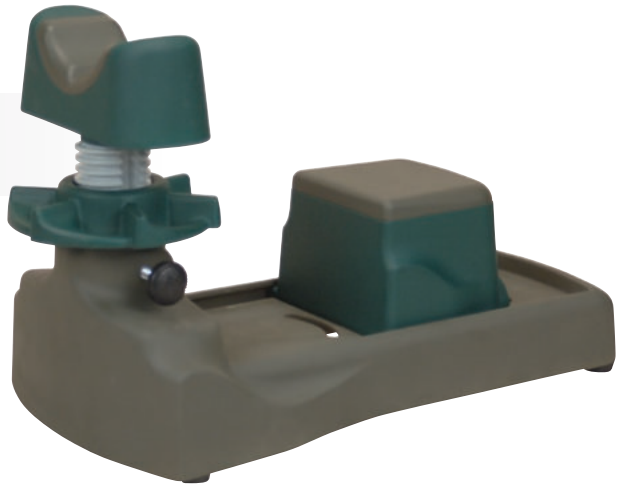

## HANDY REST NXT®

PRODUCT# 574662 • UPC# 661120746621

- + 3" OF ELEVATION ADJUSTMENT AT THE CRADLE WHICH EQUATES TO 6' AT 100 YARDS
- + FRONT SLING STUD CLEARANCE GROOVE
- + CONSTRUCTED OF DURABLE LIGHTWEIGHT POLYMER WITH RUBBER OVERMOLDING
- + REMOVABLE HANDGUN SUPPORT ATTACHMENT TO CONVERT RIFLE REST INTO A HANDGUN REST
- + LOCK KNOB TO LOCK YOUR ADJUSTMENTS INTO PLACE FOR REPEATABLE ACCURACY

The Handy Rest NXT is an extremely versatile front rest. It is designed with a full six feet of elevation adjustment at 100 yards, a front sling stud clearance groove, and is constructed of durable, lightweight materials. The innovative design includes a removable handgun support attachment that easily converts this rifle rest into a handgun rest. The front rest and handgun support feature a material that will not harm firearms yet also offers a steady shooting surface.



## STEADY REST NXT®

PRODUCT# 548664 • UPC# 661120486640

- + FRONT SECTION ALONE CAN BE USED AS A HANDGUN REST
- + SPANNER SECTION IS REMOVABLE TO TURN THE NXT® INTO A FRONT AND REAR REST
- + NEOPRENE PAD PROVIDES A FIRM, CUSHIONED BASE FOR YOUR FAVORITE PISTOL OR REVOLVER
- + OVERALL LENGTH OF REST IS 26"
- + 3" OF VERTICAL CRADLE ADJUSTMENT

The Steady Rest NXT gives you a steady, elevation-adjustable platform for sighting in rifles, pistols and patterning shotguns. The three-piece design allows the shooter to use the rest in one or two-piece configurations, allowing it to adjust the rest to any length long gun as well as handguns. The front and rear supports feature a non-marring material that is gentle on your firearm's finish yet is firm enough to provide a stable shooting surface.

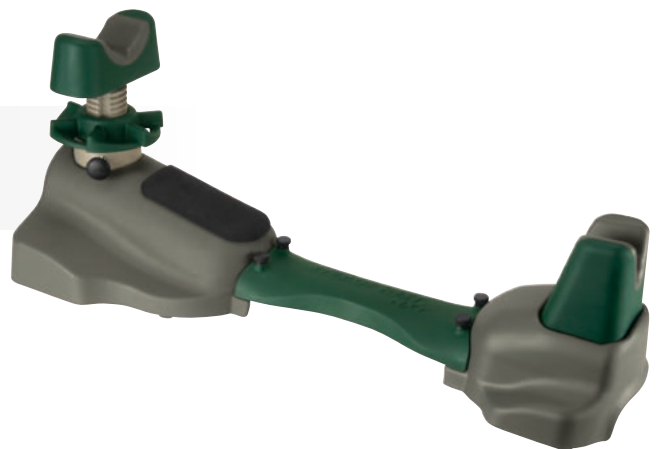

## STABLE TABLE®

PRODUCT# 252552 · UPC# 661120525523

- + HIGHLY DURABLE, WEATHERPROOF 34"X23" SYNTHETIC TABLE TOP
- + QUICK-RELEASE PIN FOR EASY SEAT HEIGHT ADJUSTMENT
- + TABLE TOP AND SEAT PIVOTING CAN BE LOCKED
- + TWO CLEANING FORKS ARE INCLUDED, ONE FOR FORE-ENDS AND ONE FOR BUTTSTOCKS

The Stable Table is purpose-built to be the finest value-priced shooting bench in the market. The tripod design is more rigid and has fewer joints than folding-style benches and is appropriate for a wide variety of shooting conditions and disciplines. A bolt in the base allows position adjustment of a single leg, leveling the tabletop. The central shaft, seat, and tabletop pivot around a center axis as a single unit while keeping the tabletop parallel to the horizon. The top is made from molded plastic with a rigid metal under-frame. The seat adjusts from 16" to 22" and rotates in tandem with the tabletop. Convenient cleaning forks are included that snap into position in the top and securely hold a gun for cleaning.



Cleaning Forks

## STABLE TABLE® CARRY BAG

PRODUCT# 777810 · UPC# 661120778103

- + CARRIES CALDWELL STABLE TABLE CONVENIENTLY
- + FULL WRAP AROUND SHOULDER STRAPS
- + HEAVY-DUTY CONSTRUCTION WITH DOUBLE LAYER FABRIC AND PADDED LOWER PORTION
- + INNER BAG FOR THE TABLE HUB INCLUDED

This heavy-duty carrying bag will hold all pieces of your Stable Table and allows for convenient transport to the range or field. Full wrap shoulder straps, double layer fabric, heavy duty zipper and padded lower portion ensures maximum durability and protection for your Stable Table.



## STABLE TABLE® LITE

PRODUCT# 1084745 · UPC# 661120414360

- + AMBIDEXTROUS, ROTATING SEAT, COUPLED WITH TABLE DEPTH ADJUSTMENT, FOR MAXIMUM SHOOTING COMFORT
- + FULLY COLLAPSIBLE FOR EASY TRANSPORTATION AND STORAGE
- + ALL-WEATHER TABLETOP AND SEAT
- + CAN SUPPORT UP TO 250 POUNDS OF WEIGHT
- + WEIGHS LESS THAN 30 POUNDS

Wish you could conveniently bring your own shooting table to the range? Now you can with the Stable Table Lite. This shooting table is lightweight and durable making it the perfect solution to overcrowded or rundown ranges. Setup and adjustments are fast and simple with a rotating seat and table depth adjustment to ensure maximum shooting comfort. No matter if it's raining, snowing, the shooter is right handed or left handed, this table is ready for all situations with its ambidextrous seat pivots and all-weather tabletop and seat.



# BR PIVOT® PREMIUM SHOOTING BENCH

PRODUCT# 300015 • UPC# 661120000150

- + LIGHTWEIGHT ALUMINUM CENTER POST WITH PRECISION MACHINED ENDS FOR TIGHT-TOLERANCE FIT
- + TABLE TOP AND SEAT CAN SWIVEL 360°, EITHER IN UNISON OR INDEPENDENTLY
- + STURDY FEET SPREAD CONTACT OVER A WIDER AREA
- + QUICKLY AND EASILY BREAKS DOWN FOR STORAGE/TRANSPORTATION
- + FLIP THE HARDWOOD MAPLE TOP AND MOUNT IT FOR LEFT HANDED SHOOTERS

The BR Pivot is the finest shooting bench available. It combines the best materials, an unparalleled design and years of thinking, field use, and continuous development into a complete package that is ready for a lifetime of service. The BR Pivot is bombproof, foolproof and ready for users who are serious about accuracy. The padded seat can be adjusted for any height between 16" and 27". The bench breaks down into four pieces and weighs a total of 65 pounds. The weight limit of the BR Pivot is 250 pounds, which does not include the weight of the shooting rest, firearm and accessories.



# TACK DRIVER® SHOOTING REST

## FILLED BAG

PRODUCT# 569230 • UPC# 661120692300

## UNFILLED BAG

PRODUCT# 191743 • UPC# 661120917434

- + SELF-TIGHTENING SURFACE GRIPS YOUR RIFLE AND REDUCES FELT RECOIL
- + NON-MARRING, NON-SLIP SURFACE WILL NOT HARM YOUR RIFLE'S FINISH
- + SUPPORTS ALMOST ANY RIFLE OR SHOTGUN TYPE
- + CONVENIENT CARRY HANDLE

The most user-friendly and effective, one-piece shooting bag available. This convenient shooting bag takes the place of two. You can use the Tack Driver almost anywhere, from portable and permanent shooting benches to makeshift positions in the field.



# HUNTER'S BLIND BAG

PRODUCT# 247261 • UPC# 661120472612

- + IDEAL FOR DEER/TURKEY STANDS, FENCE POSTS, TREE LIMBS OR TRUCK BED SIDES
- + BAG IS TRIM, LIGHTWEIGHT, EASY-FILLING AND WILL NOT SAG OVER TIME
- + NARROW CONTOUR OF REST MATCHES MOST SPORTER WEIGHT STOCKS

Support and protect your rifle in almost any hunting situation. The Caldwell Blind Bag is the answer when other types of support are unavailable or inappropriate. Quick set-up for accurate shooting when the need for a stable rest is at a premium.



# DEADSHOT® SHOOTING BAGS

## FRONT SHOOTING BAG

PRODUCT# 516620 • UPC# 661120006572

## REAR SHOOTING BAG

PRODUCT# 640721 • UPC# 661120006541

- + MADE OF DURABLE, WATER-RESISTANT 600 DENIER POLYESTER
- + FRONT SHOOTING BAG IS THE INDUSTRY'S LARGEST (APPROXIMATELY 8 LBS.)
- + QUICK-CONNECT FEATURE MAKES BAG TRANSPORT EASY

Every hunter and shooter is looking for a versatile and steady shooting system that can be set up almost anywhere, and at any time. Whether you have minutes or seconds to set up for your next shot, the DeadShot Shooting Bags are the answer. These inexpensive and functional bags continue to set the industry standard for quality and functional shooting bags.



REAR BAG



FRONT BAG

# DEADSHOT® SHOOTING BAG COMBO

## FILLED BAGS

PRODUCT# 939333 • UPC# 661120393337

## UNFILLED BAGS

PRODUCT# 248885 • UPC# 661120488859

- + MADE OF DURABLE, WATER-RESISTANT 600 DENIER POLYESTER
- + FRONT SHOOTING BAG IS THE INDUSTRY'S LARGEST (APPROXIMATELY 8 LBS.)
- + QUICK-CONNECT FEATURE MAKES BAG TRANSPORT EASY

Every hunter and shooter is looking for a versatile and steady shooting system that can be set up almost anywhere, and at any time. Whether you have minutes or seconds to set up for your next shot, the DeadShot Shooting Bags are the answer. These inexpensive and functional bags continue to set the industry standard for quality and functional shooting bags.



# SHOOTING REST FRONT BAGS

## NARROW SPORTER

PRODUCT# 108325 • UPC# 661120083252

## MEDIUM VARMINT

PRODUCT# 263234 • UPC# 661120632344

## WIDE BENCHREST

PRODUCT# 576578 • UPC# 661120765783

- + AVAILABLE IN A VARIETY OF WIDTHS TO FIT DIFFERENT RIFLE STOCK PROFILES
- + FILLING PORT ALLOWS FOR A CUSTOMIZED FIT BY ADDING OR REMOVING MEDIA
- + CONSTRUCTED FROM NON-STRETCH POLYESTER AND HIGH-QUALITY LEATHER
- + HOOK AND LOOP TABS PROVIDES A SECURE FIT

These innovative, high-quality leather and polyester Front Shooting Bags function with most brands of front rests. The hook and loop tabs on the bags allow quick installation and removal from the cradle without time-consuming need to lace them on. The leather gives you a secure rest and the polyester, which will not stretch or sag, allows the bag to hold it's shape. This combination makes for the best shooting bag on the market.



NARROW SPORTER



MEDIUM VARMINT



WIDE BENCHREST

# UNIVERSAL BENCH BAGS

## ELBOW BAG

PRODUCT# 774317 • UPC# 661120743170

## UNIVERSAL BAG

PRODUCT# 116375 • UPC# 661120163756

- + THE UNIVERSAL BAG CAN BE USED AS A FOREARM OR ELBOW REST OR TO RAISE THE HEIGHT OF THE REAR BAG
- + THE ELBOW BAG SAVES WEAR AND TEAR ON ELBOWS / FOREARMS.
- + CONSTRUCTED FROM NON-STRETCH POLYESTER AND HIGH-QUALITY LEATHER

What began as an improvement over the classic front rest bags has been expanded to include a variety of accessory bags for informal as well as competitive shooting. The leather gives you a secure rest and the polyester, which will not stretch or sag, allows the bag to hold its shape. This combination makes for the best shooting bag on the market.



**ELBOW BAG**  
Dimensions: 7"L x 7"W x 1 3/4"H



**UNIVERSAL BAG**  
Dimensions: 5"L x 8"W x 2 1/4"H

# REAR SHOOTING BAGS

- + STANDARD REAR BAG: FOR USE WITH THE 4" CENTER POST ON THE ROCK AND OTHER SIMILAR RESTS
- + MEDIUM-HIGH REAR BAG: FOR USE WITH THE FIRE CONTROL FRONT REST AND OTHER SIMILAR RESTS
- + MAGNUM EXTENDED REAR BAG BAG: FOR USE WITH EXTENDED HEIGHT SHOOTING RESTS
- + UNFILLED BAGS SHOULD BE FILLED WITH DRY SILICA SAND OR OTHER INERT FILLERS

These innovative, high-quality leather and polyester Rear Shooting Bags function with most brands of front rests. The leather gives you a secure rest and the polyester, which will not stretch or sag, allows the bag to hold its shape.



**STANDARD**  
PRODUCT# 598458 • UPC# 661120984580



**STANDARD (UNFILLED)**  
PRODUCT# 226645 • UPC# 661120266457

**MEDIUM-HIGH**  
PRODUCT# 800888 • UPC# 661120008880



**MAGNUM EXTENDED**  
PRODUCT# 445389 • UPC# 661120453895

# AR DEADSHOT® TACTICAL BAG SET

PRODUCT# 934693 • UPC# 661120346937

- + PERFECT SHOOTING HEIGHT WITH PLENTY OF CLEARANCE FOR 30 ROUND MAGAZINE
- + RIFLE CAN EASILY BE ROTATED FOR FAST MAGAZINE CHANGES
- + WORKS GREAT WITH TACTICAL STYLE BOLT ACTION RIFLES AS WELL
- + EXTREMELY HEAVY-DUTY BALLISTIC NYLON RESISTS SCUFFING FROM SHARP EDGED PIC RAILS

The DeadShot Tactical Bag Set was designed to deliver an optimal, stable shooting platform for all AR-15 and AR-10 rifle platforms. The innovative dual configuration rear bag can be oriented for M4 carbine style stocks or reversed for an ideal fit with A2 style stocks. The tall profile front bag is an ideal height for AR allowing clearance for 30 round magazines. Both bags feature an extremely heavy Ballistic Nylon on the contact surfaces designed to hold up to abuse from hand guards with sharp edged pic rails. Bags are pre-filled and ready for use.



# TACK DRIVER® X SHOOTING BAGS

## TACK DRIVER® X

PRODUCT# 1102665 • UPC# 661120417866

## TACK DRIVER® X MINI

PRODUCT# 1102666 • UPC# 661120075684

## TACK DRIVER® PROP BAG

PRODUCT# 1102667 • UPC# 661120418573



X MINI



X BAG



X PROP BAG

- + MOST VERSATILE SHOOTING BAG ON THE MARKET MAKING THESE GREAT FOR PRS MATCHES, SIGHTING IN OR HUNTING
- + PLASTIC PELLET FILLING IS NON-ABSORBENT AND ENHANCES STABILITY WHILE SHOOTING
- + DURABLE CONSTRUCTION FOR LONG SERVICE LIFE
- + UNIQUE SHAPE ALLOWS FOR MULTIPLE REST OPTIONS

The Tack Driver X Bag provides a stable shooting position, no matter the situation. The non-absorbent plastic pellet filling can be customized for any shooter's preference by pouring out the media for a looser fill. Tack Driver X shooting bags feature a durable construction, enhancing shooting stability for the long-term. The Prop Bag can be used to support your arm or to raise the rear of the gun. Elastic straps allow for attaching the bag to your arm or rifle. A carabiner clip is included to attach the bag to your belt or sling.

# BALLISTIC PRECISION CHRONOGRAPH G2

PRODUCT# 720002 • UPC# 661120200024

- + 18" SENSOR SPACING FOR MAXIMUM ACCURACY
- + FACTORY CALIBRATED TO WITHIN +/- 0.25% ACCURACY
- + METERS PER SECOND (MPS) OR FEET PER SECOND (FPS) READINGS
- + APP DISPLAYS VELOCITY, LOGS DATA, NOTES, WEATHER CONDITIONS AND EXPORTS VIA SMS OR EMAIL
- + MEASURES FROM 5 TO 9,999 FPS

The Ballistic Precision G2 literally flips conventional chronograph technology upside down. By inverting the system the G2 is capable of measuring in adverse light conditions making the measurements more accurate than conventional chronographs, even indoors. Collapsible and compact, the system is quick and easily deployed from its heavy duty storage case. Higher accuracy is achieved by using a high speed 48 MHz processor and by designing a circuit with an advanced data interface that allows each unit to be computer calibrated at the factory after assembly.



Tripod, Rechargeable Li-ion battery & 120/220v compatible charger included



## DOWNLOAD THE FREE APP!

See the velocity of each shot on-screen and record other data such as identifying the load and environmental conditions. The app automatically calculates average velocity, standard deviation, minimum velocity spread and maximum velocity spread for the shot string.



# BALLISTIC PRECISION SIGHT-IN TARGET CAMERA

PRODUCT# 1099107 • UPC# 661120417897

- + STREAMS LIVE 720P HD VIDEO UP TO 440 YARDS AWAY
- + INTEGRATED RECHARGEABLE LITHIUM ION BATTERIES FOR EXTENDED USE
- + FEATURES AN EXTERNAL POWER JACK FOR MORE PERMANENT INSTALLATION
- + BREAKS DOWN INTO A COMPACT STORAGE CASE FOR EASY TRANSPORT

The Ballistic Precision Sight-In Target Camera lets you spend more time shooting and less time walking. Whether you are preparing for competition season or hunting season, this easy to use setup is perfect for getting dialed in. Download the free app available in the Apple or Android stores and enjoy real time, 720p high definition video streamed directly to your device. The app also allows you to take pictures, record video and calculate group size. A rechargeable lithium ion battery lasts up to 6 hours. The fully contained, waterproof housing for both the camera and the transmitter allow for use in all weather conditions and the included storage case makes for easy transport.



## DOWNLOAD THE FREE APP!

View your shots, record video, take video stills and even record/save notes without leaving the bench. The app even has a group calculation feature that tells you the grouping size!



# BALLISTIC PRECISION LONG RANGE TARGET CAMERA

PRODUCT# 156726 • UPC# 661120567264

- + STREAMS LIVE 720P HD VIDEO UP TO 1 MILE AWAY
- + INTEGRATED RECHARGEABLE LITHIUM ION BATTERIES FOR EXTENDED USE
- + FEATURES AN EXTERNAL POWER JACK FOR MORE PERMANENT INSTALLATION
- + BREAKS DOWN INTO A COMPACT STORAGE CASE FOR EASY TRANSPORT

The Ballistic Precision Long Range Target Camera was designed by our team of engineers to be the best target camera system available today. The one mile range delivers live streaming HD video footage of your target to your smart phone or tablet through Caldwell's free app. The app allows you to take pictures, record video and calculate your group size. The rechargeable lithium ion battery allows you to use the Target Camera for up to 6 hours. If a more permanent setup is desired it features an external power jack to hook up to an alternative power source. A premium storage case is included to store the entire system.



## DOWNLOAD THE FREE APP!

View your shots, record video, take video stills and even record/save notes without leaving the bench. The app even has a group calculation feature that tells you the grouping size!



# ACCUMAX® PREMIUM CARBON FIBER SWIVEL STUD BIPODS

## 6"-9" BIPOD

PRODUCT# 1092515 • UPC# 661120416166

## 9"-13" BIPOD

PRODUCT# 1092516 • UPC# 661120416272

## 13"-30" BIPOD

PRODUCT# 1095201 • UPC# 661120417750

- + CARBON FIBER LEGS ARE SUPER STRONG AND LIGHTWEIGHT, WITH NON-SLIP RUBBER FEET
- + TWIST-LOCKS FOR FAST INCREMENTAL LEG LENGTH ADJUSTMENT
- + LEGS LOCKOUT FORWARD, 90 DEGREE, OR BACKWARD WITH SPRING-LOADED BUTTONS
- + SECURE LEGS STOPS PREVENT LEGS FROM OVEREXTENDING

Achieve maximum accuracy with the Caldwell Accumax Carbon Fiber Bipod. The Accumax Premium Carbon Fiber Bipod attaches for easy and secure lock-up. The Premium Carbon Fiber Bipod also features an omni-directional ball mount for 360 degree panning, a lever lock handle for fast adjustments, and of course, twist-lock leg length adjustments.



# ACCUMAX® PREMIUM CARBON FIBER M-LOK® / KEYMOD BIPODS

## 6"-9" BIPOD

PRODUCT# 1081953 • UPC# 661120413059

## 9"-13" BIPOD

PRODUCT# 1082223 • UPC# 661120413073

## 13"-30" BIPOD

PRODUCT# 1095203 • UPC# 661120417736

- + M-LOK AND KEYMOD ADAPTER FOR EASY AND SECURE LOCK-UP
- + QUICK-DEPLOYMENT CARBON FIBER LEGS WITH VERTICAL TWIST-LOCK TECHNOLOGY
- + LEG ANGLE ADJUSTMENT UP TO 180 DEGREES WITH STAINLESS STEEL PUSH-BUTTON LEG LOCK
- + SOFT RUBBER FEET FOR ENHANCED STABILITY

Achieve maximum accuracy with the Caldwell Accumax Carbon Fiber Bipod. The Accumax Premium Carbon Fiber Bipod attaches for easy and secure lock-up. It features quick-deployment carbon fiber legs with 90 degree forward locking method or backward method with spring-loaded buttons. The Premium Carbon Fiber Bipod also features an omni-directional ball mount for 360 degree panning, a lever lock handle for fast adjustments, and of course, twist-lock leg length adjustments.





# ACCUMAX<sup>®</sup> PREMIUM CARBON FIBER PICATINNY RAIL BIPODS

## 6"-9" BIPOD

PRODUCT# 1081952 • UPC# 661120413042

## 9"-13" BIPOD

PRODUCT# 1082222 • UPC# 661120413066

## 15"-30" BIPOD

PRODUCT# 1095202 • UPC# 661120417743

- + PICATINNY RAIL ATTACHMENT FOR EASY AND SECURE LOCK-UP
- + QUICK-DEPLOYMENT CARBON FIBER LEGS WITH VERTICAL TWIST-LOCK TECHNOLOGY
- + LEG ANGLE ADJUSTMENT UP TO 180 DEGREES WITH STAINLESS STEEL PUSH-BUTTON LEG LOCK
- + SOFT RUBBER FEET FOR ENHANCED STABILITY

Achieve maximum accuracy with the Caldwell Accumax Carbon Fiber Bipod. The Accumax Premium Carbon Fiber Bipod attaches for easy and secure lock-up. It features quick-deployment carbon fiber legs with 90 degree forward locking method or backward method with spring-loaded buttons. The Premium Carbon Fiber Bipod also features an omni-directional ball mount for 360 degree panning, a lever lock handle for fast adjustments, and of course, twist-lock leg length adjustments.



# XLA<sup>®</sup> M-LOK<sup>®</sup> / KEYMOD BIPODS

## 6"-9" BIPOD

PRODUCT# 1081950 • UPC# 661120413028

## 9"-13" BIPOD

PRODUCT# 1081951 • UPC# 661120413035

- + LOWEST PROFILE BIPOD MOUNT AVAILABLE
- + M-LOK<sup>®</sup> AND KEYMOD ADAPTER FOR USE ON POLYMER HAND GUARDS
- + LIGHTWEIGHT AND STURDY ALUMINUM CONSTRUCTION
- + LEGS ARE NOTCHED FOR EASY INDEXING TO A SPECIFIC HEIGHT
- + TWIST-LOCK TECHNOLOGY FOR LOCKING LEGS BETWEEN NOTCHES

As the lowest profile bipod mount available, the Caldwell M-LOK/Keymod XLA Bipod is lightweight, sturdy and ready for all situations. Shoot with confidence while utilizing the heavy duty aluminum construction, quick-deployment legs and soft rubber feet for enhanced stability. This tactical rifle bipod features everything needed to securely fit your rifle and create the ideal shooting experience.



M-LOK<sup>®</sup> ADAPTER



KEYMOD ADAPTER



# XLA<sup>®</sup> PICATINNY RAIL BIPODS

## 6"-9" BIPOD

PRODUCT# 110140 • UPC# 661120001553

## 9"-13" BIPOD

PRODUCT# 110141 • UPC# 661120001560

- + LIGHTWEIGHT ADJUSTABLE ALUMINUM DESIGN
- + ADJUSTABLE LEG HEIGHT FOR THE PERFECT POSITIONING
- + SOFT RUBBER FEET FOR ENHANCED STABILITY
- + COLLAPSIBLE FOR TRANSPORT OR TO LEAVE ON YOUR GUN
- + SPRING LOADED LEGS WITH LOCK OUT KNOBS

The Caldwell Pic Rail XLA Fixed Bipods provide a stable shooting platform that conveniently attaches to any Pic Rail. The Pic Rail XLA Fixed Bipods feature a light weight aluminum design, quick deployment with spring loaded legs, adjustable leg height for perfect positioning and soft rubber feet for enhanced stability. The cam over lever secures the bipod to the pic rail firmly, and is collapsible for leaving on your firearm for easy transport.



## XLA® SWIVEL STUD PIVOT BIPODS

6"-9" (BLACK)

PRODUCT# 247142 • UPC# 661120471424

9"-13" (BLACK)

PRODUCT# 571429 • UPC# 661120714293

9"-13" (CAMO)

PRODUCT# 445033 • UPC# 661120450337

13"-23" (BLACK)

PRODUCT# 701417 • UPC# 661120014171

13.5"-27" (BLACK)

PRODUCT# 635705 • UPC# 661120357056

13.5"-27" (CAMO)

PRODUCT# 445088 • UPC# 661120450887

- + 18 DEGREE DIRECTIONAL CANT LEFT OR RIGHT
- + LEGS INSTANTLY SPRING-OUT WITH THE TOUCH OF A BUTTON
- + LEGS COLLAPSE FORWARD FOR TRANSPORT
- + NON-SLIP RUBBER FEET FOR ENHANCED STABILITY
- + PADDED BASE PROTECTS FIREARM FOREND

The Caldwell® XLA Bipods provide a stable shooting support that conveniently attaches to almost any firearm with a sling swivel stud. The lightweight aluminum design adds minimal weight and deploys quickly, with legs that instantly spring out to the shooting position with the touch of a button. The legs are notched for easy indexing to a specific height. There is a connection point for sling attachment and multi section legs that collapse forward allowing for convenient carry of the firearm. Durable rubber feet provide enhanced stability, while the padded bipod base protects the firearm's forend.



## XLA® SWIVEL STUD FIXED BIPODS

6"-9" (BLACK)

PRODUCT# 379852 • UPC# 661120798521

9"-13" (BLACK)

PRODUCT# 403215 • UPC# 661120032151

13"-23" (BLACK)

PRODUCT# 591336 • UPC# 661120913368

- + LEGS INSTANTLY SPRING-OUT WITH THE TOUCH OF A BUTTON
- + LEGS COLLAPSE FORWARD FOR TRANSPORT
- + NON-SLIP RUBBER FEET FOR ENHANCED STABILITY
- + PADDED BASE PROTECTS FIREARM FOREND

The Caldwell XLA Bipods provide a stable shooting support that conveniently attaches to almost any firearm with a sling swivel stud. The lightweight aluminum design adds minimal weight and deploys quickly, with legs that instantly spring out to the shooting position with the touch of a button. The legs are notched for easy indexing to a specific height. There is a connection point for sling attachment and multi section legs that collapse forward allowing for convenient carry of the firearm. Durable rubber feet provide enhanced stability, while the padded bipod base protects the firearm's forend.



## PIC RAIL ADAPTER PLATE

PRODUCT# 156716 • UPC# 661120567165

- + ABILITY TO ALIGN THE ADAPTER WITH THE BARREL INSTEAD OF THE STOCK
- + SIMULTANEOUSLY UTILIZES SHOULDER SLING AND A PIC RAIL MOUNTED ACCESSORY
- + ADJUSTABLE TENSION AND VERTICAL ANGLE

The Caldwell Pic Rail Adapter is perfect for utilizing both your shoulder sling and a pic rail mounted accessory at the same time. By adjusting the tension on the front and rear T20 screws you can change the vertical angle of the Pic Rail Adapter to align with the barrel instead of the stock. A curved "fore-end style" profile ensures a perfect mating surface for the bipod.



# BIPOD PIVOT LOCK

PRODUCT# 535881 • UPC# 661120358817

- + SPRING LOADED "PULL" OUT FOR EASY HANDLE POSITIONING
- + SECOND ADAPTER FOR SAE #10-32 THREADED EXTERNAL SPRING BIPODS
- + "C" IDENTIFIES THE CALDWELL® ADAPTER FROM THE SAE ADAPTER
- + EASILY ADJUST PIVOT TENSION WHILE STILL SHOULDERING YOUR RIFLE

The Caldwell Bipod Pivot Lock works on all XLA Bipod Pivot models. It also fits most other brand bipods and includes a #10-32 threaded adapter for SAE threaded pivot model bipods. Easily adjust the tension of your pivot mount without tools!



# BIPOD ADAPTER FOR PICATINNY RAIL

PRODUCT# 535423 • UPC# 661120354239

- + ATTACH ANY TRADITIONAL BIPOD OR SLING TO A PICATINNY RAIL
- + LIGHT-WEIGHT, DURABLE MACHINED ALUMINUM CONSTRUCTION
- + TWO INTEGRATED FASTENERS ENSURE A SECURE ATTACHMENT

The Bipod Adapter quickly and easily attaches to a picatinny rail. Any standard bipod and sling can be attached to the integrated swivel stud. A curved "fore-end style" profile assures the perfect fit for the bipod to mate with.



# AR BIPODS

**7.5"-10" PRONE (BLACK)**  
PRODUCT# 531123 • UPC# 661120311232

**7.5"-10" PRONE (TAN)**  
PRODUCT# 534455 • UPC# 661120344551

**14.5"-30" SITTING (BLACK)**  
PRODUCT# 532255 • UPC# 661120322559

- + QUICKLY ATTACHES/DETACHES TO ANY PICATINNY RAIL
- + LIGHTWEIGHT AND DURABLE ANODIZED ALUMINUM CONSTRUCTION
- + AVAILABLE IN MATTE BLACK FINISH OR DESERT TAN
- + UP TO 18° DIRECTIONAL CANT LEFT OR RIGHT
- + UP TO 20° PAN LEFT OR RIGHT

The AR Bipods combine a quick attach system for securing to any picatinny rail with all the other outstanding features you have come to expect from Caldwell®. Built in systems for both pivot and cant movements give the shooter maximum range of alignment without having to reposition the bipod. The unique internal spring system is both low profile and quiet. The unique leg adjustment mechanism delivers fast and secure, no-wobble height positioning. Rubber feet ensure good grip on all surfaces. Lightweight and durable anodized aluminum construction. Choose from sitting or prone models.



# SHOOTING BIPODS

## 8.75"-12" PRONE

PRODUCT# 457855 • UPC# 661120397229

## 14"-30" SITTING

PRODUCT# 335235 • UPC# 661120352358

- + EASILY ATTACHABLE AND DETACHABLE FROM THE FRONT SWIVEL STUD
- + LIGHTWEIGHT ALUMINUM DESIGN FOR QUIET, WEATHERPROOF PERFORMANCE
- + BUILT-IN SWIVEL PAN FEATURE LEFT OR RIGHT 20 DEGREES COMBINED WITH AN 18 DEGREE BI-DIRECTIONAL CANT
- + STUD FOR SLING ATTACHMENT

Designed with all of the features necessary for steady, accurate shooting, regardless of the range or terrain. Now you have extreme motion ranging capability with our exclusive wide-pan and stock canting features that come standard with our bipod design. Two-models available for adapting to any shooting situation. Folds out-of-the-way when not in use.



# MAG SHIELD

PRODUCT# 300010 • UPC# 054118000452

- + AMBIDEXTROUS
- + 1/2" THICK ENERGY-ABSORBING PAD
- + APPROXIMATELY 20 CUBIC INCHES OF COVERAGE
- + SOFT LEATHER PROVIDES AMPLE FRICTION TO KEEP GUN LOCKED INTO THE SHIELD AND YOUR SHOULDER

The Magnum Recoil Shield is designed to provide unparalleled recoil protection while sighting in your rifle, bench rest shooting, or participating in many other shooting activities. The size and shape of the Magnum Recoil Shield creates the perfect combination of function and comfort. It can be worn on the left or right shoulder and attaches with an easily adjustable side closure for a secure fit. The leather on the front secures the gun in place, while the leather on the back of the shield provides a comfortable feel and prevents the shield from sliding around on your shoulder.



# MAG SHIELD PLUS

PRODUCT# 310010 • UPC# 054118002500

- + AMBIDEXTROUS
- + 1/2" THICK ENERGY-ABSORBING PAD
- + APPROXIMATELY 32 CUBIC INCHES OF COVERAGE
- + SOFT LEATHER PROVIDES AMPLE FRICTION TO KEEP GUN LOCKED INTO THE SHIELD AND YOUR SHOULDER

The Mag Plus Shield is designed to provide the same unparalleled recoil protection as the original Mag Shield but features a larger surface area. The heart shaped design expands the recoil absorption area, extending protection to the upper arm. This quality is especially valuable in those cases when the rifle or shotgun is not shouldered perfectly. The size and shape of the Mag Plus Shield creates the perfect combination of function and comfort. This time-tested design has become a favorite for shooters around the world.



# SUPER MAG SHIELD PLUS

PRODUCT# 330110 • UPC# 054118001558

- + AMBIDEXTROUS
- + 1" THICK ENERGY-ABSORBING PAD
- + APPROXIMATELY 40 CUBIC INCHES OF COVERAGE
- + SOFT LEATHER PROVIDES AMPLE FRICTION TO KEEP GUN LOCKED INTO THE SHIELD AND YOUR SHOULDER

The Super Mag Plus Shield is designed to provide the highest protection level of any of our shields. With maximum amount of absorbing protection, shooting even the biggest calibers like the 416 Rigby and the 500 Nitro Express. The comfortable leather cover conforms to the body while the energy-absorbing foam insert dramatically reduces felt recoil.



# FIELD SHIELD

PRODUCT# 350010 • UPC# 054118000537

- + AMBIDEXTROUS
- + 1/4" THICK ENERGY-ABSORBING PAD
- + APPROXIMATELY 37 CUBIC INCHES OF COVERAGE
- + SOFT LEATHER PROVIDES AMPLE FRICTION TO KEEP GUN LOCKED INTO THE SHIELD AND YOUR SHOULDER

Created with the field shooter in mind, the lightweight, foam recoil system is designed for quick and easy gun mounting in the field and provides valuable protection from recoil. It is ambidextrous and attaches with an easily adjustable hook and loop closure for a secure fit. Front and back leather faces secure the gun comfortably in place, eliminating any sliding. The shield's 1/4" thick energy-absorbing pad provides excellent protection from all shotguns.



# HIDDEN COMFORT RECOIL SHIELD

PRODUCT# 360000 • UPC# 054118003620

- + AMBIDEXTROUS
- + 1/4" THICK ENERGY-ABSORBING PAD
- + APPROXIMATELY 30 CUBIC INCHES OF COVERAGE
- + COMFORTABLE COTTON-BLEND COVER EASILY ATTACHES TO BRA STRAP WITH HOOK AND LOOP CLOSURES

Created with the field shooter in mind, the lightweight, foam recoil system is designed for quick and easy gun mounting in the field and provides valuable protection from recoil. It is ambidextrous and attaches with an easily adjustable hook and loop closure for a secure fit. Front and back leather faces secure the gun comfortably in place, eliminating any sliding. The shield's 1/4" thick energy-absorbing pad provides excellent protection from all shotguns.



# E-MAX<sup>®</sup> SHADOWS PRO

PRODUCT# 1136234 · UPC# 661120259961

- + LAB CERTIFIED 25DB NRR HEARING PROTECTION
- + BLUETOOTH<sup>®</sup> CONNECTIVITY FOR STREAMING MUSIC & TAKING CALLS
- + CHARGE LEVEL INDICATORS FOR MONITORING BATTERY LIFE FOR CASE & EAR BUDS
- + MULTIPLE SIZE TIPS FOR COMFORTABLE FIT & PERFECT SEAL

The E-MAX Shadows Pro are your favorite E-MAX Shadows with some new bells and whistles. The E-MAX Shadows Pro connect via Bluetooth to your device for up to 6 hours of music or phone calls. The redesigned pro version of the Shadows feature push button controls to make it easy to adjust ambient noise, change volume, answer phone calls, and control your voice assistant app like Siri. This product contains an optional magnetic lanyard and a rechargeable storage case that has an LED Battery Level Indicator for each ear bud so you know when your E-MAX Shadows Pro are fully charged and ready for the range. Like the E-MAX Shadows, these come with multiple size earplug options for a custom fit for anyone. The custom sized foam tips achieve a rating of 25dB NRR.



## Bluetooth<sup>®</sup>

"The Bluetooth<sup>®</sup> word mark and logos are registered trademarks owned by Bluetooth SIG, Inc. and any use of such marks by AOB Products Company is under license. Other trademarks and trade names are those of their respective owners."

patents: aob.com/patents

# E-MAX<sup>®</sup> SHADOWS

**BLACK**

PRODUCT# 1102673 · UPC# 661120075691

**FLAT DARK EARTH**

PRODUCT# 1134903 · UPC# 661120103608

- + BLUETOOTH<sup>®</sup> CONNECTIVITY FOR STREAMING MUSIC & TAKING CALLS
- + LAB CERTIFIED 23DB NRR HEARING PROTECTION
- + DUAL MICROPHONES FOR DIRECTIONAL CLARITY
- + MULTIPLE SIZE TIPS FOR CUSTOM FIT
- + RECHARGEABLE STORAGE CASE

The E-Max Shadows are Bluetooth, rechargeable electronic ear plugs designed to go where you go, play all your music, and keep your ears protected. High quality stereo sound is Bluetooth compatible with your mobile device and comes with a 23dB noise reduction rating. Dual microphones provide directional clarity and come equipped with easy to use touch volume controls. The charging case comes with an integrated lithium battery.



## Bluetooth<sup>®</sup>

"The Bluetooth<sup>®</sup> word mark and logos are registered trademarks owned by Bluetooth SIG, Inc. and any use of such marks by AOB Products Company is under license. Other trademarks and trade names are those of their respective owners."

patents: aob.com/patents

# E-MAX<sup>®</sup> POWER CORDS

PRODUCT# 1121933 · UPC# 661120081432

- + BLUETOOTH<sup>®</sup> CONNECTIVITY FOR STREAMING MUSIC & TAKING CALLS
- + LAB CERTIFIED 22DB NRR HEARING PROTECTION
- + 6 HOUR RUN TIME
- + MULTIPLE SIZE TIPS FOR CUSTOM FIT

The E-Max Power Cords are Bluetooth ear plugs that allow you to listen to your favorite music on your mobile device all while protecting your hearing on the range. Complete with high-quality stereo sound and a corded design that keeps them together, these plugs are rated with a 22dB noise reduction rating.



## Bluetooth<sup>®</sup>

"The Bluetooth<sup>®</sup> word mark and logos are registered trademarks owned by Bluetooth SIG, Inc. and any use of such marks by AOB Products Company is under license. Other trademarks and trade names are those of their respective owners."

# E-MAX<sup>®</sup> PRO

- + LAB CERTIFIED 23DB NRR HEARING PROTECTION
- + LOW-PROFILE DESIGN FOR UNINTERRUPTED CHEEK WELD - COMPACT FOLDING DESIGN
- + EASY TO USE PUSH BUTTON VOLUME CONTROLS
- + AUTO-SHUTOFF (4 HOURS WITHOUT TOUCHING CONTROLS)
- + RUNS ON 3 AAA BATTERIES (INCLUDED) OR CALDWELL'S LITHIUM-ION BATTERY PACK (SOLD SEPARATELY)

## YOUTH SIZES



**GRAY**  
PRODUCT# 1099602  
UPC# 661120417910



**FDE**  
PRODUCT# 1099603  
UPC# 661120417903



**AQUA**  
PRODUCT# 1101672  
UPC# 661120075745



**NEON BLUE**  
PRODUCT# 1103307  
UPC# 661120418702



**HOT CORAL**  
PRODUCT# 1108763  
UPC# 661120079293



**NEON GREEN**  
PRODUCT# 1103306  
UPC# 661120418696

# PASSIVE HEARING PROTECTION

- + LOW-PROFILE DESIGN FOR UNINTERRUPTED CHEEK WELD
- + 24DB NOISE REDUCTION RATING
- + COMFORT PADDED HEADBAND - SOFT COMFORTABLE EAR CUSHIONS
- + COMPACT FOLDING DESIGN

## YOUTH SIZES



**GRAY**  
PRODUCT# 1103305  
UPC# 661120418689



**NEON BLUE**  
PRODUCT# 1103308  
UPC# 661120418719



**HOT CORAL**  
PRODUCT# 1108764  
UPC# 661120079309



**NEON GREEN**  
PRODUCT# 1103309  
UPC# 661120418726

# E-MAX<sup>®</sup> LOW PROFILE

**GREEN**

PRODUCT# 487557 • UPC# 661120875574

**PINK**

PRODUCT# 487111 • UPC# 661120871118

**MOSSY OAK BREAK-UP**

PRODUCT# 487200 • UPC# 661120872009

- + 23DB NOISE REDUCTION RATING
- + ADJUSTABLE VOLUME CONTROL
- + 3.5MM AUDIO INPUT JACK
- + DUAL MICROPHONES INSTANTLY SHUT OFF TO PROTECT THE SHOOTER'S HEARING

The Low-Profile E-Max<sup>®</sup> hearing protection combines great circuitry with a low profile earcup that's ideal for shotgun shooters and action shooters. The E-Max<sup>®</sup> amplifies sounds below 85 decibels, which amplifies normal communication, range commands, and environmental sounds. Two microphones – one in each cup – give the user true stereo sound and allow the user to identify the directional source of a sound. Runs on 2 AAA batteries (not included).



## E-MAX®

PRODUCT# 497700 • UPC# 661120977001

- + 25DB NOISE REDUCTION RATING
- + DUAL MICROPHONES INSTANTLY SHUT OFF TO PROTECT THE SHOOTER'S HEARING
- + PADDED HEADBAND FOR MAXIMUM COMFORT
- + TRUE STEREO AMPLIFICATION DELIVERS MAXIMUM VOLUME AND CLARITY

The Caldwell E-Max hearing protection combines great circuitry with a standard earcup for better protection. The two microphones in the E-Max amplify sounds below 85 decibels, which amplifies normal communication, range commands, and environmental sounds. Above 85 decibels, the microphones shut off to protect the shooter's hearing. Ear cup width is 1.75 inches and two AAA batteries are required (not included). Enabled with one stereo microphone in each cup, the user can localize sound from all directions. 25dB Noise Reduction Rating.



## E-MAX® BTH

PRODUCT# 487605 • UPC# 661120876052

- + 21DB NOISE REDUCTION RATING
- + ADJUSTABLE VOLUME CONTROL
- + DUAL MICROPHONES INSTANTLY SHUT OFF TO PROTECT THE SHOOTER'S HEARING
- + TRUE STEREO AMPLIFICATION DELIVERS MAXIMUM VOLUME AND CLARITY

The E-Max® Behind-the-Head hearing protection combines great circuitry with a low profile ear cup that's ideal for shotgun shooters and action shooters. The E-Max® amplify sounds up to 20dB, controlled by the volume dial on the right ear cup. This is beneficial for normal communication, range commands, and environmental sounds. With sounds above 85 decibels, the speakers shut off for a split second to protect the shooters hearing. Two microphones, one in each cup, give the user true stereo function and help the user to localize sound. 21dB Noise Reduction Rating.



## RANGE PLUGS (10-PACK)

PRODUCT# 568231 • UPC# 661120682318

- + 31DB NRR
- + TAPERED DESIGN MAKES THE PLUGS EASY TO INSERT
- + POLYURETHANE FOAM MAKES THE PLUGS COMFORTABLE TO WEAR
- + CORD AND CLIP MAKE IT EXTREMELY EASY TO KEEP TRACK OF

Never lose your earplugs again with Caldwell Range Plugs featuring integrated cord and clip. Caldwell designed these Range Plugs to have tapered shape, made of polyurethane foam to make them easy to insert and comfortable for hours of use. The cord can be used in conjunction with the provided clip to snap on the back of your hat or the collar of your shirt so you always know where your ear plugs are. 31dB Noise Reduction Rating.





# PRO RANGE SHOOTING GLASSES

PRODUCT# 320040 • UPC# 661120200406

- + ADJUSTABLE NOSTRIL AND ANCHOR POINTS FITTING TO A PICATINNY RAIL
- + BUSHY BROW BRUSH FOR RANGE MADE FROM ALUMINUM CONSTRUCTION
- + IMPACT RESISTANT FASTENERS ENSURE A SECURE ATTACHMENT

The Caldwell Pro Range Glasses feature a stylish wrap-around design and are a great choice for all shooters. They feature an adjustable nose piece and temples for all day comfort. The scratch resistant lens meets ANSI Z87.1 standards and offers 99.9% UV protection.



# E-MAX® LOW PROFILE MUFFS & SHOOTING GLASSES COMBO

PRODUCT# 487309 • UPC# 661120873099

- + 25DB NOISE REDUCTION RATING
- + DUAL MICROPHONES INSTANTLY SHUT OFF TO PROTECT THE SHOOTER'S HEARING
- + PADDED HEADBAND FOR MAXIMUM COMFORT
- + TRUE STEREO AMPLIFICATION DELIVERS MAXIMUM VOLUME AND CLARITY

The Caldwell E-Max hearing protection combines great circuitry with a standard earcup for better protection. The two microphones in the E-Max amplify sounds below 85 decibels, which amplifies normal communication, range commands, and environmental sounds. Above 85 decibels, the microphones shut off to protect the shooter's hearing. Ear cup width is 1.75 inches and two AAA batteries are required (not included). Enabled with one stereo microphone in each cup, the user can localize sound from all directions. 25dB Noise Reduction Rating.

The Caldwell Pro Range Glasses feature a stylish wrap-around design and are a great choice for all shooters. They feature an adjustable nose piece and temples for all day comfort. The scratch resistant lens meets ANSI Z87.1 standards and offers 99.9% UV protection.



# EYES & EARS BELT CLIP

PRODUCT# 417600 • UPC# 661120176008

- + CONVENIENTLY HOLDS YOUR HEARING PROTECTION, SAFETY GLASSES & KEYS
- + FITS UP TO A 2 1/4" WIDE BELT
- + MATERIAL BENDS BUT WON'T BREAK

The Caldwell Eyes and Ears Belt Clip offers shooters a secure, convenient location to store both eye and ear protection when not in use. Ideal for at the range or in the field, the Eyes and Ears Belt Clip puts an end to the old question of where did those glasses or ear muffs go? Constructed of durable, flexible polymer, the Eyes and Ears Belt Clip will survive years of use. Accepts belts up to 2 1/4 inches wide, and hearing protection with bands up to 2 inches wide.



# ULTIMATE SHOOTING GLOVES

## SMALL/MEDIUM

PRODUCT# 1071004 • UPC# 661120512936

## LARGE/X-LARGE

PRODUCT# 1071005 • UPC# 661120512943

- + CUSTOMIZED PADDING LAYOUT ALLOWS FULL RANGE OF MOVEMENT
- + ELASTIC BACKING AND FINGERS PROVIDES A CUSTOM GRIP FOR EXTREME DEXTERITY
- + LEATHER REINFORCEMENT PATCH PROTECTS AGAINST "SLIDE BITE"
- + RUBBERIZED PALM PROVIDES EXTREME GRIP

Caldwell's Ultimate Shooting Gloves are the ideal accessory for your range bag. These lightweight gloves are built to protect your hands from the elements. Their breathable material prevents your hands from overheating while a section is reinforced with leather to avoid slide bite. The elastic backing provides a custom grip for extreme dexterity to you can easily load magazines.



# TAC OPS® BELLY BAND HOLSTER

## STANDARD

PRODUCT# 1082698 • UPC# 661120412540

## X-LARGE

PRODUCT# 1092405 • UPC# 661120415503

- + HIGH QUALITY, MOISTURE-WICKING MATERIAL FOR MAXIMUM BREATHABILITY
- + TWO ELASTIC POCKETS THAT CAN BE USED TO APPENDIX CARRY WITH LEFT OR RIGHT HAND DRAW
- + SLIDE PROTECTION TAB KEEPS FIREARMS AWAY FROM THE SKIN
- + ELASTIC POCKETS CAN DOUBLE AS A CELL PHONE HOLDER, MAGAZINE HOLDER OR FLASHLIGHT HOLDER

Carry comfortably with the Caldwell Tac Ops Belly Band Holster. With high quality, moisture-wicking material this holster is perfect for every day carry, even in warmer weather. The slide protection tab keeps firearms away from the skin to prevent pinching or rubbing while in use. This tactical handgun holster is also machine washable making cleaning a breeze. Standard size fits waists up to 40". X-Large size fits waists up to 52".



# UNIVERSAL BRASS CATCHER S.A.

PRODUCT# 110038 • UPC# 661120000457

- + SWING-OPEN DESIGN ALLOWS FOR CONVENIENT CHAMBER ACCESS
- + UNIVERSAL DOUBLE HOOK & LOOP ATTACHMENT FOR USE ON BOLT-ACTION AND SEMI-AUTOMATIC RIFLES
- + INTERNAL CAGE DESIGN MAINTAINS BAG SHAPE
- + 100 ROUND CAPACITY (.223) WITH A ZIPPERED BOTTOM FOR EASY BRASS REMOVAL

The Caldwell Universal Brass Catcher is the perfect tool for any re-loader or conscious shooter. This expended brass catcher conveniently fits onto bolt-action and semi-automatic rifles to allow you to focus on shooting, rather than worrying about where your brass is landing. When the bag is full (100 rounds of .223) simply use the zipper on the bottom of the bag to empty the casings into your desired container and keep shooting.



# BRASS TRAP

PRODUCT# 122560 • UPC# 661120225607

- + USE ON BENCHTOP OR ATTACH TO ANY TRIPOD WITH A 1/4-20 MALE THREADED STUD (TRIPOD NOT INCLUDED)
- + FOLDS UP EASILY FOR COMPACT STORAGE
- + HEAT RESISTANT MESH RESISTS MELTING
- + INCLUDED STORAGE BAG

Are you tired of spending as much time sifting through grass looking for brass as you do shooting at the range? Look no more with the Caldwell Brass Trap. It is specifically designed to catch the brass in most shooting environments with any gun. The Brass Trap quickly assembles to be set on a bench and catch all of your rifle brass or it can be mounted on tripod to catch all of your pistol brass. When you are done shooting simply unzip the zipper for quick brass removal and break it down to store in your range bag. Spend more time shooting and less time looking for brass with the Caldwell Brass Trap.



Storage Bag Included

# PIC RAIL BRASS CATCHER

PRODUCT# 530143 • UPC# 661120301431

- + MOUNTS TO ANY AR-15 RIFLE WITH A FLAT TOP OR PICATINNY RAIL HAND GUARD
- + COMPATIBLE WITH MOST AR-10/LR-308 MODELS AS WELL
- + CONVENIENT ZIPPER AT BOTTOM OF MESH BAG MAKES EMPTYING SIMPLE
- + HEAT RESISTANT MESH WILL NOT MELT
- + LARGE 100 ROUND CAPACITY (.223)

The Caldwell® AR-15 Pic Rail Brass Catcher mounts to any Pic Rail with its quick detach anodized aluminum clamp and captures the ejected brass during firing. The clamp and wire frame are fully adjustable to work with a wide variety of rail/optic configurations and allow brass to enter bag without any disruption to bolt function or cycling. The quick detent locking attachment feature allows for quick installation and removal of the brass catcher; which allows for quick checking or clearing of the rifle chamber. Convenient zipper at bottom of mesh bag makes emptying simple.



# PIC RAIL SPARE MOUNT

PRODUCT# 123904 • UPC# 661120239048

- + WORKS WITH THE CALDWELL PIC RAIL BRASS CATCHER
- + USE EXTRA PIC RAIL MOUNTS TO MAKE SWITCHING BETWEEN RIFLES AN EASY PROCESS
- + MOUNTS TO ANY EXTENDABLE MAGAZINE RIFLE WITH A FLAT TOP OR PICATINNY RAIL HAND GUARD

Put extra pic rail mounts on other guns. That way you can switch your Pic Rail Brass Catcher between rifles quickly and easily.

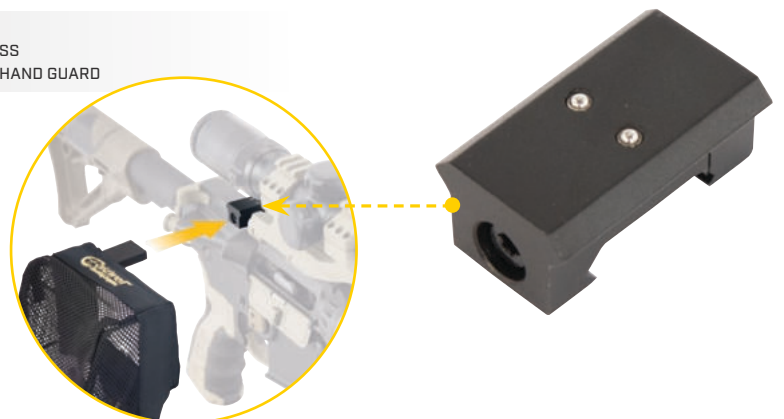

# AR-15 BRASS CATCHER

PRODUCT# 122231 • UPC# 661120222316

- + QUICKLY ATTACHES TO ANY AR-15 USING HOOK AND LOOP WEBBING
- + HOLDS APPROXIMATELY 30 ROUNDS OF SPENT BRASS (.223)
- + WIRE FRAME IS ADJUSTABLE TO FORM IT TO MOST ANY RIFLE
- + HEAT RESISTANT MESH WILL NOT MELT
- + ZIPPER FOR EASY EMPTYING

Tired of picking up brass from your AR? The AR-15 Brass Catcher attaches to the forearm of any AR with hook and loop webbing and captures the ejected brass. It prevents brass from being scattered around your shooting area, and works great in preventing hot brass from landing on shooter or other people next to the shooter. A wire frame holds fabric in correct shape and allows brass to enter bag without disruption to bolt function or interrupting cycling.



# MAG CHARGER® AR-15

PRODUCT# 397488 • UPC# 661120222316

- + LOAD AR MAGAZINES IN JUST SECONDS
- + ACCEPTS 50 ROUNDS OF .223, 5.56, .204 OR 300 AAC BLACKOUT LOADED AMMO
- + INSTANT TRANSFER SYSTEM FROM AMMO BOX DIRECTLY TO MAG CHARGER®
- + LOADS 5 ROUNDS PER "STROKE" WITH AUTO ADVANCE

Simply put, the Caldwell AR Mag Charger revolutionizes the way ammo is handled and loaded into AR-15 magazines. It is designed to accept 50 rounds directly from any common 50 round ammo manufacturer box or from aftermarket 50 round plastic storage boxes. Simply align bullet tips and dump a box of ammo into the Mag Charger. The ammo is automatically aligned without touching a single round.



patents: aob.com/patents

# MAG CHARGER® TAC 30

PRODUCT# 397493 • UPC# 661120974932

- + LOAD AR MAGAZINES IN JUST SECONDS
- + ACCEPTS 30 ROUNDS OF .223, 5.56 OR .204
- + TRANSFER DIRECTLY FROM A 20 ROUND BOX
- + LOADS 10 ROUNDS PER "STROKE" WITH AUTO ADVANCE

The Caldwell Mag Charger Tac-30 is designed to directly accept 20 live rounds from any common 20 round ammo manufacturer box and will also conveniently accept up to three 10 round stripper clips. The entire process of filling the Mag Charger Tac-30 with ammo and loading all 20-30 rounds into a magazine takes less than 10 seconds! Spend more time shooting and less time reloading with the Caldwell MagCharger Tac-30!



patents: aob.com/patents

# MAG CHARGER® AMMO BOXES

**.223/204 AMMO BOXES (5-PACK)**

PRODUCT# 397623 • UPC# 661120976233

**7.62X39 AMMO BOXES (5-PACK)**

PRODUCT# 397480 • UPC# 661120974802

- + OPTIMIZED TO DROP AMMO INTO THE CALDWELL MAG CHARGER
- + LID IS REMOVABLE AND NESTS WITH THE BOTTOM CAVITY
- + DURABLE POLYMER DESIGNED TO BE EXTREMELY TOUGH
- + GREAT FOR LONG TERM STORAGE

The Caldwell AR-15 and AK Mag Charger Ammo Boxes are optimized to drop ammo into the Caldwell Mag Charger. The lid is removable and nests with the bottom cavity. The durable polymer is designed to be extremely tough and is great for long term storage.



# MAG CHARGER® UNIVERSAL PISTOL LOADER

PRODUCT# 110002 • UPC# 661120100027

- + UNIVERSAL DESIGN WORKS ON MOST MAGAZINES
- + WORKS WITH BOTH SINGLE-STACK AND DOUBLE-STACK MAGAZINES
- + LOADS 9MM, 10MM, .357 SIG, .40 S&W AND .45 CAL AMMO
- + SIMPLE TO USE - JUST DROP IN A ROUND AND SQUEEZE THE LEVER

The Caldwell Mag Charger Universal Pistol Loader is designed to work with almost all pistol magazines. The Universal Pistol Loader works with both single-stack and double-stack magazines and loads 9mm, 10mm, .380, .357 Sig, .40 S&W and .45 ACP. This magazine loader is simple to use, just drop in a round and squeeze the lever. The adjustable side shims align magazines of any width for optimal use, and are labeled with numbers for quick adjustment.



patents: aob.com/patents

# 22LR ROTARY MAG CHARGER®

PRODUCT# 1099117 • UPC# 661120417521

- + HOLDS UP TO 100 ROUNDS OF 22LR AMMO IN THE HOPPER
- + DURABLE POLYCARBONATE CONSTRUCTION
- + FAST AND EASY AMMO LOADING LEAVES MORE TIME FOR SHOOTING
- + HOPPER AUTOMATICALLY ORIENTS AMMO CORRECTLY

The 22LR Rotary Mag Charger revolutionizes the way you load your 10/22 rotary magazines. With this innovative design, you can take loose rounds of ammunition and load your magazine within seconds. The Mag Charger automatically aligns each round. All you do is insert the magazine and twist the plunger loading the ammo until fully loaded.



patents: aob.com/patents

# 22LR AR-15 22 MAG CHARGER®

PRODUCT# 1097887 • UPC# 661120417873

- + COMPATIBLE WITH ALL POPULAR AR-15 22LR MAGAZINES WITH LOAD ASSIST MAG
- + DURABLE POLYCARBONATE CONSTRUCTION
- + AMMO HOPPER AUTOMATICALLY ORIENTS ROUNDS FOR LOADING
- + EASY HANDHELD OPERATION

The 22LR AR-15 22 Mag Charger revolutionizes the way you load your AR-15 magazines. With this innovative design, you can take loose rounds of ammunition and load your magazine within seconds. The Mag Charger automatically aligns each round. All you need to do is insert the magazine and pull the magazine follower down loading the ammo into the magazine.



patents: aob.com/patents

# FAST CASE GUN COVER

PRODUCT# 110039 • UPC# 661120000464

- + DURABLE BALLISTIC FABRIC WITHSTANDS ABRASION AND TOUGH USE
- + FITS RIFLES OR SHOTGUNS FROM 40"-54" IN LENGTH
- + FOLDS UP INTO A COMPACT SIZE AND FITS IN A PACK
- + PVC LINED FABRIC MAKES CASE WATER RESISTANT

The Caldwell Fast Case Gun Cover protects firearms from all that Mother Nature can throw at them. Durable ballistic fabric stands up to thorns, sticker bushes, or any other abrasive surfaces. The PVC lined fabric provides a water resistance to the firearm in rain and snow. The large bottom opening allows the user to keep the firearm covered but still allows them to carry it with a standard sling. The Caldwell Fast Case is very easy to put on and fast to take off when the shot matters most.



# AR MODULAR DUAL POINT SLING KIT

PRODUCT# 156216 • UPC# 661120905011

- + CAN BE USED WITH THE SIDE-RELEASE BUCKLE OR THE SPRING-LOADED CARABINER
- + USE AS A SINGLE POINT SLING OR STANDARD DUAL POINT SLING
- + QUICK DITCH BUCKLE ALLOWS YOU TO UNSLING YOUR AR WITHOUT REMOVING THE SLING
- + AMBIDEXTROUS RECEIVER END PLATE INCLUDED

The AR Modular Dual Point Sling is great for use as a single point sling or detach second spring loaded carabiner and set up as a standard dual point sling. Features premium spring loaded quick detach carabiners and steel ambidextrous receiver plate included. With 2 Quick Ditch buckle options, either use the side release buckle to remove the gun from the sling or use the spring-loaded carabiner to remove the sling from your body.



# AR RECEIVER END PLATE SLING MOUNT

PRODUCT# 390501 • UPC# 661120905011

- + AMBIDEXTROUS FOR ALL SHOOTERS
- + ACCEPTS SNAP HOOK STYLE ATTACHMENTS
- + ONE SOLID STEEL PLATE
- + MADE IN THE USA

The Caldwell AR Receiver End Plate Sling Mount offers an ambidextrous sling mount solution for all AR platform firearms. It is constructed from solid steel and accepts snap hook style attachments



# SINGLE POINT TACTICAL SLING KIT

PRODUCT# 156215 • UPC# 661120562153

- + AR RECEIVER END PLATE INCLUDED
- + ADJUSTABLE NYLON STRAP WITH QUICK RELEASE BUCKLE
- + ALLOWS SAFE AND CONVENIENT MUZZLE DOWN CARRY POSITION
- + QUICK DETACH CARABINER WITH SAFETY SLEEVE

Single attachment point slings have quickly become the standard for field carry of AR platform guns as well as many other firearms. This heavy duty bungee sling easily attaches to the gun with its steel carabiner clip and the nylon strap with quick release buckle adjusts for length. The gun is held in a safe and convenient muzzle down ready position.



# AR-15 MAG COUPLER

PRODUCT# 390504 • UPC# 661120905042

- + CONTAINS 2 COUPLERS TO COUPLE A TOTAL OF 4 MAGAZINES
- + CONTAINS 2 DUST COVERS TO KEEP DUST OUT AND PROTECT BULLET TIPS
- + SAME BASIC PROFILE AS A 30 ROUND MAG TO FIT IN EXISTING MAG POUCHES
- + COUPLES 2 MIL-SPEC STYLE 10 ROUND AR MAGS TOGETHER

The Mag Couplers are made out of high strength polymer to easily couple 2 Mil-Spec Style 10 round AR-15 magazines together and not add weight. The coupling of magazines brings your capacity up to 20 rounds for faster reloads when seconds matter. The coupler is a 2 piece design that is bolted together to be extremely rigid without permanently modifying your magazines. The couplers hold the 2 magazines end to end to maintain the overall shape of a 30 round magazine to fit in all of your existing gun cases, mag pouches, etc.



# MAX GRIP SLINGS

**BLACK**

PRODUCT# 156219 • UPC# 661120562191

**FLAT DARK EARTH**

PRODUCT# 156214 • UPC# 661120562146

- + MAX GRIP OVERMOLDED DESIGN KEEPS FIREARMS SECURELY IN PLACE WHILE HIKING
- + 2.75" STRAP TO SPREAD THE WEIGHT OF THE FIREARM
- + INCLUDES QUICK DETACH METAL SLING SWIVELS
- + ADJUSTS FROM 20" TO 41" IN LENGTH

The Max Grip Sling's ergonomic shape is designed to spread the weight of the firearm for a comfortable carry. The over molded design of the material grips your shoulder so the firearm stays put no matter how strenuous your hike is. The sling is completely sealed to be scent free and not take in any moisture as you hunt through all of the elements. If you want a sling that is going to stay put and be comfortable to carry all day, the Caldwell Max Grip is the sling for you!



# MAX GRIP SLIM SLINGS

**BLACK**

PRODUCT# 1131995 • UPC# 661120103592

**FLAT DARK EARTH**

PRODUCT# 1131996 • UPC# 661120103691

- + MAX GRIP OVERMOLDED DESIGN KEEPS FIREARMS SECURELY IN PLACE WHILE HIKING
- + 1.5" STRAP SPREADS THE WEIGHT OF THE FIREARM WHILE STILL ALLOWING TO FREELY MOVE ARMS
- + INCLUDES QUICK DETACH METAL SLING SWIVELS
- + ADJUSTS FROM 20" TO 41" IN LENGTH

The Max Grip Slim Sling is adjustable from 20" to 41" for full comfort out on the range or on the trails. The non-slip ergonomic design is sure to keep your firearm secure while you're out in the wilderness. With quick detach metal sling swivels, the Max Grip Slim Sling is the easiest and quickest way to keep your firearm secure.



# WIND WIZARD II™

PRODUCT# 102579 • UPC# 661120025795

- + WIND SPEED MEASURES IN MPH, FT./MIN, KM/H, M/S OR KNOTS
- + TEMPERATURES DISPLAY IN CELSIUS AND FAHRENHEIT
- + WIND CHILL DISPLAY
- + LCD BACKLIGHT WITH AUTO POWER OFF

The Wind Wizard II has been redesigned to be the best value wind meter on the market and an ideal tool for indicating wind speed. Knowing wind speed gives the shooter the ability to judge shot placement in varying wind conditions. Both compact and portable, this wind meter reads wind and temperature in various units of measure. The non-slip rubber sleeve protects the unit and ensures it's easy to grip even with gloved hands. Operates on one CR2032 battery (included).





# CLAY LAUNCHERS

## SINGLE THROWER

PRODUCT# 505501 • UPC# 661120055013

## DOUBLE THROWER

PRODUCT# 505502 • UPC# 661120055020

- + PORTABLE AND AFFORDABLE HANDHELD CLAY TARGET LAUNCHER
- + WORKS WITH ALL STANDARD SIZE CLAY TARGETS
- + LAUNCHES RIGHT OR LEFT HANDED
- + DOUBLES THROWER FEATURES 2 SINGLE THROWERS MOUNTED TO AN ADAPTER HANDLE

The Clay Launchers are designed to provide hours of shooting entertainment. The one-piece design is simple to use and makes it easy for anyone to throw clay birds. Simply insert the clay target and fling it to send the target sailing. Durable molded plastic construction.



# BRASS RETRIEVER

PRODUCT# 125789 • UPC# 661120257899

- + DESIGNED TO MAKE PICKING UP BRASS EXTREMELY EASY
- + WORKS ANYWHERE, EVEN ON GRASS AND GRAVEL
- + TELESCOPING HANDLE TO CUSTOMIZE LENGTH
- + COMES WITH A ROLL CAGE SEPARATOR THAT ALLOWS QUICK BRASS DUMPING

Spend less time bending over and picking up brass at the range and more time shooting. The Brass Retriever picks up brass saving your back and time. Now picking up spent brass is as easy as pushing a mop. The Brass Retriever can pick up rifle and pistol brass quickly and efficiently. The Brass Retriever works any where, even on grass and gravel. The retriever comes complete with a roll cage separator that allows you to dump the collected brass into a bucket quickly. It is collapsible as well, making it convenient to transport to and from the range. Expands from 28" up to 57" tall.



# AR500 STEEL TARGETS

- + 3/8" THICK AR500 STEEL
- + RATED UP TO 3,000 FPS IMPACT VELOCITY
- + RATED UP TO 3,500 FT LBS IMPACT ENERGY

Caldwell's bright, easy-to-see targets come in all shapes and sizes for competition, training, and recreational use. Made of AR500 hardened steel, these targets can withstand thousands of rounds. Rated up to a 3,000 fps impact velocity and a 3,500 ft-lb impact energy, these targets come in seven various sizes with three hanging solutions.

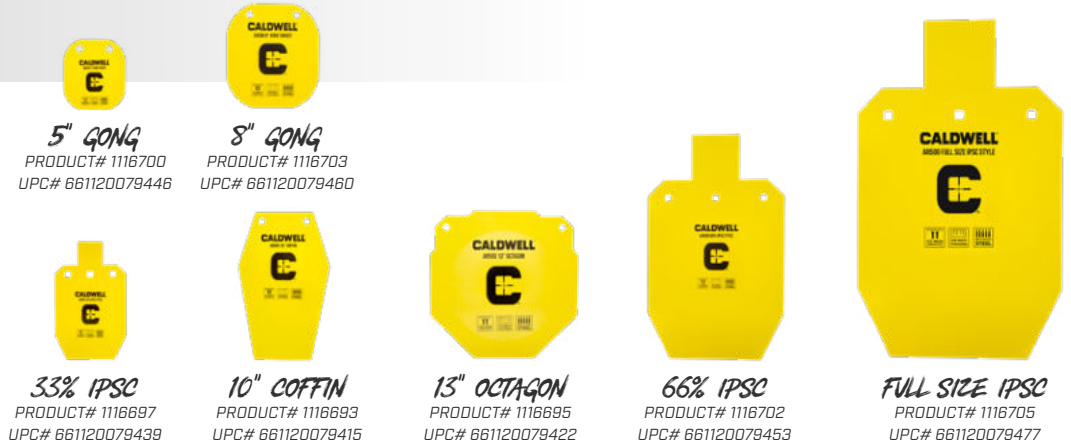

**5" GONG**

PRODUCT# 1116700  
UPC# 661120079446

**8" GONG**

PRODUCT# 1116703  
UPC# 661120079460

**33% IPSC**

PRODUCT# 1116697  
UPC# 661120079439

**10" COFFIN**

PRODUCT# 1116693  
UPC# 661120079415

**13" OCTAGON**

PRODUCT# 1116695  
UPC# 661120079422

**66% IPSC**

PRODUCT# 1116702  
UPC# 661120079453

**FULL SIZE IPSC**

PRODUCT# 1116705  
UPC# 661120079477

## PORTABLE RANGE KIT WITH 8" AR500 TARGET

PRODUCT# 1140016 • UPC# 661120259985

- + KIT COMES READY TO USE WITH STAND, STRAPS & 8" AR500 STEEL TARGET
- + POWDER COATED STEEL STAND BREAKS DOWN EASILY FOR PORTABILITY
- + HEAVY DUTY XL RUBBER STRAPS ACCOMMODATE DIFFERENT TARGET SIZES
- + PEACE OF MIND WITH LIFETIME WARRANTY ON AR500 TARGET

The Portable Range Kit with 8" AR500 Target combines the Caldwell AR500 Steel with the classic setup of the Caldwell Gong Target system. This set includes everything you need for a great day at the range - an 8" AR500 Steel Target that will withstand thousands of rounds, a collapsible steel stand for easy transport, and our XL Strap Hangers to hold up your target.



## PORTABLE TARGET STAND WITH STRAPS

PRODUCT# 1136057 • UPC# 661120259947

- + POWDER COATED STEEL STAND BREAKS DOWN EASILY FOR PORTABILITY
- + INCLUDED HEAVY DUTY XL RUBBER STRAPS ACCOMMODATE DIFFERENT TARGET SIZES

The Caldwell Portable Target Stand with Straps combines the durable XL Target Straps and collapsible steel stand to support all your favorite Caldwell AR500 Steel targets. The XL Target Straps are built to withstand repeated direct bullet impact and the stand easily collapses and stores compactly for easy transport to and from the range.



\*Target Not Included

## STRAP PLATE HANGER SET

PRODUCT# 1102671 • UPC# 661120075721

- + 12" LONG STRAPS
- + HIGH STRENGTH REINFORCED RUBBER CONSTRUCTION WITHSTANDS MULTIPLE BULLET IMPACTS
- + MOUNTING HARDWARE INCLUDED

The Caldwell Strap Plate Hanger Set is a perfect fit piece for hanging your Caldwell Steel Target. The Strap Plate Hanger is extremely easy to use and has a high-quality construction. To use the Strap Plate Hanger Set simply secure the straps to your favorite stand using the high-quality steel screws. Next, attach the Strap Plate Hanger to your favorite Caldwell Steel Target and you're all set!



# XL TARGET STRAPS

PRODUCT# 1136058 • UPC# 661120259954

- + 21" LONG STRAPS
- + MULTIPLE MOUNTING HEIGHT OPTIONS
- + HIGH STRENGTH REINFORCED RUBBER CONSTRUCTION WITHSTANDS MULTIPLE BULLET IMPACTS
- + MOUNTING HARDWARE INCLUDED

Caldwell XL Target Straps are made of durable nylon-enforced rubber that are able to withstand plenty of direct bullet impacts. Designed to support all of Caldwell's AR500 steel targets, these straps are also adjustable for precise height adjustment.



# AR500 STEEL PLATE HANGERS

## T-POST PLATE HANGER

PRODUCT# 1102669 • UPC# 661120075707

## 2X4 PLATE HANGER

PRODUCT# 1102670 • UPC# 661120075714

- + STEEL ACCESSORY FOR HANGING AR500 STEEL ON T-POST STANDS.
- + STEEL ACCESSORY FOR HANGING AR500 STEEL ON 2X4 STANDS.
- + CALDWELL AR500 STEEL ON ANY 2X4 POST YOU'RE USING ON THE RANGE.
- + HARDWARE INCLUDED

Steel plate hanger accessory that enables you to hang your favorite Caldwell AR500 steel on any T-post you're using on the range. Easily attaches to top of T-post with included hardware for hanging any of our Caldwell AR500 steel targets.

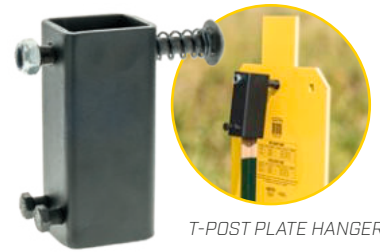

T-POST PLATE HANGER



2x4 PLATE HANGER

# AR500 AUTO RESET TARGETS

## AR500 33% PEPPER POPPER TARGET

PRODUCT# 1178560 • UPC# 661120265627

## AR500 PRAIRIE DOG TARGET

PRODUCT# 1178561 • UPC# 661120265634

- + HEAVY-DUTY 3/8" AR500 STEEL RATED FOR CENTERFIRE RIFLE USE
- + AUTOMATIC SPRING RESET ELIMINATES NEED TO GO DOWN RANGE & ALLOWS FOR INSTANT FEEDBACK
- + 7" ELEVATED STAND PROVIDES QUICK & EASY SETUP
- + PEACE OF MIND WITH LIFETIME WARRANTY ON AR500 TARGET

Add some fun interactive targets to your range with these Caldwell AR500 Auto Resetting Targets. Constructed using AR500, the finest rifle rated target steel available on the market. Each target includes a free-standing frame, popper, or prairie dog shape AR500 target and ground stakes. The base of the frame sits 7-inches off the ground. When the target is struck with a bullet it falls backward and is automatically reset with the integrated reset spring. For maximum life expectancy impact velocities of 3,000 fps or below and impact energies of 3,500 ft. lbs. or less are recommended.



# AR500 DEALER KITS

## HALF-SIZE DISPLAY KIT

PRODUCT# 1182824 • UPC# 661120651475

| Product# | Description              | Qty |
|----------|--------------------------|-----|
| 1102669  | T-POST PLATE HANGER      | 6   |
| 1102670  | 2X4 PLATE HANGER         | 6   |
| 1102671  | STRAP PLATE HANGER SET   | 6   |
| 1116693  | AR500 10" COFFIN         | 4   |
| 1116697  | AR500 33% IPSC TARGET    | 8   |
| 1116700  | AR500 5" CALDWELL C      | 12  |
| 1116702  | AR500 66% IPSC TARGET    | 2   |
| 1116703  | AR500 8" CALDWELL C      | 6   |
| 1134868  | 5" PLATE HOLDER          | 2   |
| 1134870  | 8" PLATE HOLDER          | 2   |
| 1134871  | 33% IPSC PLATE HOLDER    | 2   |
| 1134873  | PEG HANGER STEEL DISPLAY | 4   |
| 1181704  | SMALL AR500 DISPLAY      | 1   |

## FULL-SIZE DISPLAY KIT

PRODUCT# 1183600 • UPC# 661120651482

| Product# | Description                   | Qty |
|----------|-------------------------------|-----|
| 1102669  | T-POST PLATE HANGER           | 6   |
| 1102670  | 2X4 PLATE HANGER              | 6   |
| 1102671  | STRAP PLATE HANGER SET        | 6   |
| 1116693  | AR500 10" COFFIN              | 4   |
| 1116695  | AR500 13" OCTAGON             | 3   |
| 1116697  | AR500 33% IPSC TARGET         | 8   |
| 1116700  | AR500 5" CALDWELL C           | 18  |
| 1116702  | AR500 66% IPSC TARGET         | 2   |
| 1116703  | AR500 8" CALDWELL C           | 6   |
| 1116705  | AR500 FULL SIZE IPSC TARGET   | 1   |
| 1133881  | AR500 STEEL TARGET DISPLAY    | 1   |
| 1134868  | 5" PLATE HOLDER               | 4   |
| 1134870  | 8" PLATE HOLDER               | 3   |
| 1134871  | 33% IPSC PLATE HOLDER         | 2   |
| 1134872  | 13" PLATE HOLDER              | 1   |
| 1134873  | PEG HANGER STEEL DISPLAY      | 3   |
| 1134878  | PEG BOARD HANGER W/ SCAN HOOK | 12  |

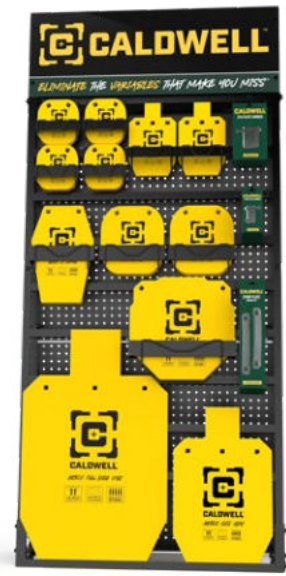

# RESETTING TARGETS

## AIRGUN TARGET

PRODUCT# 820585 • UPC# 661120205852

## .22 RIMFIRE TARGET

PRODUCT# 902365 • UPC# 661120023654

## HANDGUN TARGET

PRODUCT# 1071002 • UPC# 661120036548

- + EASILY PORTABLE
- + MADE OF HEAVY DUTY STEEL
- + SWINGING BOTTOM TARGETS
- + SHOOT TOP TARGET TO RESET BOTTOM ROW

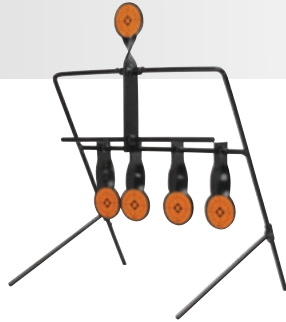

AIRGUN TARGET  
Dimensions: 11.5"W x 15"H x 1"D



.22 RIMFIRE TARGET  
Dimensions: 16.8"W x 22.5"H x 1.8"D



HANDGUN TARGET  
Dimensions: 12"W x 26.8"H x 1.8"D

# PLINK N' SWING ACTION TARGETS

## .22 RIMFIRE TRIPLE SPIN

PRODUCT# 147072 • UPC# 661120470724

## CENTERFIRE HANDGUN DOUBLE SPIN

PRODUCT# 133565 • UPC# 661120335658

- + SWINGERS AND FRAMES ARE MADE OF DURABLE STEEL FOR LONG LIFE
- + AUDIBLE FEEDBACK MAKES SHOOTING FUN FOR ALL AGES

Shooting is just plain fun when you can see and hear the impact of your bullets. Next time you go to the range, take the Caldwell® Plink N' Swing™ Targets to bring fun and fast action back to your shooting.

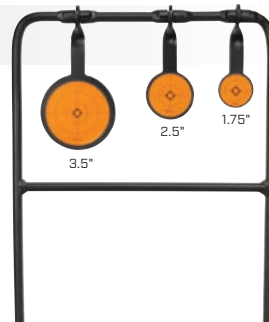

.22 RIMFIRE TRIPLE SPIN



CENTERFIRE HANDGUN DOUBLE SPIN

# MAGNUM TARGET CARRY BAG

PRODUCT# 894050 • UPC# 661120940500

- + INNER COMPARTMENTS FOR GONG, GROUND STAKES, CHAINS AND OTHER COMPONENTS
- + HEAVY DUTY CONSTRUCTION

The Magnum Target Carry Bag is designed to transport and store the Caldwell Portable Range Kit & AR500 Dual Spinner Target. Heavy duty construction and internal compartments keep target components protected and organized



# TARGET TURNER

PRODUCT# 1096103 • UPC# 661120417538

- + PRESENTS & HIDES TARGET FOR INTERACTIVE SHOOTING & TRAINING
- + VERSATILE DESIGN ACCEPTS ALL IDPA, IPSC, & NRA ACTION PISTOL CARDBOARD TARGETS
- + QUICKLY COLLAPSES INTO INCLUDED CARRY BAG FOR EASY TRANSPORT
- + 8 AA BATTERIES PROVIDE 8 HOURS OF RUNTIME FOR ALL DAY SHOOTING

The Target Turner sets the bar for a user-friendly interactive targeting system. The electronically operated Target Turner rotates 90°, back and forth, at user-adjustable speeds, making it the perfect interactive target. Featuring a low center of gravity and durable polymer and powder-coated steel construction, the Target Turner will give you years of reliable service, even in windy or wet conditions. Whether you're having fun in the backyard or you take your training seriously, the target turner will help refine your skills as a marksman.



\*TARGET NOT INCLUDED

patents: aob.com/patents

# ULTIMATE TARGET STAND

PRODUCT# 707055 • UPC# 661120070559

- + FRAME ARMS ARE CONSTRUCTED OF DURABLE STEEL ROD
- + FRAME COLLAPES FOR EASY TRANSPORT
- + BUILD-IN STORAGE HOLDS RANGE SUPPLIES
- + BACKER HOLDS UP TO (2) 16"X16" TARGETS

The Ultimate Target Stand features an oversized backer to hold multiple large targets and is constructed of an all-weather moisture resistant material. The large size makes sighting in easy, no more bullets missing the target. The frame arms are constructed of durable steel rod and hold the backer securely in place. Removable ground stabilizer adds support from wind during use and conveniently stows onto the feet.



## REPLACEMENT BACKER (2-PACK)

PRODUCT# 707100 • UPC# 661120071006

patents: aob.com/patents

# ULTRA PORTABLE TARGET STAND KIT

PRODUCT# 110005 • UPC# 661120100058

- + EXTRA LARGE BACKER CAN HOLD 12"X18" TARGETS
- + GREAT FOR SIGHTING IN OR PATTERNING
- + COLLAPSES FOR EASY TRANSPORT
- + INCLUDES 8 SILHOUETTE TARGETS AND 8 HIGH CONTRAST SIGHT-IN TARGETS

The Ultra Portable Target Stand Kit is your all-in-one target kit for the range! This compact set up includes a stand, backer, clamps and targets all in one package. The stand, clamps and backer are reusable and easy to assemble. This kit packs down to 12" x 18" for easy transport.

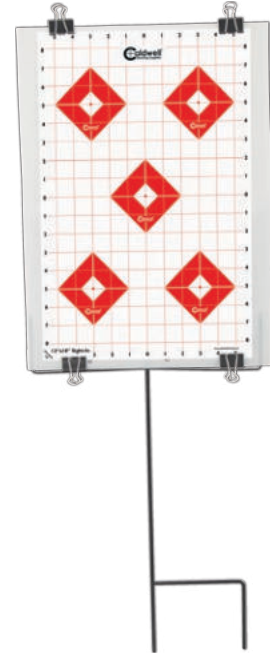

# DURAMAX™ SELF-HEALING TARGETS

5" BALL

PRODUCT# 897602 • UPC# 661120976028

5" SQUARE

PRODUCT# 897597 • UPC# 661120975977

- + MADE OF BALLISTIC POLYMER FOR MAXIMUM DURABILITY
- + TARGETS ARE SELF-HEALING SO YOU CAN SHOOT THEM THOUSANDS OF TIMES
- + RATED FOR PISTOLS OR RIFLES FROM .22LR ALL THE WAY UP TO 50 BMG
- + REACTIVE TARGETS; BOUNCES, ROLLS, SPINS OR FLIPS WHEN HIT

The Caldwell Duramax Self Healing Targets are made of ballistic polymer for maximum durability. The targets are self-healing and can be shot thousands of times. The Duramax Self Healing targets are rated for pistols or rifles from .22lr all the way up to 50 BMG. These reactive targets bring a whole new level of fun to the range. Watch them bounce, roll, spin, and flip when hit.

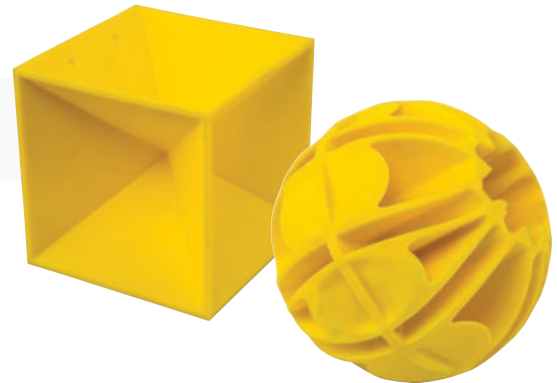



# FRANKFORD ARSENAL<sup>®</sup>



2023 NEW PRODUCTS

## X-10 PROGRESSIVE PRESS W/ CASE FEEDER

PRODUCT# 1178469 □ UPC# 661120654315

- 10-STATION DESIGN ALLOWS FOR VERSATILITY WITH DIE SETUP CONFIGURATIONS
- INCLUDED CASE FEEDER INCREASES ROUND OUTPUT PER HOUR
- INTEGRATED BALL BEARINGS THROUGHOUT FOR SMOOTH OPERATION AND REDUCED POWDER SPILLAGE
- ON-PRESS PRIMER POCKET SWAGING ALLOWS FOR SINGLE-PASS LOADING OF MILITARY BRASS
- POSITIVE RESET FEATURE ON POWDER MEASURE REDUCES THE CHANCE OF SQUIB LOADS
- INTEGRATED LED LIGHT IN TOOL HEAD FOR ILLUMINATED WORKSPACE

Designed by reloaders for reloaders, the Frankford Arsenal X-10 is a 10-station automatic indexing reloading press purpose built from the ground up to be the ultimate progressive reloading press. At its core, the X-10 features rigid steel construction, multiple ball bearings, and a proprietary 10-station, gear driven, rotating shell plate which all combine to virtually eliminate powder spillage and bullet tipping. The X-10 offers innovative improvements like dual de-capping stations to prevent primer drawback, in-line primer pocket swaging capability (for both small and large primers), and the ability to run powder check and case trimming dies.

The X-10 includes a case activated powder measure with a positive reset that reduces the chance of squib loads resulting from a sticking powder measure. When it's time to swap calibers, the X-10's innovative design allows the user the ability to quickly and easily swap out tool heads and shell plates to reload anything from 9mm to .308 length cartridges. The X-10 goes further and offers refined details like an included case feeder, roller handle, integrated LED light, and spring-loaded case locator buttons for added value and increased user experience. Add a X-10 Bullet Collator (sold separately) to make the X-10 the ultimate solution for progressive reloading.



patents: aob.com/patents

## X-10 SHELL PLATES

- FOR USE WITH THE X-10 PROGRESSIVE PRESS
- INTEGRATED BALL BEARINGS FOR SMOOTH INDEXING
- LASER ETCHED CALIBERS FOR EASY IDENTIFICATION
- INCLUDES HINGE-TOP STORAGE CASE

The X-10 Shell Plates make it quick and easy to change out calibers on the X-10 Progressive Press. Featuring integrated ball bearings for smooth indexing to reduce powder spillage. An included storage case keeps your shell plates clean and organized when not in use.



### SHELL PLATE #0

(9MM LUGER)

PRODUCT# 1136230 □ UPC# 661120260080

### SHELL PLATE #1

(.38 SPL, .357 MAG)

PRODUCT# 1135901 □ UPC# 661120260011

### SHELL PLATE #2

(.45 ACP, 6.5 CM, .308 WIN)

PRODUCT# 1135902 □ UPC# 661120260028

### SHELL PLATE #4

(.204 RUGER, .223 REM/5.56X45MM, .300 BLK)

PRODUCT# 1135903 □ UPC# 661120260035

### SHELL PLATE #11

(.44 SPL, .45 LC, .44 MAG, .454 CASULL)

PRODUCT# 1135904 □ UPC# 661120260042

### SHELL PLATE #19

(.40 S&W, 10MM AUTO, .38 SUPER)

PRODUCT# 1135905 □ UPC# 661120260059

patents: aob.com/patents

VISIT FRANKFORDARSENAL.COM FOR COMPLETE LIST OF COMPATIBLE CALIBERS.

## X-10 TOOL HEAD

PRODUCT# 1136231 □ UPC# 661120260097

- FOR USE WITH THE X-10 PROGRESSIVE PRESS
- NINE INTEGRATED 3.5MM MICRO-USB PORTS FOR SMART PRESS ACCESSORIES/DIES
- INTEGRATED LED LIGHT FOR ILLUMINATED WORKSPACE
- PURCHASE MULTIPLE TOOL HEADS FOR FAST CALIBER SWAPS

The X-10 Tool Head is a great option for anyone looking to change out calibers on the X-10 Progressive Press without losing die setups and settings. This replacement tool head features integrated LED lights and 3.5mm sensor ports.

patents: aob.com/patents





## X-10 POWDER MEASURE ASSEMBLY

PRODUCT# 1136232 □ UPC# 661120260103

- CASE ACTIVATED DESIGN ONLY OPERATES WHEN A CASE IS PRESENT
- INCLUDES THREE ACTIVATORS FOR SMALL AND LARGER RIFLE AND PISTOL CARTRIDGES
- PRECISION MICROMETER HAS ADJUSTABLE 2.5 - 50 GRAIN CHARGE RANGE
- POSITIVE RESET FEATURE ELIMINATES SQUIB LOADS

The X-10 Case Activated Powder Measure Assembly is compatible with the X-10 Progressive Press. Featuring a static-free aluminum body and a unique hopper shape to eliminate powder bridging and binding. The drum rides in ball bearings for ultra-smooth operation and the micro-adjustable dispense feature ensures maximum accuracy. The micrometer is capable of dispensing in increments of 2.5 - 50 grains. Assembly includes all of the required linkage and powder activators for easy plug and play operation on the X-10 Progressive Press.

patents: aob.com/patents



## SWAGE SUPPORT DIE

PRODUCT# 1198264 □ UPC# 66112065718

- FOR USE WITH X-10 PROGRESSIVE PRESS OR OTHER RELOADING SYSTEMS THAT UTILIZE INLINE SWAGING
- STANDARD 7/8"X14 THREADS
- LEAVE INSTALLED ON X-10 TOOL HEAD FOR FAST CALIBER SWAPS

The Swage Support Die is compatible with the Frankford Arsenal X-10 Progressive Press along with any other reloading system utilizing inline swaging. If running multiple X-10 Tool Heads, the user can leave this die fully setup on their Tool Head making it quick and easy to make caliber swaps.



## X-10 PISTOL BULLET COLLATOR

PRODUCT# 1135900 □ UPC# 661120263548

- DESIGNED FOR THE X-10 PROGRESSIVE PRESS TO INCREASE ROUND OUTPUT
- COMPATIBLE WITH 9MM LUGER, .38 SUPER, .40 S&W, & .45 ACP BY ADDING A CALIBER CONVERSION KIT

Increase your X-10 Progressive Press round output by adding the X-10 Pistol Bullet Collator. The collator assembly easily mounts to the X-10 Progressive Press with no additional modifications required. It features an automatic on/off switch and adjustable speed for reliable and consistent bullet feeding. Paired with one of the required Bullet Feed Caliber Conversion Kits (sold separately), the Pistol Bullet Collator feeds bullets for 9mm Luger, .38 Super, .40 S&W, & .45 ACP.

patents: aob.com/patents



## X-10 BULLET FEED CALIBER CONVERSION KITS

- KIT INCLUDES BULLET FEED DIE ASSEMBLY AND BULLET FEED PLATE
- INTEGRATES SEAMLESSLY INTO THE X-10 TOOL HEAD
- FEEDS AND SEATS BULLETS IN THE SAME STATION
- MICROMETER FOR ADJUSTABLE SEATING DEPTH (0.001") FOR FINE-TUNING BULLET SEATING

Caliber conversion kits include everything needed to connect the X-10 Bullet Feeder Collator (sold separately) to the X-10 Progressive Reloading Press. Kits include a caliber-specific bullet collator plate, bullet feed and shuttle assembly, and a micrometer adjustable seating die. The bullet feed system is integrated seamlessly into the X-10 Tool Head to feed and seat bullets in the same station.



### 9MM LUGER KIT

PRODUCT# 1194188 □ UPC# 661120746935

### .40 S&W KIT

PRODUCT# 1194190 □ UPC# 661120746959

### .38 SUPER KIT

PRODUCT# 1194189 □ UPC# 661120746942

### .45 ACP KIT

PRODUCT# 1194191 □ UPC# 661120746966

patents: aob.com/patents

## F-1 SINGLE STAGE PRESS

PRODUCT# 1122194 □ UPC# 661120081449

- LINEAR RAM BEARING PROVIDES SMOOTH OPERATION AND WEAR REDUCTION
- INTEGRATED LED LIGHT FOR ENHANCED WORKSPACE VISIBILITY
- USES STANDARD DIES AND SHELL HOLDERS - NO SPECIAL PARTS REQUIRED
- FULLY CONTAINED SPENT PRIMER CATCH ENSURES NO MESS

The Frankford Arsenal F-1 Single Stage Press is packed with innovative features to help you reload precisely and quickly so you spend less time reloading and more time on the range. At its core, the press features a linear ball bearing system for smooth operation, an integrated LED light, a fully contained primer catch system, and precision-machined solid steel construction. Compatible with standard 7/8"x14 dies and shell holders, this press will load up to, and including, .338 Lapua cartridges.



patents: aob.com/patents

## ESSENTIALS RELOADING KIT

PRODUCT# 1198151 □ UPC# 661120655596

- INCLUDES KEY RELOADING ITEMS IDEAL FOR ANYONE GETTING STARTED IN RELOADING
- \$65 SAVINGS ON BUNDLED KIT

The Frankford Arsenal Essential Reloading Kit is a great all-encompassing option for anyone looking to get into the reloading space. This kit contains quality, easy-to-use reloading tools to make the process as straightforward and enjoyable as possible. Products included in the kit: The Frankford Arsenal F-1 Single Stage Press, Bench Top Powder Measure, Aluminum Powder Funnel Kit, Perfect Seat Hand Primer, Electronic Calipers, DS-750 Powder Scale, Powder Trickler, and Universal Reloading Tray.



## ROTARY TUMBLER LITE ESSENTIALS KIT

PRODUCT# 1199452 □ UPC# 661120747277

- KIT INCLUDES THE ESSENTIAL TOOLS NEEDED FOR ROTARY TUMBLING
- OVER \$70 SAVINGS ON BUNDLED KIT

The Rotary Tumbler Lite Essentials Kit provides the key rotary tumbling cleaning tools needed to make your brass look brand new. This all-in-one package includes the Frankford Arsenal Rotary Tumbler Lite, Wet/Dry Media Separator, and 2lbs of stainless steel media.



patents: aob.com/patents

## ROTARY TUMBLER LITE PROFESSIONAL KIT

PRODUCT# 1199453 □ UPC# 661120747284

- KIT INCLUDES ALL THE TOOLS NECESSARY TO PERFORM ROTARY TUMBLING & BRASS DRYING
- OVER \$100 SAVINGS ON BUNDLED KIT

The Rotary Tumbler Lite Professional Kit provides everything needed to perform rotary tumbling brass cleaning from start to finish. This all-encompassing bundle includes the Frankford Arsenal Rotary Tumbler Lite, Wet/Dry Media Separator, Brass Dryer, and 2lbs of stainless steel media.



patents: aob.com/patents

## BENCH TOP POWDER MEASURE WITH STAND

PRODUCT# 1136233 □ UPC# 661120260110

- STATIC-FREE ALUMINUM BODY TO ELIMINATE POWDER CLINGING
- NOZZLE DESIGN WORKS WITH MOST CARTRIDGES .22 - .50 CAL.
- UNIQUE HOPPER GEOMETRY PREVENTS BRIDGING AND BINDING OF POWDER
- MICROMETER POWDER STEM FOR PRECISE WEIGHT ADJUSTMENTS FROM 10 - 100 GRAINS

The Frankford Arsenal Bench Top Powder Measure features a static-free aluminum body and a unique hopper shape to eliminate powder bridging and binding. The drum rides in ball bearings for ultra-smooth operation and the micro-adjustable dispense feature ensures maximum accuracy. The powder measure comes ready to install with a bench top stand.



patents: aob.com/patents

## PISTOL MICROMETER KIT

PRODUCT# 1145115 □ UPC# 661120260127

- STAINLESS STEEL DRUM
- POWDER CHARGE RANGE: 2.5 - 50 GRAINS
- WORKS WITH BENCH TOP POWDER MEASURE
- MICROMETER POWDER STEM FOR PRECISE WEIGHT ADJUSTMENTS

The Pistol Micrometer Kit is for use in the Frankford Arsenal Bench Top Powder Measure. The stainless steel drum and precision micrometer stem ensure accurate powder charges from 2.5 - 50 grains.



patents: aob.com/patents

## REPLACEMENT POWDER RESERVOIR

PRODUCT# 1145117 □ UPC# 661120260134

- COMPATIBLE WITH BENCH TOP POWDER MEASURE AND X-10 POWDER MEASURE ASSEMBLY



## PERFECT FIT RELOADING TRAYS

- PRECISE CASE FIT PREVENTS WOBBLING AND POWDER SPILLAGE
- 2 PACK KEEPS BATCHES OF BRASS SEPARATED DURING RELOADING
- NUMBERED FOR EASY CALIBER IDENTIFICATION
- 9 TRAY OPTIONS FIT MOST POPULAR CALIBERS

Frankford Arsenal's Perfect Fit Gen 2 Reloading Trays are sized for individual calibers or a family of calibers for a precise fit. These trays are an essential tool for any reloader to maximize efficiency and stay organized. 9 tray sizes are available for many popular rifle and pistol cartridges. Sold in a convenient 2-pack, each tray securely holds 50 cases.

### TRAY #2

(5.56/.223 REM, .300 AAC)  
PRODUCT# 1183635 □ UPC# 661120746836

### TRAY #3

(9MM LUGER)  
PRODUCT# 1183637 □ UPC# 661120746843

### TRAY #4

(.38 SPL, .357 MAG)  
PRODUCT# 1183638 □ UPC# 661120746850

### TRAY #4S

(.38 SUPER, .40 S&W)  
PRODUCT# 1183639 □ UPC# 661120746867

### TRAY #5

(.308 WIN, 6.5 CM)  
PRODUCT# 1183640 □ UPC# 661120746874

### TRAY #5S

(.45 ACP)  
PRODUCT# 1183641 □ UPC# 661120746881

### TRAY #6

(.45 COLT, .44 REM MAG)  
PRODUCT# 1183642 □ UPC# 661120746898

### TRAY #7

(7MM REM MAG, .300 WIN MAG)  
PRODUCT# 1183643 □ UPC# 661120747390

### TRAY #8

(.338 LAPUA, .45-70 GOV.)  
PRODUCT# 1183644 □ UPC# 661120747406



VISIT [FRANKFORDARSENAL.COM](http://FRANKFORDARSENAL.COM) FOR COMPLETE LIST OF COMPATIBLE CALIBERS.

## ALUMINUM POWDER FUNNEL KIT

PRODUCT# 1136021 □ UPC# 661120260073

- 8 INTERCHANGEABLE NOZZLES TO FIT MOST CALIBERS
- STATIC-FREE ALUMINUM CONSTRUCTION ELIMINATES POWDER CLINGING
- LASER-MARKED NOZZLES FOR EASY CALIBER IDENTIFICATION
- INCLUDED STORAGE CASE FOR EASY ORGANIZATION OF FUNNEL AND NOZZLES

The Frankford Arsenal Aluminum Powder Funnel Kit helps you easily fill cases .17 caliber and up with precision by virtually eliminating incidences of spilled powder and static cling. Each nozzle is laser engraved by caliber for easy identification and features an O-ring for a tight seal. A sleek black non-stick surface keeps your powder static-free and eliminates occurrences of spilled powder for a safe, clean workbench and consistent loads.

patents: aob.com/patents





# FRANKFORD ARSENAL®



RETURNING PRODUCTS

LAPUA

4PH022L  
6 MM CREEDMOOR  
50 CASES

Passion for Precision

## INTELLIDROPPER® ELECTRONIC POWDER MEASURE

PRODUCT# 1082250 □ UPC# 661120412755

- LARGE BACK-LIT LCD DISPLAY WITH EASY TO SEE CONTROLS
- COMPANION APP FOR STORING LOAD DATA
- AUTO AND MANUAL TRICKLE CAPABILITY
- CONNECTS TO SMART DEVICE VIA BLUETOOTH

The Frankford Arsenal Intellidropper is the most advanced, intelligent, and precise electronic powder measure on the market today. The Intellidropper features a proprietary powder calibration function for fast and accurate powder measurements. Auto and manual trickle capabilities deliver up to 250 grains of powder per throw. The powder reservoir holds more than 7,000gr (1lb) of powder and has a convenient drain tube to empty any unused powder. The Intellidropper dispenses powder two times faster than other powder measures on the market while still offering +/- 0.1 gr accuracy. Quickly set up loads or make adjustments on the large, easy to see, back-lit LCD screen. The Frankford Arsenal Intellidropper app makes reloading your ammunition easier than ever. Connect via Bluetooth® to completely control your Intellidropper directly from your smart device. The companion app will store your load recipes and data and also features a cost center calculator which provides the user a detailed price list of how much each round costs to build.



patents: aob.com/patents

## M-PRESS® COAXIAL RELOADING PRESS

PRODUCT# 1097879 □ UPC# 661120416760

- EASY-TO-ADJUST INTEGRAL "FLOATING" SHELL-HOLDER PLATE SYSTEM
- QUICK-CHANGE, STANDARD 7/8"-14 RELOADING DIE SYSTEM
- INTEGRATED LED LIGHT FOR ENHANCED WORKSPACE VISIBILITY
- INCLUDES 3 DIE BLOCKS

The Frankford Arsenal M-Press was designed for the serious reloader to deliver the most precise ammunition possible. We engineered a reloading press with an easy to adjust universal shell holder system, an easy to empty spent primer tray, and the ability for your press to cam over or not. In combination with the easy to adjust universal shell holder system, it allows you to switch between small to magnum pistol or rifle sized cases with the turn of a dial. Our floating die system allows for optimal bullet to case alignment helping to minimize runout to help produce the most accurate ammunition possible.



patents: aob.com/patents

## UNIVERSAL BULLET SEATING DIE

PRODUCT# 1116715 □ UPC# 661120079507

- PRECISION MICRO-ADJUSTABLE SEATING DEPTH
- WORKS FOR .224 - .338 CAL AND HAS A STANDARD 7/8 X 14 THREAD
- VLD BULLET SEATING STEMS PREVENT DAMAGING BULLET TIPS
- BULLET ALIGNMENT SLEEVES, 3 CLD BULLET SEATING STEMS AND A MOLDED STORAGE CASE

The Universal Bullet Seating Die works with .224 to .338 caliber bullets. Featuring a cutout window die body, the Universal Bullet Seating Die holds the bullet in place while seating. The built-in micrometer allows for precise .001" micro-adjustments to the seating depth of the bullet. Includes 9 bullet alignment sleeves, 3 VLD bullet seating stems, and a molded storage case.



patents: aob.com/patents

## ROTARY TUMBLER KIT

PRODUCT# 909544 □ UPC# 661120095446

- LARGE 7 LITER CAPACITY, TUMBLES UP TO 1,000 CASES OF .223 BRASS
- DUAL-LAYER DRUM WITH NOISE DAMPENING RUBBER LINING
- INCLUDES 5 LBS OF STAINLESS STEEL MEDIA PINS
- MAINTENANCE-FREE GEARED DRIVETRAIN

The Frankford Arsenal Rotary Tumbler delivers a whole new level of brass cleaning performance. When rotary tumbled with our stainless steel pins in a liquid bath, brass will get much cleaner and work much faster than ultrasonic or vibratory tumbling methods. The small stainless pins remove carbon from inside cases and primer pockets to deliver like new brass. A built-in timer in the base can be set to run from 0 to 3 hours shutting off automatically. The tumbler can effectively clean without the use of stainless media pins with a mixture of Frankford Brass Cleaning Solution and water (use of media pins ensures primer pockets and inside of cases are perfectly clean). It's the most effective brass cleaning process available with a large 7 liter capacity.



patents: aob.com/patents

### 230V (INTERNATIONAL)

PRODUCT# 909567 □ UPC# 661120095675

### 240V (INTERNATIONAL)

PRODUCT# 1097882 □ UPC# 661120416791

## ROTARY TUMBLER LITE

PRODUCT# 1097878 □ UPC# 661120416753

- 3.3 LITER CAPACITY HOLDS UP TO 300 CASES OF .223 BRASS
- EASY TWIST CAP WITH CLEAR WINDOW TO VIEW TUMBLING AND LEAK-PROOF CAP DESIGN
- MAINTENANCE-FREE GEARED DRIVETRAIN
- WORKS GREAT WITH STAINLESS STEEL PINS (NOT INCLUDED)

The Frankford Arsenal Rotary Case Tumbler Lite is the compact version of the Rotary Tumbler. This tumbler can hold up to 300 pieces of .223 brass. The Rotary Tumbler Lite is especially great for reloading specialty cartridges and lower volume. One of the best features is its maintenance free, geared drivetrain. The leak proof cap is clear to allow you to check up on the tumbling action while keeping your reloading area clean and dry.



### 230V (INTERNATIONAL)

PRODUCT# 1097881 □ UPC# 661120416791

patents: aob.com/patents

## ROTARY TUMBLER STRAINING CAPS

PRODUCT# 1097883 □ UPC# 661120416807

- PACKAGE OF 2
- COMPATIBLE WITH FRANKFORD ARSENAL ROTARY TUMBLER AND ROTARY TUMBLER LITE
- ALLOWS YOU TO STRAIN THE TUMBLING DRUM WITHOUT LOSING ANY CASINGS OR MEDIA PINS

Separate your brass from cleaning solution with Frankford Arsenal Sifting Caps. These sifting caps easily fit over the top of the Frankford Arsenal Rotary Tumbler drums, so you can easily pour all liquids from the container while keeping your brass contained.





## ROTARY TUMBLER SPARE DRUM

PRODUCT# 909789 □ UPC# 661120097891

- 7 LITER CAPACITY
- DUAL-LAYER DRUM WITH NOISE DAMPENING RUBBER LINING
- COMPATIBLE WITH ROTARY TUMBLER KIT (7L)
- 2 END CAP ASSEMBLIES INCLUDED



## STAINLESS STEEL TUMBLING MEDIA 2 LBS

PRODUCT# 1097884 □ UPC# 661120416814

- PERFECT AMOUNT FOR USE WITH THE FRANKFORD ARSENAL ROTARY TUMBLER LITE
- PINS SCRUB INSIDE THE CASE BODY AS WELL AS INSIDE THE PRIMER POCKETS
- 304 MAGNETIC STAINLESS STEEL
- LIFETIME USE

Frankford Arsenal Stainless Steel Tumbling Media is ideal for rotary tumbling brass. When combined with a liquid bath they deliver unmatched cleaning performance. Constructed of high quality 304 stainless steel, the media pins effectively penetrate inside of cases and primer pockets. 304 Stainless Steel. Ideal for Rotary Tumbling. Magnetic for convenient handling and lifetime use.



## STAINLESS STEEL TUMBLING MEDIA 5 LBS

PRODUCT#909191 □ UPC# 66112009191

- PERFECT AMOUNT FOR USE WITH THE FRANKFORD ARSENAL ROTARY TUMBLER
- PINS SCRUB INSIDE THE CASE BODY AS WELL AS INSIDE THE PRIMER POCKETS
- 304 MAGNETIC STAINLESS STEEL
- LIFETIME USE

Frankford Arsenal Stainless Steel Tumbling Media is ideal for rotary tumbling brass. When combined with a liquid bath they deliver unmatched cleaning performance. Constructed of high quality 304 stainless steel, the media pins effectively penetrate inside of cases and primer pockets. 304 Stainless Steel. Ideal for Rotary Tumbling. Magnetic for convenient handling and lifetime use.



## MEDIA TRANSFER MAGNET

PRODUCT# 909271 □ UPC# 661120092711

- EASILY HANDLE AND TRANSFER 304 STAINLESS MEDIA PINS
- GATHERS THEN RELEASE WHEN HANDLE IS PULLED

The Frankford Arsenal Media Transfer Magnet is ideal for handling the 304 stainless steel media pins that come with the Platinum Series Rotary Tumbler. This magnet effectively gathers and then releases pins with a pull of the handle. The Media Transfer Magnet makes separating pins from brass fast and convenient.



patents: aob.com/patents

## WET/DRY MEDIA SEPARATOR

PRODUCT# 507567 □ UPC# 661120075677

- DESIGNED FOR WET AND DRY MEDIA SEPARATION
- KEEPS COMPONENTS ENCLOSED FOR EASY CLEANUP AND STORAGE
- SPILL PROOF TUB FULLY CAPTURES WATER, DRY MEDIA AND STAINLESS STEEL PINS
- A RUGGED RUBBER LATCH KEEPS THE SIFTER CLOSED

The Frankford Arsenal Wet/Dry Media Separator is ideal for all reloaders. After your casings have tumbled, this sifter allows for easy separation of brass and cleaning media. With built in straining caps you can separate and rinse components without worry of washing them into the sink.



## BRASS DRYER

PRODUCT# 909213 □ UPC# 661120092131

- DRIES BRASS AFTER ROTARY TUMBLING OR ULTRASONIC CLEANING IN UNDER AN HOUR
- HOLDS UP TO 1,000 PIECES OF .223 BRASS OR 2,000 PIECES OF 9MM BRASS
- INCLUDES 5 REMOVEABLE TRAYS
- TEMPERATURE CONTROL FROM 90°-160°F

The Frankford Arsenal Brass Dryer is a quick, convenient, and efficient system for drying your brass. This dryer is the perfect tool for drying your rifle and pistol brass after wet case cleaning processes such as rotary tumbling or ultrasonic cleaning.



### 220V (INTERNATIONAL)

PRODUCT# 110123 □ UPC# 61120001355

## QUICK-N-EZ™ ROTARY SIFTER KIT WITH BUCKET

PRODUCT# 507565 □ UPC# 661120075653

- INCLUDES: ROTARY SEPARATOR, PLASTIC BUCKET, 2 BUCKET SUPPORTS AND 2 SPLASH FINS
- HANDLE CAN BE INSTALLED ON EITHER SIDE FOR AMBIDEXTROUS USE
- DESIGNED FOR WET AND DRY MEDIA SEPARATION

Includes Quick-N-EZ Rotary Separator, Plastic Bucket, 2 bucket supports and 2 splash fins (with plastic bucket). The Quick-N-EZ Rotary Separator is perfect for separating the stainless steel pins from your brass after rotary tumbling.



## QUICK-N-EZ™ VIBRATORY TUMBLER

PRODUCT# 855020 □ UPC# 661120550204

- HIGH CAPACITY BOWL HOLDS UP TO 600 9MM OR 350 .223 CASES
- QUICK, EASY AND ECONOMICAL MEANS TO CLEAN YOUR BRASS
- REMOVES FOULING, LUBE AND OXIDATION QUICKLY AND CONVENIENTLY
- WORKS GREAT WITH FRANKFORD ARSENAL CORN COB OR WALNUT MEDIA

The Frankford Arsenal Quick-N-EZ Vibratory Tumbler provides a quick, easy and economical means to cleaning your brass. Used in conjunction with Frankford Arsenal Walnut or Corn Cob Medias, the Quick-N-EZ Case Tumbler removes fouling, lube and oxidation quickly and conveniently. The tumbler bowl will hold up to 600 9mm or 350 .223 cases.

**220V (INTERNATIONAL)**

PRODUCT# 515667 □ UPC# 661120156673



patents: aob.com/patents

## QUICK-N-EZ™ VIBRATORY TUMBLER KIT

PRODUCT# 645880 □ UPC# 661120458807

- HIGH CAPACITY BOWL HOLDS UP TO 600 9MM OR 350 .223 CASES
- QUICK, EASY AND ECONOMICAL MEANS TO CLEAN YOUR BRASS
- REMOVES FOULING, LUBE AND OXIDATION QUICKLY AND CONVENIENTLY
- WORKS GREAT WITH FRANKFORD ARSENAL CORN COB OR WALNUT MEDIA

The Frankford Arsenal Case Tumbler provides a quick, easy and economical means to clean your brass. Used in conjunction with the Frankford Arsenal walnut and corn cob media, the Quick-N-EZ Tumbler removes lube and oxidation quickly and conveniently. It will hold up to 600 9mm or 350 .223 cases. The Kit includes Quick-N-EZ Case Tumbler, Quick-N-EZ Rotary Media Separator, 4 oz Brass polish, 3 lb Cleaning Media and a Plastic Bucket.

**220V (INTERNATIONAL)**

PRODUCT# 799534 □ UPC# 661120995340

patents: aob.com/patents



## QUICK-N-EZ™ ROTARY SEPARATOR

PRODUCT# 683551 □ UPC# 661120835516

- INCLUDES: ROTARY SEPARATOR, 2 BUCKET SUPPORTS AND 2 SPLASH FINNS
- HANDLE CAN BE INSTALLED ON EITHER SIDE FOR AMBIDEXTROUS USE
- DESIGNED FOR WET AND DRY MEDIA SEPARATION

Includes Quick-N-EZ Rotary Separator, 2 bucket supports and 2 splash fins (with plastic bucket). The Quick-N-EZ Rotary Separator is perfect for separating the stainless steel pins from your brass after rotary tumbling.



## QUICK-N-EZ™ STANDARD MEDIA SEPARATOR

PRODUCT# 121925 □ UPC# 661120447276

- CAPACITY TO HOLD A BRASS TUMBLER WORTH OF CASES AND MEDIA
- SITS CONVENIENTLY ON TOP OF MOST 3.5 AND 5 GALLON PLASTIC BUCKETS
- PERFORATED BOTTOM LETS MEDIA FALL THROUGH, LEAVING CLEAN BRASS BEHIND
- CONSTRUCTED OF DURABLE, LIGHTWEIGHT PLASTIC



## CORN COB MEDIA (UNTREATED)

**4.5 LB:** PRODUCT# 287178 □ UPC# 661120448303

**7 LB:** PRODUCT# 108729 □ UPC# 661120087298

**15 LB BOX:** PRODUCT# 446063 □ UPC# 661120460633

**15 LB BUCKET (3.5 GALLON):** PRODUCT# 687756 □ UPC# 661120877561

- DESIGNED TO QUICKLY AND EFFICIENTLY REMOVE DIRT, GRIT AND POWDER RESIDUE FROM BRASS CASES BEFORE RELOADING
- ADD FRANKFORD ARSENAL BRASS POLISH FOR A FACTORY SHINE
- USED TO CLEAN/POLISH MEDIA AND CAN ALSO BE USED TO FILL SHOOTING BAGS FOR THE RANGE
- CAN BE USED MULTIPLE TIMES BEFORE NEEDING TO CHANGE OUT WITH NEW MEDIA

Clean brass should be the goal of every reloader. Cleaning brass by tumbling is the economical, safe first step in assembling quality handloads. Besides ensuring long life for the most valuable component of your ammunition, cleaning your brass will help reduce wear and tear on your expensive reloading dies, not to mention the chamber of your firearm. Grit and grime from uncleaned brass can become imbedded in the inner surfaces of your sizing dies, scratching and marring every subsequent case. The same grime can be expected to accelerate wear in the chamber and feeding system of your rifle or handgun.



## CORN COB MEDIA (TREATED)

PRODUCT# 194524 □ UPC# 661120448310

- 4.5 LB CONTAINER
- PRE-TREATED WITH BRASS POLISH
- DESIGNED TO QUICKLY AND EFFICIENTLY REMOVE DIRT, GRIT AND POWDER RESIDUE FROM BRASS CASES BEFORE RELOADING
- CAN BE USED MULTIPLE TIMES BEFORE NEEDING TO CHANGE OUT WITH NEW MEDIA

Clean brass should be the goal of every reloader. Cleaning brass by tumbling is the economical, safe first step in assembling quality handloads. Besides ensuring long life for the most valuable component of your ammunition, cleaning your brass will help reduce wear and tear on your expensive reloading dies, not to mention the chamber of your firearm. Grit and grime from uncleaned brass can become imbedded in the inner surfaces of your sizing dies, scratching and marring every subsequent case. The same grime can be expected to accelerate wear in the chamber and feeding system of your rifle or handgun.



## WALNUT MEDIA (UNTREATED)

**5 LB:** PRODUCT# 881538 □ UPC# 661120448129

**18 LB BOX:** PRODUCT# 496169 □ UPC# 661120087298

**18 LB BUCKET (3.5 GALLON):** PRODUCT# 636314 □ UPC# 661120961697

- DESIGNED TO QUICKLY AND EFFICIENTLY REMOVE DIRT, GRIT AND POWDER RESIDUE FROM BRASS CASES BEFORE RELOADING
- ADD FRANKFORD ARSENAL BRASS POLISH FOR A FACTORY SHINE
- USED TO CLEAN/POLISH MEDIA AND CAN ALSO BE USED TO FILL SHOOTING BAGS FOR THE RANGE
- CAN BE USED MULTIPLE TIMES BEFORE NEEDING TO CHANGE OUT WITH NEW MEDIA

Clean brass should be the goal of every reloader. Cleaning brass by tumbling is the economical, safe first step in assembling quality handloads. Besides ensuring long life for the most valuable component of your ammunition, cleaning your brass will help reduce wear and tear on your expensive reloading dies, not to mention the chamber of your firearm. Grit and grime from uncleaned brass can become imbedded in the inner surfaces of your sizing dies, scratching and marring every subsequent case. The same grime can be expected to accelerate wear in the chamber and feeding system of your rifle or handgun.



## WALNUT MEDIA (TREATED)

**5 LB:** PRODUCT# 347338 □ UPC# 661120448808

**7 LB BOX:** PRODUCT# 331177 □ UPC# 661120311775

- DESIGNED TO QUICKLY AND EFFICIENTLY REMOVE DIRT, GRIT AND POWDER RESIDUE FROM BRASS CASES BEFORE RELOADING
- PRE-TREATED WITH BRASS POLISH
- USED TO CLEAN/POLISH MEDIA AND CAN ALSO BE USED TO FILL SHOOTING BAGS FOR THE RANGE
- CAN BE USED MULTIPLE TIMES BEFORE NEEDING TO CHANGE OUT WITH NEW MEDIA

Clean brass should be the goal of every reloader. Cleaning brass by tumbling is the economical, safe first step in assembling quality handloads. Besides ensuring long life for the most valuable component of your ammunition, cleaning your brass will help reduce wear and tear on your expensive reloading dies, not to mention the chamber of your firearm. Grit and grime from uncleaned brass can become imbedded in the inner surfaces of your sizing dies, scratching and marring every subsequent case. The same grime can be expected to accelerate wear in the chamber and feeding system of your rifle or handgun.



## BRASS CLEANING PACKS

PRODUCT# 110040 □ UPC# 661120000471

- QUICK AND EFFECTIVE NEW CRYSTALLIZED, WATER-SOLUBLE FORMULA
- FOR USE WITH FRANKFORD ARSENAL ROTARY TUMBLERS
- 1 PACK CLEANS 500 PIECES OF BRASS
- 24 COUNT

The quick and effective way to clean your brass is finally here with the Frankford Arsenal Brass Cleaning Packs. These packs are conveniently prepackaged and measured for cleaning 500 pieces of brass. You can also take pride in knowing that your cleaning solution is made right here in the U.S.A. This reloading cleaning solution was designed for use with the Frankford Arsenal Rotary Tumbler, but can be used with a variety of wet reloading tumblers.



patents: aob.com/patents

## BRASS CLEANING SOLUTION

PRODUCT# 878787 □ UPC# 661120787877

- 32 OZ. SUPER CONCENTRATED FORMULA MAKES 10 GALLONS OF SOLUTION (40:1 RATIO)
- SCIENTIFICALLY FORMULATED TO QUICKLY REMOVE CARBON BUILDUP, TARNISH AND OXIDATION ON BRASS
- LEAVES BRASS CASES CLEAN & SHINY
- USE WITH DISTILLED WATER FOR BEST RESULTS



## PILE DRIVER® BULLET PULLER

PRODUCT# 1116083 □ UPC# 661120079408

- DUAL SPRING POWERED ACTION DELIVERS POWERFUL AND CONSISTENT PULL FORCE
- LOW EFFORT LEVER DESIGN MAKES BULLET PULLING QUICK AND EASY
- QUICK CHANGE COLLET SYSTEM ACCEPTS
- TWO OPTIONS FOR NO MESS POWDER AND BULLET COLLECTION

Tired of using traditional methods to pull bullets? Simply attach the Pile Driver Bullet Puller to your workbench or wall and experience easy bullet extracting. The easy lever design uses dual spring power to pull bullets up to .30-06, and an additional carrier will pull bullets up to .338 Lapua length. Bullets and powder are captured in an included trap or an optional barbed fitting is provided for attaching a tube to collect with ease.



patents: aob.com/patents

## PILE DRIVER® STANDARD CARRIER ASSEMBLY

PRODUCT# 1132927 □ UPC# 661120103707

- COMPATIBLE WITH THE FRANKFORD ARSENAL PILE DRIVER BULLET PULLER
- FITS UP TO .30-06 CASE HEAD



patents: aob.com/patents

## PILE DRIVER® MAGNUM CARRIER ASSEMBLY

PRODUCT# 1132857 □ UPC# 661120103714

- COMPATIBLE WITH THE FRANKFORD ARSENAL PILE DRIVER BULLET PULLER
- FITS .30-06 TO .338 LAPUA CASE HEAD



patents: aob.com/patents

## QUICK-N-EZ™ IMPACT BULLET PULLER

PRODUCT# 836017 □ UPC# 661120446422

- 3 DIFFERENT COLLETS FITS ALMOST ANY CALIBER FROM .22 HORNET TO .45-70
- FUNCTIONS WITH RIMMED AND RIMLESS CASES
- COMPATIBLE WITH CAST BULLETS
- WORKS ON RIFLE AND PISTOL CASES

The Frankford Arsenal Quick-N-EZ Impact Bullet Puller makes pulling bullets a simple process. Just insert the loaded round and sternly tap the Bullet Puller against a piece of wood to separate the bullet from the brass.



## M-PRESS® DIE BLOCKS

PRODUCT# 1097880 □ UPC# 661120416777

- SET OF 3
- COMPATIBLE WITH THE FRANKFORD ARSENAL M-PRESS COAXIAL RELOADING PRESS
- SET SCREW HOLDS DIES FIRMLY IN PLACE
- STORAGE CASE INCLUDED

Purchase an additional die block set for each of the calibers you reload. Save time setting up your workbench and spend more time reloading. Each die block features a lock screw to ensure the die returns to the proper setting each time. Protect your die blocks and dies in the included stackable storage case when they're not in use.



## DIGITAL CALIPERS

PRODUCT# 672060 □ UPC# 661120720607

- ACCURATELY MEASURES OBJECTS UP TO 6" WITH SAE TO METRIC CONVERSION
- LCD SCREEN FOR EASY READOUT
- MEASURES DEPTH, STEP, INSIDE AND OUTSIDE DIAMETERS
- STORAGE CASE INCLUDED

Reloading ammunition requires attention to many critical cartridge dimensions, including case length, neck and base diameters, overall length, primer pocket depth, etc. Verifying these dimensions is quick and convenient with the Frankford Arsenal Calipers and Micrometers. The calipers are accurate to within .001" and allow you to measure step, inside and outside diameters, plus depths and displays the measurements on the LCD screen located on the front. You will find them useful for many measuring tasks on and off the reloading bench. Packaged in a convenient, protective case.



patents: aob.com/patents

## DIAL CALIPERS

PRODUCT# 516503 □ UPC# 661120440642

- ACCURATELY MEASURES OBJECTS UP TO 6"
- HARDENED STAINLESS STEEL RACK FOR DURABILITY
- MEASURES DEPTH, STEP, INSIDE AND OUTSIDE DIAMETERS
- STORAGE CASE INCLUDED

Reloading ammunition requires attention to many critical cartridge dimensions, including case length, neck and base diameters, overall length, primer pocket depth, etc. Verifying these dimensions is quick and convenient with the Frankford Arsenal Dial Calipers. The calipers are accurate to within .001" and allow you to measure step, inside and outside diameters, plus depths. You will find them useful for many measuring tasks on and off the reloading bench. Packaged in a convenient, protective case.





## PRECISION SCALE

PRODUCT# 909672 □ UPC# 661120096726

- +/- 0.1 GRAIN ACCURACY FOR CONSISTENT AND PRECISE MEASUREMENTS
- MEASUREMENTS IN GRAINS, GRAMS, CARATS, AND OUNCES
- 1,500 GRAIN CAPACITY
- RUNS ON A/C POWER OR 4-AAA BATTERIES (NOT INCLUDED)

This versatile reloading scale is perfect for any reloading room. With the ability to measure in several different units and the 3 point calibration feature, it can easily be relied on for most all reloading needs. The weigh plate is shaped to accept a powder pan as well as indexed to fit the shaft of an arrow or any other like-shaped objects. This scale also features a Tare button that allows for measuring the consistency between loads.



## DS-750 DIGITAL SCALE

PRODUCT# 205205 □ UPC# 661120052050

- +/- 0.1 GRAIN ACCURACY FOR FOR CONSISTENT AND PRECISE MEASUREMENTS
- MEASUREMENTS IN GRAINS, GRAMS, CARATS, AND OUNCES
- 750 GRAIN CAPACITY
- POWERED BY 2-AAA BATTERIES (INCLUDED)

The Frankford Arsenal DS-750 Digital Reloading Scale delivers extreme accuracy for precise measurement of powder, bullets, cases or loaded rounds. Simple controls allow for easy changes of units and calibration. Powder pan, carry bag, calibration weight and 2-AAA batteries included.



## UNIVERSAL RELOADING TRAY

PRODUCT# 393939 □ UPC# 661120939399

- 50 ROUND CAPACITY
- ACCOMMODATES SEVERAL DIFFERENT BRASS CARTRIDGES IN THE SAME HOLE
- ACCEPTS A WIDE VARIETY OF CARTRIDGES FROM .17 TO .458 CALIBER
- TOP SIDE HOLDS PISTOL AND RIFLE BRASS, BOTTOM SIDE HOLDS 9MM AND .45 ACP BRASS

The Universal Reloading Tray is highly versatile. It can be used with a wide variety of rifle cartridges from .17 caliber up to .458 caliber. It also works well for handgun cartridges 9mm to 500 S&W. 50 round capacity.



## CASE TRIM AND PREP SYSTEM

PRODUCT# 903156 □ UPC# 661120031567

- ADJUSTABLE COLLET SYSTEM WORKS WITH ALL CASES FROM .17 REMINGTON TO .460 WEATHERBY
- ULTRA-HARD HSS CUTTERS STAY SHARP FOR THOUSANDS OF ROUNDS
- THREE OUTPUT SHAFTS ACCEPT ALL CASE TRIMMING ACCESSORIES WITH 8-32 THREADS
- INCLUDES VLD INSIDE CHAMFER TOOL, OUTSIDE DEBURR TOOL, SMALL AND LARGE PRIMER POCKET CLEANER

The Frankford Arsenal Case Trim and Prep Center houses all the tools you need to trim, chamfer, deburr, and pocket clean. An innovative case holder with adjustable collet and bushing system indexes the case shoulder and can be set to precisely trim brass to an exact length. Built from aluminum and a durable steel frame, the Case Trim and Prep Center is built to be a long-term tool on your reloading bench.



### 240V (INTERNATIONAL)

PRODUCT# 1094737 □ UPC# 661120416821

patents: aob.com/patents

## CASE PREP CENTER

PRODUCT# 1077094 □ UPC# 61120412885

- FOUR OUTPUT SHAFTS ACCEPT ALL CASE TRIMMING ACCESSORIES WITH 8-32 THREADS
- HARDENED HIGH SPEED STEEL (HSS) TOOLS STAY SHARP FOR THOUSANDS OF ROUNDS
- INCLUDES INSIDE CHAMFER TOOL, OUTSIDE DEBURR TOOL, SMALL AND LARGE PRIMER POCKET CLEANER
- 200 RPM OUTPUT MAKES CASE PREP QUICK AND EASY

The Frankford Arsenal Case Prep Center makes case preparation an easy process. Its compact design makes it ideal for all reloading benches. With four hardened high-speed steel tools, the Case Prep Center includes everything you need to quickly prepare of brass casings. The durable aluminum body has a slot to store all of your cutting tools.



## PRIMER POCKET PREP KIT

PRODUCT# 909215 □ UPC# 661120092155

- STANDARD 8-32 THREADS FITS FRANKFORD ARSENAL CASE TRIM & PREP CENTERS
- HARDENED HIGH SPEED STEEL (HSS) STAYS SHARP FOR THOUSANDS OF ROUNDS
- SMALL AND LARGE PRIMER POCKET UNIFORMER/CLEANER
- SMALL AND LARGE PRIMER POCKET CRIMP REMOVER



## UNIVERSAL PRECISION CASE TRIMMER

PRODUCT# 1092514 □ UPC# 661120416746

- TRIMS SHOULDERS CASES FROM .17 REM TO .460 WEATHERBY
- BUILT-IN DEPTH MICROMETER ADJUSTS IN 0.001" INCREMENTS
- ULTRA HARD HSS CUTTER WILL STAY SHARP FOR THOUSANDS OF ROUNDS
- WORKS WITH ANY STANDARD DRILL OR DRILL PRESS

The Universal Precision Case Trimmer is the same great technology found on the Case Prep and Trim Center, however, it is designed to be used with a standard drill or mounted in a drill press. Unlike conventional trimmers, the Universal Drill Trimmer requires no caliber specific pilots or shellholders. The included collets index off the case shoulder to trim any shouldered case from 17 Remington to 460 Weatherby Magnum. Simply install the correct collet, adjust the trimmer to your desired length, then secure the trimmer into a drill or drill press. Cases are then fed into the trimmer by hand. With a little practice, the Universal Drill Trimmer will trim cases faster than any traditional trimmer you've ever used.

patents: aob.com/patents



## CASE PREP ESSENTIALS KIT

PRODUCT# 909214 □ UPC# 661120092148

- INSIDE CHAMFER TOOL & OUTSIDE DEBURR TOOL
- SMALL AND LARGE PRIMER UNIFORMER/CLEANER
- SMALL AND LARGE PRIMER POCKET CRIMP REMOVAL TOOLS
- MADE OF HARDENED HIGH SPEED STEEL

The Frankford Arsenal Case Prep Essentials Kit includes 2 handles, inside and outside chamfer tools, large and small primer pocket uniformer/cleaner, large and small primer pocket crimp remover and a handy storage case.



## STUCK CASE REMOVER

PRODUCT# 1078192 □ UPC# 661120411338

- ADJUSTABLE CLAMP WORKS ON .17 REM.-.338 LAPUA CARTRIDGES
- PROVIDES OPTIMAL LEVERAGE WITH THE USE OF A RELOADING PRESS
- CASE REMOVAL WITH NO EXTRA TOOLS REQUIRED
- NO NEED TO REMOVE OR ADJUST THE DIE

Get back to reloading in minutes with the Frankford Arsenal Stuck Case Remover. No need to disassemble your press or break out your other tools. Simply insert the device into the shell holder, clamp down on the case and activate the press lever to quickly and efficiently separate the case from the die. Once the case is free, remove the tool and continue to reload.



## POWDER TRICKLER

PRODUCT# 903535 □ UPC# 661120035350

- LARGE POWDER CAPACITY
- HEAVY MACHINED STEEL TO PREVENT TIP OVERS
- DUST COVER DOUBLES AS A NON-SKID BASE AND THE DISPENSER COVER
- TRICKLER HEIGHT FITS ALMOST ALL POWDER SCALES

Have control over your small powder adjustments, with the Frankford Arsenal Powder Trickler. The rubber caps serve as a protectant for the powder when not in use, while also creating a slide proof base for when in use. Simply turn the arm to drop minimal amounts of powder at a time to ensure a more accurate weight. This tool works perfect with digital reloading scales and is the perfect addition to any reloading room.



## HAND DEPRIMER

PRODUCT# 909283 □ UPC# 661120092834

- PATENTED UNIVERSAL COLLET SYSTEM DEPRIMES BRASS FROM .20 CAL UP TO .338 LAPUA
- COMES WITH 3 DIFFERENT COLLETS FOR DIFFERENT DIAMETER CASES
- WORKS ON PISTOL BRASS, RIFLE BRASS AND MILITARY CRIMPED PRIMERS
- CONSTRUCTED WITH A FULL-LENGTH, ERGONOMIC GRIP

The Frankford Arsenal Hand Deprimer allows you to break out of the confines of the reloading room and take your depriming anywhere. With a hand operated, portable design, you can quickly and easily deprime your brass from the couch. The collection tube catches old primers and is see through to easily monitor fullness level. When the catch tube is full, simply twist off and empty. After the primer is removed, the Deprimer auto ejects the case for a faster and easier operation.



patents: aob.com/patents

## PERFECT SEAT HAND PRIMER

PRODUCT# 110006 □ UPC# 661120100065

- WORKS WITH BOTH SMALL AND LARGE PRIMERS
- 0.001" SEATING DEPTH ADJUSTMENT
- STORAGE CASE KEEPS COMPONENTS SECURE AND ORGANIZED
- 12 SHELLHOLDERS INCLUDED

The Frankford Arsenal Hand Primer allows you to break out of the confines of the reloading room and take your priming anywhere. The .001" micrometer adjustment allows you to dial in the perfect primer seating depth for ultimate accuracy and reliability. With a hand operated, portable design, you can quickly and easily prime your brass from the couch. This tool is a must have for any reloader.



patents: aob.com/patents

## VIBRA-PRIME

PRODUCT# 855712 □ UPC# 661120855712

- MAKES LOADING PRIMER TUBES QUICK AND EASY
- WORKS WITH BOTH SMALL AND LARGE PRIMERS
- CIRCULAR AUTO-INDEXING RIDGES FOR QUICK PRIMER INSERTION

The Vibra-Prime™ can load 100 primers into a primer tube in a matter of seconds with its unique motorized agitation mechanism. Filled tubes are then easily transferred into any model progressive press tube. Includes Vibra-Prime, primer tray, small and larger primer tube & 2 universal tube adapters. Runs on 2 AA batteries (not included).



## PRIMER POCKET SWAGER

PRODUCT# 110007 □ UPC# 661120100072

- PADDED ERGONOMIC HANDLE TAKES THE STRAIN OUT OF SWAGING BRASS
- SPRING LOADED DESIGN AUTO INSERTS AND EJECTS BRASS INTO SWAGER
- COMPATIBLE WITH SMALL AND LARGE PRIMER POCKETS
- STURDY DIE-CAST ALUMINUM CONSTRUCTION

Complete your reloading bench with the Frankford Arsenal Primer Pocket Swager. Easily remove military crimps with this ergonomic upright designed swager that can be clamped or permanently mounted to any workbench. You no longer have to fiddle with aligning the primer pocket perfectly, simply utilize the included large and small case holders and the easy-to-use swing out access to quickly insert, swage and remove brass.



patents: aob.com/patents

## RELOADING STAND

PRODUCT# 489621 □ UPC# 661120896210

- FRAME IS MADE OF 1.5" TUBE STEEL
- CAN BE USED WHILE SITTING OR STANDING
- INCLUDES 2 SIDE BINS FOR HOLDING COMPONENTS
- FOLDS UP FOR CONVENIENT STORAGE OR TRANSPORTATION

The Frankford Arsenal Reloading Stand is perfect for when you do not have room for a full size reloading bench or need to create a slightly altered setup. Able to handle a press and a powder measure at the same time, this highly adaptable bench also features collapsible shelves that create more space and tuck away for easy storage. Whether you are doing a quick reload, or simply need something that takes up a little less space, this reloading table is perfect for you.

Adjustable Height: 28.5"-45"  
Adjustable Width: 13"-39"



## CASE LUBE

PRODUCT# 460478 □ UPC# 661120439967

- 8 OUNCE SPRAY BOTTLE
- ELIMINATES STUCK CASES WHILE NOT CONTAMINATING THE POWDER OR PRIMERS
- FAST-DRYING TO ALLOW FOR QUICK AND EASY RESIZING



## DROP OUT

PRODUCT# 763758 □ UPC# 661120637585

- 6 OUNCE AEROSOL SPRAY CAN
- ALLOWS FOR EASY REMOVAL OF THE NEWLY CAST BULLETS FROM THE MOLD
- LONG-LASTING FORMULA TO ENSURE NO CAST GETS STUCK IN THE MOLD
- FAST-DRYING TO ALLOW FOR QUICKER CASTING OF BULLETS

Frankford Arsenal Drop Out Bullet Mold Release Agent is great for preparing your molds for casting. This product works as both a release agent and a lube. The special formula contains graphite to help bullets drop easily from the mold and works to prevent rust.



patents: aob.com/patents

## RELOADER'S LABELS

PRODUCT# 202364 □ UPC# 661120023647

- 100 LABELS PER PACKAGE
- 2" W X 2.5" H PEEL & STICK LABEL

These Peel & Stick Labels help you record all of the important data about your pistol, rifle or shotgun handloads for future reference and replication. These labels have an adhesive which makes them easy to remove. Works great with plastic ammo boxes.



## CARTRIDGE OVERALL LENGTH GAUGE

PRODUCT# 965887 □ UPC# 661120658870

- ACCURATELY DETERMINES THE MAXIMUM CARTRIDGE LENGTH FOR ANY RIFLE
- INCLUDES: 2 CLAMPS AND 3 ROD TIPS

If you have a cleaning rod and a set of calipers, you can now determine the optimum OAL for any bullet in less than two minutes. This simple kit consists of two clamps that easily attach to any cleaning rod, 1/4" in diameter, or less. Simply install the appropriate size tip on the end of your cleaning rod, insert the cleaning rod to the bolt face, install one clamp, remove the bolt and drop in a bullet (projectile only) into the chamber. Hold the bullet against the rifling with a pencil, touch the bullet tip with the cleaning rod tip and install the other clamp. Now measure the inside distance between the two clamps with calipers and record, or use as a gauge to check the seating depth set-up during your reloading sequence.



## CLEANCASST LEAD FLUX

PRODUCT# 441888 □ UPC# 661120418887

- 1 LB. CONTAINER
- IMPROVES CONSISTENCY OF MELTED LEAD
- NON-SMOKING AND ODDOR FREE

Lead fluxing made easy. No more using rosin, paraffin, tallow, bullet lube and other homemade concoctions. CleanCast is non-smoking, odor-free and it really works. Only a small amount is necessary to prepare even a 20 lb lead pot for bullet production. Separates dross from valuable bullet alloy and improves the consistency of the melted lead to eliminate variability during your casting session.



## QUICK-N-EZ™ BRASS POLISH

4 OZ: PRODUCT# 845677 □ UPC# 661120456773

8 OZ: PRODUCT# 887335 □ UPC# 661120873358

32 OZ: PRODUCT# 321901 □ UPC# 661120219019

- SPECIFICALLY DESIGNED FOR USE WITH BRASS CASES
- AMMONIA FREE, CITRUS SCENTED FORMULA
- LEAVES BRASS SHINY AND RESIDUE FREE

Frankford Arsenal Quick-N-EZ Brass Polish is a citrus scented brass polish that is specifically designed for cartridge cases. This product is ammonia free to protect your brass from becoming brittle and will not leave a residue.



## HINGE-TOP AMMO BOXES

- STACKABLE
- AVAILABLE IN 50 AND 100 ROUND BOXES
- STURDY, HINGE-TOP DESIGN WON'T BREAK WITH REPEATED USE

### 50 ROUND BOXES

#### BOX #501

PRODUCT# 1083783 □ UPC# 661120412977

#### BOX# 503

PRODUCT# 1083784 □ UPC# 661120412984

#### BOX# 504

PRODUCT# 1083785 □ UPC# 661120412991

#### BOX# 505

PRODUCT# 1083786 □ UPC# 661120413004

#### BOX# 506

PRODUCT# 1083787 □ UPC# 661120413011

#### BOX# 507

PRODUCT# 1083789 □ UPC# 661120413103

#### BOX# 508

PRODUCT# 1083792 □ UPC# 661120413110

#### BOX# 509

PRODUCT# 1083788 □ UPC# 661120413127

#### BOX# 510

PRODUCT# 1083790 □ UPC# 661120413134

#### BOX# 511

PRODUCT# 1083791 □ UPC# 661120413141

#### BOX# 512

PRODUCT# 1083793 □ UPC# 661120413158

#### BOX# 514

PRODUCT# 1083795 □ UPC# 661120413165

#### BOX# 515

PRODUCT# 1083796 □ UPC# 661120413172



### 100 ROUND BOXES

#### BOX# 1001

PRODUCT# 1083797 □ UPC# 661120413189

#### BOX# 1003

PRODUCT# 1083794 □ UPC# 661120413196

#### BOX# 1005

PRODUCT# 1083799 □ UPC# 661120413202

#### BOX# 1007

PRODUCT# 1083800 □ UPC# 661120413219

#### BOX# 1008

PRODUCT# 1083798 □ UPC# 661120413226

#### BOX# 1009

PRODUCT# 1083801 □ UPC# 661120413233

VISIT [FRANKFORDARSENAL.COM](http://FRANKFORDARSENAL.COM) FOR COMPLETE LIST OF COMPATIBLE CALIBERS.







***TIPTON***<sup>TM</sup>

**2022**

**RETURNING  
PRODUCTS**

## STANDING ULTRA GUN VISE

PRODUCT: 1094247    UPC: 661120418078

- Ultra Gun Vise modular chassis included
- Free-standing, 4-leg system removes the need for a table or bench
- Oversized levers for easy leg deployment
- 35" height for optimal comfort while working
- Lightweight - weighs approximately 20 lbs
- Built-in bottle opener
- Makes cleaning convenient in the field or on the range

### ULTRA GUN VISE MODULES

- Non-marring, glass-filled nylon vise/clamp construction
- Ball and socket articulating clamp pads allow adaptation to any firearm's surface
- Front and rear clamps are both height and length adjustable
- Mountable directly to horizontal rails
- Removable accessory/tool trays

Patents: [www.aob.com/patents](http://www.aob.com/patents)

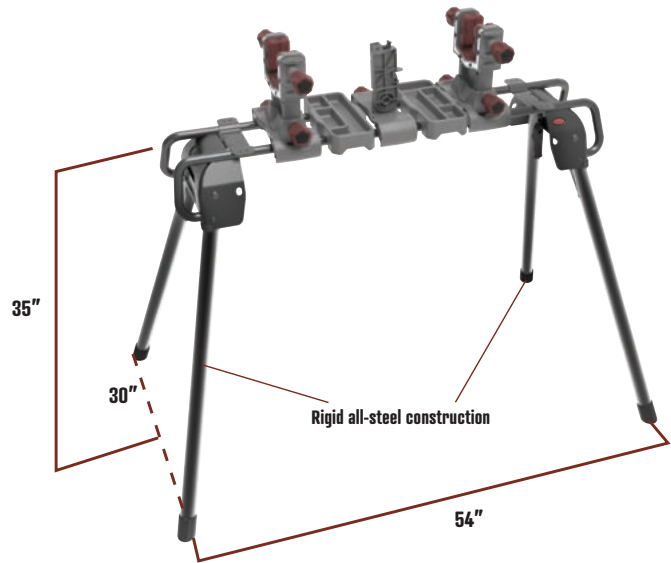

## UNIVERSAL GUN MAINTENANCE STAND

PRODUCT: 1093522    UPC: 661120418085

- Free-standing, 4-leg system removes the need for a table or bench
- Oversized levers for easy leg deployment
- 35" height for optimal comfort while working
- Lightweight - weighs approximately 20 lbs
- Built-in bottle opener
- Makes cleaning convenient in the field or on the range



## ULTRA GUN VISE

PRODUCT: 110011    UPC: 661120100119

- Non-marring, glass-filled nylon vise/clamp construction
- Durable steel tube frame
- Ball and socket articulating clamp pads allow for adaptation to any firearm's surface
- Front and rear clamps are both height and length adjustable
- Four independently-adjustable, non-slip feet
- Mountable directly to benchtop (hardware not included)
- Removable accessory/tool trays

### INTERCHANGEABLE MODULAR DESIGN

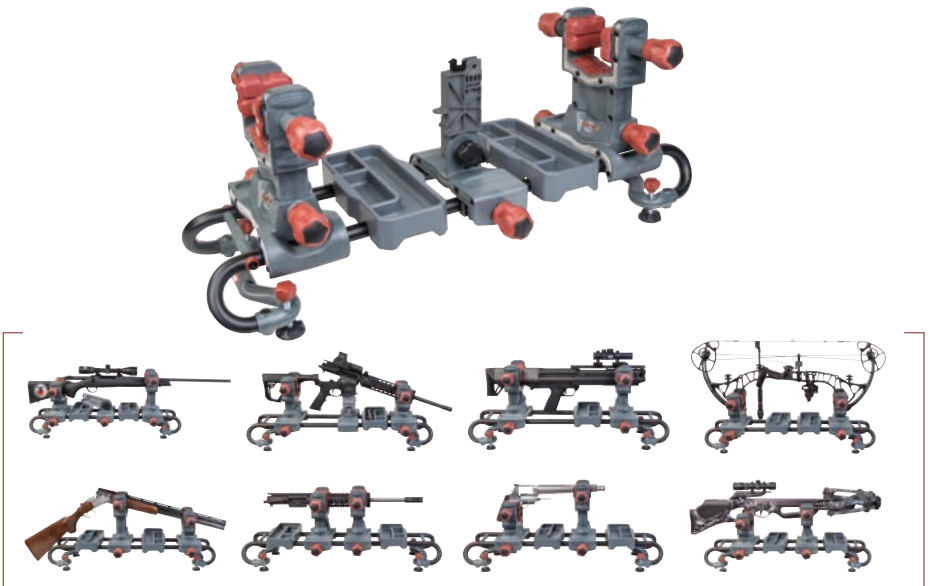

Patents: [www.aob.com/patents](http://www.aob.com/patents)

## BEST GUN VISE

PRODUCT: 181181    UPC: 661120811817

- Non-marring contact surfaces
- Durable polymer construction
- Front and rear base slide on center aluminum rail for optimum length adjustments
- Accommodates multiple firearms and firearm components
- Adjustable rear off-set clamping mechanism
- Four non-slip rubber feet

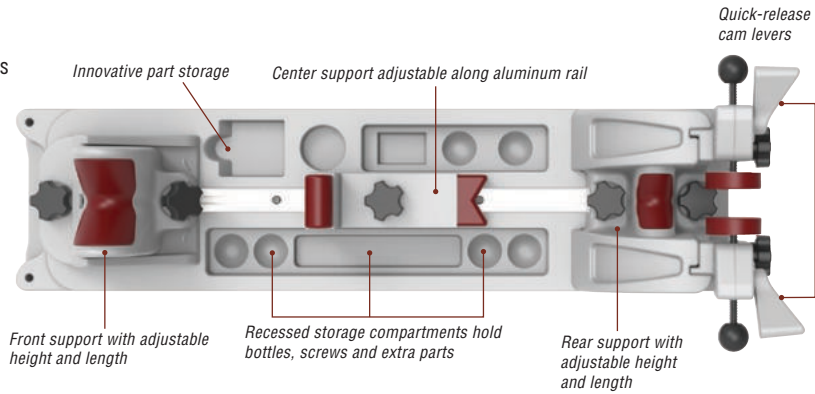

Patents: [www.aob.com/patents](http://www.aob.com/patents)

## GUN VISE

PRODUCT: 782731    UPC: 661120330448

- Non-marring contact surfaces
- Durable polymer construction
- Accommodates multiple firearms and firearm components
- Adjustable rear off-set clamping mechanism
- Four non-slip rubber feet

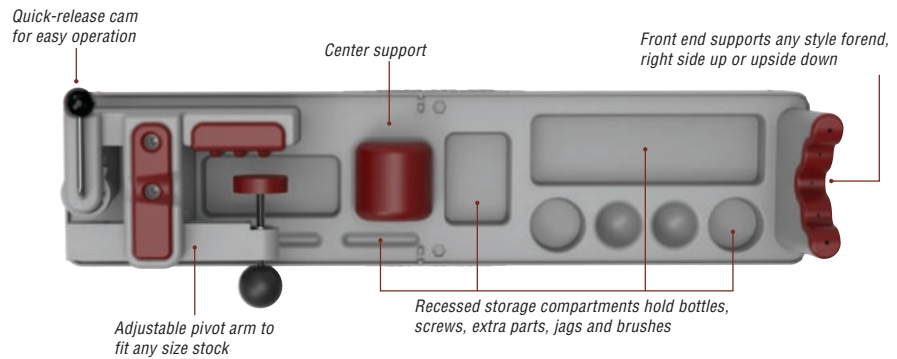

## GUN BUTLER®

PRODUCT: 100333    UPC: 661120003335

- Two removable, non-marring forks to securely hold firearm
- Durable polymer construction
- Convenient recessed storage compartments
- Center-carry handle



# COMPACT RANGE VISE

PRODUCT: 282282    UPC: 661120822820

- Durable, solvent-resistant nylon and polymer construction
- Collapses for easy storage or transport in a range bag
- Six non-slip rubber feet
- Non-marring contact surfaces
- Collapses to 2.75" tall



# 1911 MAG WELL VISE BLOCK

PRODUCT: 558080    UPC: 661120580805

- Non-marring surfaces
- Built-in barrel bushing wrench
- Removable mag well arm
- Solvent-resistant polymer construction
- Mountable directly to benchtop or Tipton Best Gun Vise



# DELUXE CARBON FIBER CLEANING ROD

| PRODUCT # | CALIBER       | LENGTH | UPC          |
|-----------|---------------|--------|--------------|
| 146468R   | .17 - .20 Cal | 26"    | 661120464686 |
| 107486R   | .17 - .20 Cal | 36"    | 661120074861 |
| 658675R   | .22 - .26 Cal | 12"    | 661120586753 |
| 216411R   | .22 - .26 Cal | 26"    | 661120164111 |
| 430886R   | .22 - .26 Cal | 36"    | 661120308867 |
| 182978R   | .22 - .26 Cal | 40"    | 661120829782 |
| 783485R   | .22 - .26 Cal | 44"    | 661120834854 |
| 303569R   | .27 - .45 Cal | 12"    | 661120035695 |
| 376252R   | .27 - .45 Cal | 26"    | 661120762522 |
| 720747R   | .27 - .45 Cal | 36"    | 661120207474 |
| 413662R   | .27 - .45 Cal | 40"    | 661120136620 |
| 509320R   | .27 - .45 Cal | 44"    | 661120093206 |
| 713415R   | Shotgun       | 36"    | 661120134152 |

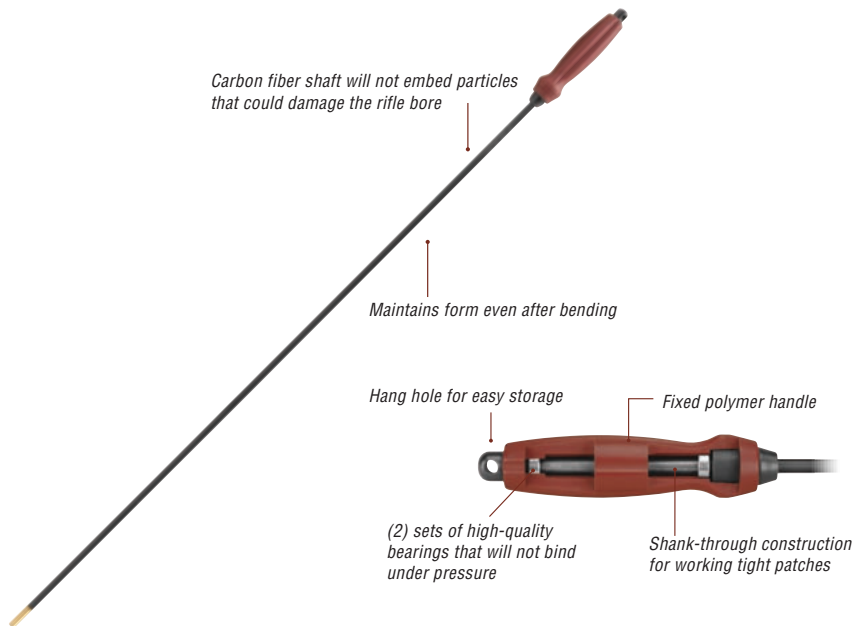

# MAX FORCE™ CLEANING ROD

- PRODUCT: 658539    UPC: 661120525398    .22 Caliber
- PRODUCT: 658540    UPC: 661120585404    .17 - .20 Caliber

- Handle slides freely and is lockable at any point along rod
- 40" usable rod length
- Carbon fiber shaft will not embed particles that could damage the rifle bore
- Highly-durable; no bending or breaking
- Solvent-resistant polymer handle
- .17 - .20 caliber has 5-40 threads
- .22 caliber has 8-32 threads



# NOPE ROPE®

- Durable bore rope with connectable ends for continuous pull-through cleaning
- Included storage case for easy transport and storage

| PRODUCT # | CALIBER           | UPC          |
|-----------|-------------------|--------------|
| 1136050   | 22 Cal. - 2 Pack  | 661120107545 |
| 1136047   | 9mm - 2 Pack      | 661120107514 |
| 1136053   | 12 Gauge - 2 Pack | 661120107576 |
| 1149253   | 22 Cal.           | 661120107255 |
| 1149254   | 6mm               | 661120107262 |
| 1149255   | 6.5mm             | 661120107279 |
| 1149248   | 7mm.              | 661120107200 |
| 1149249   | 30 Cal.           | 661120107217 |
| 1149250   | 9mm               | 661120107224 |
| 1149251   | 40 Cal.           | 661120107231 |
| 1149252   | 45 Cal.           | 661120107248 |
| 1149257   | 20 Gauge          | 661120107996 |
| 1149256   | 12 Gauge          | 661120107989 |



Patents: [www.aob.com/patents](http://www.aob.com/patents)

# ULTRA CLEANING KIT

- PRODUCT: 554400    UPC: 661120544005

- The Ultra Cleaning Kit was designed for the shooter who wants the absolute highest quality cleaning accessories available in one convenient portable kit.

### KIT INCLUDES:

- 3-piece Premium Stainless Steel Rod
- RAPID™ Deluxe Bore Guide Kit
- 13-piece Ultra Jag™ Set with case
- 13-piece Best Bore Brush™ Set with case
- Two general purpose brushes: one nylon and one bronze
- AR-15 bolt carrier and action brushes
- Four polymer cleaning picks
- Carry case with molded foam inserts



FOR USE WITH  
.22 CAL AND  
LARGER RIFLES

## COMPACT PISTOL CLEANING KIT

PRODUCT: 1082252    UPC: 661120412779

- For use on pistol calibers ranging from .22 - .45 caliber
- Collapsible cleaning rod with rotating T-handle
- Stainless steel cleaning rod

**KIT INCLUDES:**

- Cleaning pick
- Ten cotton cleaning patches
- Nylon cleaning brush
- Bronze pistol brushes (.22, 9mm/.357/.38, .40/10mm, .45)
- Nylon jags (.22, 9mm/.357/.38, .40/10mm, .45)
- Two nylon slotted tips



## RIFLE FIELD CLEANING KIT

PRODUCT: 1080201    UPC: 661120412953

- For cleaning rifle calibers ranging from .22-.338. Comes in a resealable package for easy and secure storage and transportation

**INCLUDES:**

- Coated steel cable with felt plugs
- Nylon brush with pick
- Lint-free cloth
- Pre-saturated oil wipe
- Lens cleaning wipe
- Grease packet
- Disposable gloves



## HANDGUN FIELD CLEANING KIT

PRODUCT: 1080202    UPC: 661120412939

- Comes in a resealable package for easy and secure storage and transportation.
- For cleaning pistol calibers ranging from .380-.45.

**INCLUDES:**

- 2 Cotton Swabs
- Nylon brush with pick
- Lint-free cloth
- Pre-saturated oil wipe
- Grease packet
- Disposable gloves



## RAPID™ DELUXE BORE GUIDE KIT

PRODUCT: 777999    UPC: 661120779995

- Ensures proper rod alignment for easier cleaning
- Protects chamber and bore from damage
- Anodized aluminum tube for durability
- Fits most bolt-action rifles and AR-15s

**KIT INCLUDES:**

- Three bore guide tips
- Three brass muzzle guides
- Two pipettes
- Bull Barrel .22cal muzzle guide
- Bore guide solvent port
- Bolt-action collar
- AR-15 collar
- Standard length tube
- Extra long tube
- Plastic molded storage case

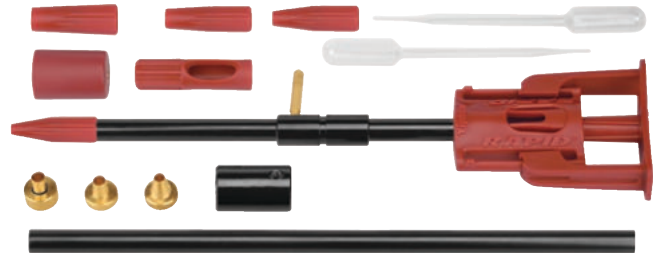

## UNIVERSAL BORE GUIDE KIT

PRODUCT: 777888    UPC: 661120778882

- Anodized aluminum tube for durability
- Fits most bolt-action rifles and AR-15s
- Protects chamber and bore from damage
- Ensures proper rod alignment for easier cleaning

**KIT INCLUDES:**

- Three bore guide tips
- Bore guide solvent port
- Bolt-action collar
- AR-15 collar
- Standard length tube



## ACTION/CHAMBER CLEANING TOOL SET

PRODUCT: 368628    UPC: 661120686286

- Chamber cleaning tool uses a mop to remove carbon and powder residue includes both tools, a small and large rifle chamber mop, 10 swabs and nylon cleaning brush.
- Action cleaning tool utilizes cylindrical swabs to clean and lubricate the locking lug recesses.



**REPLACEMENT SWABS**

| PRODUCT # | MATERIAL                   | UPC          |
|-----------|----------------------------|--------------|
| 115373    | Swabs                      | 661120153733 |
| 324770    | Stainless Steel (Set of 4) | 661120247708 |

# BEST BORE BRUSHES

- All brushes are made from high quality, non-marring bronze
- 20% more bristles than standard brushes

| PRODUCT # | CALIBER               | UPC          |
|-----------|-----------------------|--------------|
| 212009    | .17 Cal - 3 Pack      | 661120120094 |
| 669638    | .20 Cal - 3 Pack      | 661120696384 |
| 140337    | .22 Cal - 3 Pack      | 661120403371 |
| 758284    | .243/6mm - 3-Pack     | 661120582847 |
| 657930    | .25/6.5mm - 3-Pack    | 661120579304 |
| 622858    | .270/7mm - 3-Pack     | 661120228585 |
| 868556    | .30/.32 Cal - 3-Pack  | 661120685562 |
| 427343    | .338/8mm - 3-Pack     | 661120273431 |
| 606367    | .35/9mm - 3-Pack      | 661120063674 |
| 127759    | .375 Cal - 3-Pack     | 661120277590 |
| 317183    | .40/.416 Cal - 3-Pack | 661120171836 |
| 629958    | .44 Cal - 3-Pack      | 661120299585 |
| 211233    | .45 Cal - 3-Pack      | 661120112334 |
| 561865    | .50 Cal - 3-Pack      | 661120618652 |



Wire-through coupler for maximum strength

# BEST BORE BRUSH SET

PRODUCT: 402173      UPC: 661120021735

- Contained in a durable, hinged box with marked cavities.
- Contains .17 - .45 caliber.
- Brushes .22 and larger have 8-32 threads
- .17 and .20 caliber have 5-40 threads.

**INCLUDES:**

- .17
- .20
- .22
- .243/6mm
- .25/6.5mm
- .270/7mm
- .30
- .338/8mm
- .35/9mm
- .375
- .40
- .44
- .45



13-PIECE SET

# ULTRA JAG BEST BORE BRUSH SET

PRODUCT: 444777      UPC: 661120447771

- 26 piece set contains 13 brushes and 13 jags
- Contained in a durable, hinged box with marked cavities.
- Contains .17 - .45 caliber.
- Jags and Brushes .22 and larger
- .17 and .20 caliber have 5-40 threads.

**INCLUDES:**

- .17
- .20
- .22
- .243/6mm
- .25/6.5mm
- .270/7mm
- .30
- .338/8mm
- .35/9mm
- .375
- .40
- .44
- .45

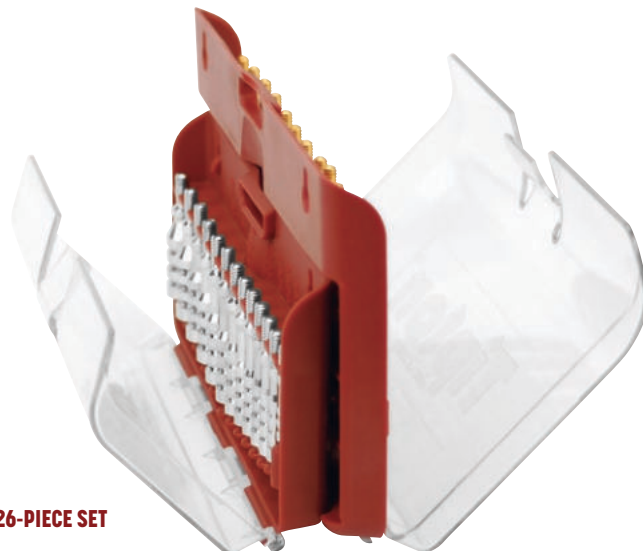

26-PIECE SET



# BORE BRUSH SETS

| PRODUCT # | TYPE                      | UPC          |
|-----------|---------------------------|--------------|
| 168577    | Bronze Rifle 13-Piece Set | 661120685777 |
| 615333    | Nylon Rifle 13-Piece Set  | 661120153337 |

### RIFLE SET

- .17      • .243/6mm      • .30      • .375      • .44
- .20      • .25/6.5mm      • .338/8mm      • .40      • .45
- .22      • .270/7mm      • .5/9mm

| PRODUCT # | TYPE                       | UPC          |
|-----------|----------------------------|--------------|
| 845102    | Bronze Handgun 8-Piece Set | 661120451020 |

### HANDGUN SET

- .22      • .32      • .41/10mm      • .45
- .25/6.5mm      • .38/9mm      • .44      • .476/.480

| PRODUCT # | TYPE                       | UPC          |
|-----------|----------------------------|--------------|
| 671861    | Bronze Shotgun 6-Piece Set | 661120718611 |

### SHOTGUN SET

- .410 GA      • 20 GA      • 12 GA
- 28 GA      • 16 GA      • 10 GA



# BRONZE BORE BRUSHES

- All brushes are made from high quality, non-marring bronze

### RIFLE

| PRODUCT # | CALIBER               | UPC          |
|-----------|-----------------------|--------------|
| 244601    | .17 Cal - 3 Pack      | 661120446019 |
| 244500    | .20 Cal - 3 Pack      | 661120445005 |
| 162429    | .22 Cal - 3 Pack      | 661120624295 |
| 244510    | .243/6mm - 3 Pack     | 661120445104 |
| 244520    | .25/6.5mm - 3 Pack    | 661120445203 |
| 244530    | .270/7mm - 3 Pack     | 661120445302 |
| 244540    | .30/.32 Cal - 3 Pack  | 661120445401 |
| 113901    | .30/.32 Cal - 10 Pack | 661120139010 |
| 244550    | .338/8mm - 3 Pack     | 661120445500 |
| 244560    | .35/9mm - 3 Pack      | 661120445609 |
| 244570    | .375 Cal - 3 Pack     | 661120445708 |
| 244580    | .40/.416 Cal - 3 Pack | 661120445807 |
| 244590    | .44 Cal - 3 Pack      | 661120445906 |
| 244595    | .45 Cal - 3 Pack      | 661120445951 |

### PISTOL

| PRODUCT # | CALIBER            | UPC          |
|-----------|--------------------|--------------|
| 770767    | .22 Cal - 3 Pack   | 661120707677 |
| 507040    | .25 Cal - 3 Pack   | 661120070405 |
| 892661    | .32 Cal - 3 Pack   | 661120926610 |
| 631419    | .38/9mm - 3 Pack   | 661120314165 |
| 223504    | .41/10mm - 3 Pack  | 661120235040 |
| 670133    | .44 Cal - 3 Pack   | 661120701330 |
| 737502    | .45 Cal - 3 Pack   | 661120375029 |
| 141054    | .476/.480 - 3 Pack | 661120410546 |

### SHOTGUN

| PRODUCT # | CALIBER             | UPC          |
|-----------|---------------------|--------------|
| 662575    | 10 Gauge - 3 Pack   | 661120625759 |
| 612735    | 12 Gauge - 3 Pack   | 661120127352 |
| 383231    | 16 Gauge - 3 Pack   | 661120832317 |
| 215223    | 20 Gauge - 3 Pack   | 661120152231 |
| 849144    | 28 Gauge - 3 Pack   | 661120491446 |
| 286637    | .410 Gauge - 3 Pack | 661120866374 |



# BORE MOPS

- 100% Cotton Mops are ultra-absorbent. They hold and carry solvents, lubes and preservatives into your bore and chamber. Great for applying large quantities of modern copper solvents to fouled bores.

| PRODUCT # | CALIBER                       | UPC          |
|-----------|-------------------------------|--------------|
| 312659    | .17 Cal (Case Pack: 5)        | 661120126591 |
| 653568    | .22-.25 Cal (Case Pack: 5)    | 661120535683 |
| 386626    | .338/6.5mm Cal (Case Pack: 5) | 661120866268 |
| 676648    | .40-.45 Cal (Case Pack: 5)    | 661120766483 |
| 657972    | 10-12 GA (Case Pack: 5)       | 661120579724 |
| 681324    | 16-20 GA (Case Pack: 5)       | 661120813248 |
| 242967    | .410 GA (Case Pack: 5)        | 661120429678 |



# BRASS JAG SET

PRODUCT: 749245    UPC: 661120325000

- 13 piece caliber specific solid brass cleaning jags
- Designed to provide a tight fit between the patch and the bore
- Pointed tip keeps the patch centered
- Contained in a durable, hinged box with marked cavities
- Jags have 8-32 threads, .17 and .20 cal have 5-40 threads

**INCLUDES:**

- .17
- .20
- .22
- .243/6mm
- .25/6.5mm
- .270/7mm
- .30
- .338/8mm
- .35/9mm
- .375
- .40
- .44
- .45



# INDIVIDUAL SOLID BRASS JAGS

- Caliber specific individual solid brass cleaning jags
- Designed to provide a tight fit between the patch and the bore
- Pointed tip keeps the patch centered
- Jags have 8-32 threads and .17 and .20 cal have 5-40 threads

| PRODUCT # | CALIBER       | UPC          |
|-----------|---------------|--------------|
| 154070    | .17 Cal       | 661120540700 |
| 589555    | .20 Cal       | 661120895558 |
| 356987    | .22 Cal       | 661120569879 |
| 696435    | .243/6mm Cal  | 661120964353 |
| 584696    | .25/6.5mm Cal | 661120846963 |
| 768059    | .270/7mm Cal  | 661120680598 |
| 193225    | .30/.32 Cal   | 661120932253 |
| 485467    | .338/8mm Cal  | 661120854678 |
| 434832    | .35/9mm Cal   | 661120348320 |
| 272744    | .375 Cal      | 661120727446 |
| 412599    | .40/.416      | 661120125990 |
| 301110    | .44 Cal       | 661120011101 |
| 239013    | .45 Cal       | 661120390138 |
| 505050    | .50 Cal       | 661120050506 |



# ULTRA JAGS

- Jags have 8-32 threads and .17 and .20 jags have 5-40 threads
- Nickel plated solvent-proof coating
- Slotted grooves hold patch & solvent securely for improved cleaning
- Pointed tip keeps the patch centered

| PRODUCT # | CALIBER       | UPC          |
|-----------|---------------|--------------|
| 175543    | .17 Cal       | 661120755432 |
| 589546    | .20 Cal       | 661120895466 |
| 225659    | .22 Cal       | 661120256595 |
| 243865    | .243/6mm Cal  | 661120438656 |
| 255684    | .25/6.5mm Cal | 661120556848 |
| 277555    | .270/7mm Cal  | 661120775553 |
| 303033    | .30/.32 Cal   | 661120030331 |
| 338338    | .338/8mm Cal  | 661120383383 |
| 348359    | .35/9mm Cal   | 661120483595 |
| 375375    | .375 Cal      | 661120753759 |
| 404169    | .40/.416      | 661120041696 |
| 444444    | .44 Cal       | 661120444442 |
| 454545    | .45 Cal       | 661120545453 |



# ULTRA JAG SET

PRODUCT: 500012    UPC: 661120000129

- 13-Piece set contained in a durable, hinged box with marked cavities
- All jags have a nickel plated solvent-proof coating
- Contains .17 - .45 caliber
- Jags have 8-32 threads
- .17 and .20 caliber have 5-40 threads

**INCLUDES:**

- .17
- .20
- .22
- .243/6mm
- .25/6.5mm
- .270/7mm
- .30
- .338/8mm
- .35/9mm
- .375
- .40
- .44
- .45



# NYLON BRUSHES

The core of the Tipton Nylon Bore Brush is a single piece of wire that is looped on the end and a crimped coupler, so it will not scratch your bore. The nylon bristles provide unmatched scrubbing power and are unaffected by modern solvents.

| PRODUCT # | CALIBER               | UPC          |
|-----------|-----------------------|--------------|
| 698306    | .17 Cal - 3 Pack      | 661120983064 |
| 749051    | .22 Cal - 3 Pack      | 661120490517 |
| 176663    | .243/6mm - 3-Pack     | 661120766636 |
| 559632    | .25/6.5mm - 3-Pack    | 661120596325 |
| 887541    | .270/7mm - 3-Pack     | 661120875413 |
| 125012    | .30/.32 Cal - 3-Pack  | 661120250128 |
| 437445    | .338/8mm - 3-Pack     | 661120374459 |
| 105458    | .35/9mm - 3-Pack      | 661120054580 |
| 468709    | .375 Cal - 3-Pack     | 661120687092 |
| 592325    | .40/.416 Cal - 3-Pack | 661120923251 |
| 303351    | .44 Cal - 3-Pack      | 661120033516 |
| 244597    | .45 Cal - 3-Pack      | 661120445975 |



# DOUBLE-ENDED CLEANING BRUSHES

PRODUCT: 654866    UPC: 661120548669

- Small bristles on one end for cleaning small spaces.
- Large bristles on the other end to clean larger items like bolt carriers, cylinders and more.
- Durable nylon bristles will not harm the finish on your firearm.
- Durable bronze bristles will clean tough residue.
- Plastic handle provides maximum reach and flexibility for cleaning.

**INCLUDES:**

- Two (2) nylon brushes
- One (1) bronze brush



## FELT CLEANING PELLETS

- Compressed felt pellets .17-.50 caliber
- Pellets are tough and durable for superior cleaning
- Easier to use than patches
- Each pack includes one caliber-correct brass jag

| PRODUCT # | CALIBER         | PELLET COUNT | UPC          |
|-----------|-----------------|--------------|--------------|
| 1099933   | .17 Cal         | 100 Count    | 661120417095 |
| 1099934   | .20 Cal         | 100 Count    | 661120417101 |
| 1099935   | .22 Cal         | 100 Count    | 661120417118 |
| 1099936   | .243/6mm        | 100 Count    | 661120417125 |
| 1099937   | .25/6.5mm       | 100 Count    | 661120417132 |
| 1099938   | .270/7mm        | 50 Count     | 661120417149 |
| 1099939   | .30/.32 Cal/8mm | 50 Count     | 661120417156 |
| 1099932   | .338            | 50 Count     | 661120417088 |
| 1099940   | .35/9mm/.38 Cal | 50 Count     | 661120417163 |
| 1099941   | .375 Cal        | 50 Count     | 661120417279 |
| 1099942   | .40 Cal         | 50 Count     | 661120417286 |
| 1099943   | .44/.45 Cal     | 50 Count     | 661120417293 |
| 1099944   | .50 Cal         | 50 Count     | 661120417309 |



## GUN CLEANING PICKS

- 🔧 PRODUCT: 549864    UPC: 661120330301    Polymer
- 🔧 PRODUCT: 324770    UPC: 661120247708    Stainless Steel

- Set of 4 picks, each has a different shaped tool at each end.
- Helps you reach the most important, tightest spots in your firearms.



## COMPLETE PELLET PISTOL KIT

- 🔧 PRODUCT: 1099945    UPC: 661120417316

- Kit includes .22, 9mm, .40, .44/.45 caliber-correct jags and pellets
- .22 caliber pellets are 100 count
- 9mm, .40, .44/.45 caliber pellets are 50 count
- Plastic storage case with components

### SINGLE REPLACEMENT PELLET JAGS

| PRODUCT # | CALIBER       | UPC          |
|-----------|---------------|--------------|
| 1100132   | .17 Cal       | 661120417323 |
| 1100133   | .20 Cal       | 661120417347 |
| 1100134   | .22/.264 Cal  | 661120417361 |
| 1100124   | .270/.375 Cal | 661120417415 |
| 1100130   | .40/.50 Cal   | 661120417392 |



## SINGLE REPLACEMENT PELLET JAGS

- Jags to be used with Tipton Felt Cleaning Pellets

| PRODUCT # | CALIBER       | UPC          |
|-----------|---------------|--------------|
| 1100132   | .17 Cal       | 661120417323 |
| 1100133   | .20 Cal       | 661120417347 |
| 1100134   | .22/.264 Cal  | 661120417361 |
| 1100124   | .270/.375 Cal | 661120417415 |
| 1100130   | .40/.50 Cal   | 661120417392 |



## POWER SWABS

- Durable cotton swab construction
- 7.5" flexible bamboo handle
- Quick and effective way to apply solvent or oil
- No mess cleaning
- Fast and easy to use
- Pointed tip swab has heavy-duty tapered end
- General Cleaning tip is heavy-duty and rounded

| PRODUCT # | CALIBER      | PELLET COUNT | UPC          |
|-----------|--------------|--------------|--------------|
| 1099924   | .22 Cal      | 250 Count    | 661120417453 |
| 1099925   | 9mm/.38 Cal  | 175 Count    | 661120417460 |
| 1099926   | .40 Cal      | 100 Count    | 661120417576 |
| 1099927   | .44/.45 Cal  | 100 Count    | 661120417583 |
| 1099928   | .50 Cal      | 100 Count    | 661120417590 |
| 1099929   | Pointed Tip  | 300 Count    | 661120417606 |
| 1099931   | Cleaning Tip | 400 Count    | 661120417620 |

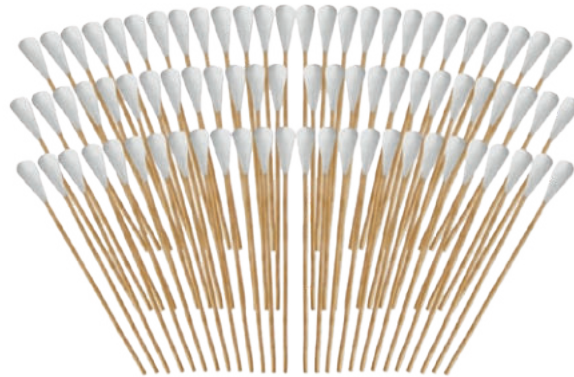

## COMPLETE PISTOL POWER SWAB KIT

 PRODUCT: 1099930    UPC: 661120417613

- 50 Count of .22, 9mm, .40, .44/.45 caliber swabs
- 100 Count of general cleaning tip swabs
- 100 Count of pointed tip swabs
- Packaged in a convenient plastic storage case



# SHOOTING SWABS

- ★ **PRODUCT: 75754**    **UPC: 661120575542**    **50 Count**
- ★ **PRODUCT: 350379**    **UPC: 661120503798**    **100 Count**

- Wire-handled swabs are perfect for applications of lubes and preservatives. They also work well with solvents to scrub out recesses in receivers, bolt bodies and other hard-to-reach areas. Dozens of uses. 4" long.



# CLEANING PATCHES

- These 100% cotton patches are made to work seamlessly with your Tipton cleaning rods and solvents.

| PRODUCT # | CALIBER                         | UPC          |
|-----------|---------------------------------|--------------|
| 476217    | .17-.22 Cal (100 Pack)          | 661120762171 |
| 359811    | .22-.270 Cal (100 Pack)         | 661120598114 |
| 444068    | .27-.35 Cal (100 Pack)          | 661120440680 |
| 192431    | .35-.50/20 GA (100 Pack)        | 661120924319 |
| 784909    | .45-.58 Black Powder (250 Pack) | 661120849094 |
| 364206    | .35-.50/20 GA (500 Pack)        | 661120642060 |
| 470796    | 10, 12, 16 GA (500 Pack)        | 661120707967 |
| 652376    | .17-.22 Cal (1,000 Pack)        | 661120523765 |
| 618061    | .22-.270 Cal (1,000 Pack)       | 661120180616 |
| 279375    | .27-.35 Cal (1,000 Pack)        | 661120793755 |



# SNAP CAPS

- Allows you to release the tension on the hammer springs when storing your guns.
- Practical use for dry fire training and testing or adjusting trigger pull

## RIFLE

| PRODUCT # | CALIBER                          | UPC          |
|-----------|----------------------------------|--------------|
| 831787    | .22 Rimfire Long Rifle - 10 Pack | 661120317876 |
| 486758    | .22 Rimfire Long Rifle - 25 Pack | 661120867586 |
| 1191897   | 6.5 Creedmoor Snap Cap - 2 Pack  | 661120654810 |
| 415091    | .23 Remington - 2 Pack           | 661120150916 |
| 270693    | .243 Winchester - 2 Pack         | 661120706939 |
| 709600    | .270 Winchester - 2 Pack         | 661120096009 |
| 134402    | .308 Winchester - 2 Pack         | 661120344025 |
| 391320    | .30-06 Springfield - 2 Pack      | 661120913207 |

## REVOLVER

| PRODUCT # | CALIBER                    | UPC          |
|-----------|----------------------------|--------------|
| 321398    | .38 Spec./357 Mag - 6 Pack | 661120213987 |
| 347873    | .44 Mag - 6 Pack           | 661120478737 |
| 612637    | .45 Colt - 6 Pack          | 661120126379 |

## SHOTGUN

| PRODUCT # | CALIBER            | UPC          |
|-----------|--------------------|--------------|
| 280986    | 12 Gauge - 2 Pack  | 661120809869 |
| 191808    | 20 Gauge - 2 Pack  | 661120918080 |
| 358983    | .410 Bore - 2 Pack | 661120589839 |

## PISTOL

| PRODUCT # | CALIBER            | UPC          |
|-----------|--------------------|--------------|
| 647663    | .32 ACP - 5 Pack   | 661120476634 |
| 337377    | .380 ACP - 5 Pack  | 661120373773 |
| 303958    | 9mm Luger - 5 Pack | 661120039587 |
| 745435    | .40 S&W - 5 Pack   | 661120454359 |
| 146331    | .45 ACP - 5 Pack   | 661120463313 |



## ROD RACK

PRODUCT: 100335    UPC: 661120003359

- Accommodates six rods of various sizes
- Two hanging hooks on either end for additional accessories
- Includes mounting holes and screws



## BRASS SLOTTED TIPS

- Four caliber range specific rifle/pistol tips.
- Solid brass is softer than barrel steel so there is no worry of damaging your bore, plus they will last much longer than the typical synthetic plastic tips.



| PRODUCT # | CALIBER                                       | UPC          |
|-----------|---|--------------|
| 554428    | Set of 4 (.22-.29, .30-.35, .35-.44, .45 Cal) | 661120544289 |
| 428953    | .22-.29 Cal                                   | 661120289531 |
| 211422    | .30-.35 Cal                                   | 661120114222 |
| 339005    | Universal Shotgun                             | 661120390053 |

## FLIP-TOP BOTTLES (3-PACK)

PRODUCT: 197624    UPC: 661120976240

- 3 High density polyethylene 4 oz bottles hold solvents, oils and many other liquid product search bottle comes with two caps, one flip-top and one standard.



## 8" PIPETTES (12-PACK)

PRODUCT: 146527    UPC: 661120465270

- All-plastic, disposable "eye droppers" are just the ticket for measuring and transferring liquid products. Great for cold bluing solutions, cutting oils, solvents, preservatives, etc.



## SILICONE CLOTH

PRODUCT: 502260    UPC: 661120022602

- The soft cloth, impregnated with pure silicone, provides the perfect wipe-down for your guns before putting them away.
- Protects metal surfaces from rust and corrosion at extreme temperatures and leaves a shiny, well-preserved appearance.
- Will not evaporate or dry out.
- 12"x13"



## MAINTENANCE MATS

- Padded neoprene construction protects firearm finishes.
- Excess oils and solvents are absorbed into the mat, keeping the surface clean and dry.
- Trace of parts on the mat allows for help keeping track of parts for disassembly and reassembly
- Rolls easily to fit into a range bag.
- Hand washable.

| PRODUCT # | TYPE                      | UPC          |
|-----------|---------------------------|--------------|
| 110008    | Glock Model 11" x 17"     | 661120100089 |
| 558680    | 1911 Model 11" x 17"      | 661120586807 |
| 602557    | Maintenance Mat 12" x 24" | 661120025573 |
| 110009    | Maintenance Mat 11" x 17" | 661120100096 |







2023

NEW  
PRODUCTS



# F.A.T. WRENCH®

## FIREARM ACCURIZING TORQUE

PRODUCT: 4001002

UPC: 661120746980

- TORQUE ADJUSTMENT RANGE OF 10-65 IN-LBS FOR A WIDE VARIETY OF GUNSMITHING TASKS
- 10 BITS ARE COATED IN BLACK PHOSPHATE TO PREVENT RUST
- MOLDED CASE ORGANIZES WRENCH AND BITS
- TEXTURED RUBBER HANDLE FOR ENHANCED COMFORT AND GRIP

### INCLUDED INTERCHANGEABLE BITS:

- HEX (X3):** 5/32"-3/32"
- TORX (X2):** TT15-TT20
- FLAT (X3):** Precision Hollow Ground Bits
- BIT EXTENSION:** HEX Adapt.
- SPECIALTY (X1):** Leupold Scope Base

Wheeler's F.A.T. Wrench® (Firearm Accurizing Torque) brings perfect consistency to every screw on your rifle. This amazing, handheld torque wrench lets you apply repeatable, accurate torque settings to scope bases and rings, action screws, and more. This prevents damage to optics and firearms, and decreases the chances of failure in the field. The large range of 10-65 in-lbs. will aid in accurately torquing screws to recommended specifications. The F.A.T. Wrench includes 10 bits built to last, made from phosphate-coated S2 tool steel hardened to 56-58 Rockwell C. The included custom-molded case is perfect for storing the wrench and bits when not in use.



PATS: AOB.COM/PATENTS

# DIGITAL F.A.T. WRENCH®

## FIREARM ACCURIZING TORQUE

PRODUCT: 4001001

UPC: 661120746997

- TORQUE ADJUSTMENT RANGE OF 15-100 IN-LBS FOR A WIDE VARIETY OF GUNSMITHING TASKS
- LCD SCREEN FEATURES LIVE AND PEAK MODES FOR MEASURING TORQUE
- AUDIBLE AND VISUAL INDICATORS
- 10 BITS ARE COATED IN BLACK PHOSPHATE TO PREVENT RUST
- MOLDED CASE ORGANIZES WRENCH AND BITS

### INCLUDED INTERCHANGEABLE BITS:

- HEX (X3):** 5/32"-3/32"
- TORX (X2):** TT15-TT20
- FLAT (X3):** Precision Hollow Ground Bits
- BIT EXTENSION:** HEX Adapt.
- SPECIALTY (X1):** Leupold Scope Base

Wheeler's Digital F.A.T. Wrench (Firearm Accurizing Torque) brings precise torque settings to the handheld torque wrench market. This digital handheld torque wrench lets you apply repeatable, accurate torque settings to scope bases and rings, action screws, and more. The audible and visual indicators let the user know exactly when the desired torque setting has been achieved. The large range of 15-100 in-lbs. will aid in accurately torquing screws to recommended specifications. The Digital F.A.T. Wrench includes 10 bits built to last, made from phosphate-coated S2 tool steel hardened to 56-58 Rockwell C. The included custom-molded case is perfect for storing the wrench and bits when not in use.



PATS: AOB.COM/PATENTS

# 100 PIECE F.A.T. WRENCH®

## SCREWDRIVER SET

PRODUCT: 4001004

UPC: 661120747000

- INCLUDED F.A.T. WRENCH ACHIEVES PERFECT TORQUE WITHOUT CAUSING DAMAGE TO THE FASTENER
- MOLDED CASE ORGANIZES BITS AND DRIVERS
- BITS ARE COATED IN BLACK PHOSPHATE TO PREVENT RUST
- HOLLOW-GROUND FLAT BITS CREATE PRECISE FIT TO PREVENT DAMAGE TO SCREWS AND FIREARMS

### INCLUDED INTERCHANGEABLE BITS:

- HEX (X26):** 0.05"-3/8", 1.5-10mm
- TORX (X13):** T5-T10, TT15-TT40
- FLAT (X28):** Precision Hollow Ground Bits
- PHILLIPS (X5):** PH0-PH3, PH2 Long
- NUT DRIVER (X15):** 3/16"-1/2", 5-12mm
- SQUARE (X3):** 1-3
- PIN (X4):** 0.062"-0.125"
- SPECIALTY (X1):** Leupold Scope Base
- BIT EXTENSION:** HEX Adapt. / 1/4" Drive

Take gunsmithing to the next level with the Wheeler 100 Piece Professional F.A.T. Wrench Screwdriver Set. The combination of our iconic F.A.T. Wrench with 98 screwdriver bits and adapters make this set a gunsmith's dream. With a torque range of 10-65 in-lbs, the F.A.T. Wrench is ideal for a variety of fastening jobs. Both the F.A.T. Wrench and the 1/4" driver handle feature a texturized rubber grip to create a comfortable and secure hold.



PATS: AOB.COM/PATENTS

# 100 PIECE PROFESSIONAL SCREWDRIVER SET

PRODUCT: 4001003

UPC: 661120747017

- INCLUDES SHORT AND EXTENDED DRIVERS WITH TEXTURED RUBBER HANDLES FOR ENHANCED GRIP AND COMFORT
- MOLDED CASE ORGANIZES BITS AND DRIVERS
- BITS ARE COATED IN BLACK PHOSPHATE TO PREVENT RUST

## INCLUDED INTERCHANGEABLE BITS:

**HEX (X26):** 0.05"-3/8", 1.5-10mm  
**TORX (X13):** T5-T10, TT15-TT40  
**FLAT (X28):** Precision Hollow Ground Bits  
**PHILLIPS (X5):** PH0-PH3, PH2 Long  
**NUT DRIVER (X15):** 3/16"-1/2", 5-12mm  
**SQUARE (X3):** 1-3  
**PIN (X4):** 0.062"-0.125"  
**SPECIALTY (X1):** Leupold Scope Base  
**BIT EXTENSION:** HEX Adapt. / 1/4" Drive



Look no further for the ultimate screwdriver set. The Wheeler 100 Piece Professional Screwdriver Set is the perfect addition to any tool box or work bench. Our largest bit assortment includes SAE/Metric nut drivers, hollow-ground flats, Phillips, Torx, SAE/Metric Hex bits, and more. Short and extended driver handles allow for multiple applications, while their textured rubber handles create a comfortable, secure grip. The entire kit is organized in a custom molded case so the perfect bit is easy to find.

PATS: AOB.COM/PATENTS

# 89 PIECE PROFESSIONAL GUNSMITHING SCREWDRIVER SET

PRODUCT: 4001008

UPC: 661120747055

- HOLLOW-GROUND FLAT BITS CREATE PRECISE FIT TO PREVENT DAMAGE TO SCREWS AND FIREARMS
- INCLUDES SHORT AND EXTENDED DRIVERS WITH TEXTURED RUBBER HANDLES FOR ENHANCED COMFORT AND GRIP
- BITS ARE COATED IN BLACK PHOSPHATE TO PREVENT RUST

## INCLUDED INTERCHANGEABLE BITS:

**HEX (X8):** 1/16"- 3/16"  
**TORX (X3):** T10-TT20  
**FLAT (X54):** Precision Hollow Ground Bits  
**PHILLIPS (X4):** PH0-PH3, PH2 Long  
**PIN (X4):** 0.062"-0.125"  
**SPECIALTY (X10):** Redfield / Ruger / Mauser / Millet / M1 / S&W Rebound / Glock / 1911 / Leupold Scope Base / Ruger-Weaver  
**BIT EXTENSION:** HEX Adapt. / 1/4" Drive



The last screwdriver set you'll ever need, the Wheeler 89 Piece Professional Gunsmithing Screwdriver Set has it all. Unlike other screwdriver suppliers, Wheeler's engineers measured the screws on over one hundred modern and antique firearms to make sure that we offered bits for every situation. Whether you are working on a Browning® Superposed, a Remington® 700, a Smith & Wesson® revolver or a Colt® single action, you will find that there is a bit to fit every screw on your gun.

PATS: AOB.COM/PATENTS

# 65 PIECE HEX/TORX SCREWDRIVER SET

PRODUCT: 4001007

UPC: 661120747048

- INCLUDES PRECISION MICRO-DRIVER FOR EYEGASSES, KNIFE CLIPS, OR OTHER SMALL FASTENERS
- MOLDED CASE ORGANIZES BITS AND DRIVERS
- BITS ARE COATED IN BLACK PHOSPHATE TO PREVENT RUST
- TEXTURED RUBBER HANDLE ENHANCES GRIP AND COMFORT

## INCLUDED INTERCHANGEABLE BITS:

**HEX (X32):** 0.028"-3/8", 0.7-10mm  
**TORX (X18):** T1-T10, TT15-TT30  
**FLAT (X6):** Precision Hollow Ground Bits  
**PHILLIPS (X5):** PH00-PH3  
**SPECIALTY (X1):** Leupold Scope Base



The Wheeler® 65 Piece Hex/Torx Screwdriver Set features a full assortment of SAE/Metric Hex and Torx bits. With a textured rubber grip, the 1/4" driver handle provides a comfortable and secure hold while tightening fasteners. The magnetized tip makes changing bits fast and easy. Also included is the 4mm Precision Micro-Driver, perfect for smaller jobs. The sturdy, molded case keeps the bits organized and protected.

PATS: AOB.COM/PATENTS

# 43 PIECE GUNSMITHING SCREWDRIVER SET

PRODUCT: 4001006      UPC: 661120747031

- HOLLOW-GROUND FLAT BITS CREATE PRECISE FIT TO PREVENT DAMAGE TO SCREWS AND FIREARMS
- TEXTURED RUBBER HANDLES FOR ENHANCED COMFORT AND GRIP
- MOLDED CASE ORGANIZES BITS AND DRIVERS
- BITS ARE COATED IN BLACK PHOSPHATE TO PREVENT RUST

### INCLUDED INTERCHANGEABLE BITS:

- HEX (X10):** 1/16"-1/4"
- TORX (X5):** T10, TT15-TT30
- FLAT (X20):** Precision Hollow Ground Bits
- PHILLIPS (X4):** PH0-PH3
- BIT EXTENSION:** HEX Adapt.

Screwdrivers are one of the most important and most used gunsmithing tools. Wheeler's 43 Piece Gunsmithing Screwdriver Set belongs on every gunsmithing bench. Unlike other screwdriver suppliers, Wheeler's engineers measured the screws on over one hundred modern and antique firearms to make sure that we offered bits for every situation. Whether you are working on a Browning® Superposed, a Remington® 700, a Smith & Wesson® revolver or a Colt® single action, you will find that there is a bit to fit every screw on your gun.



PATS: AOB.COM/PATENTS

# 36 PIECE SPACESAVER SCREWDRIVER SET

PRODUCT: 4001005      UPC: 661120747024

- CONVENIENT COMPACT SIZE IS PERFECT FOR STORAGE IN RANGE BAGS, VEHICLES, ETC
- MOLDED CASE ORGANIZES BITS AND DRIVER
- BITS ARE COATED IN BLACK PHOSPHATE TO PREVENT RUST

### INCLUDED INTERCHANGEABLE BITS:

- HEX (X16):** 1/16"-3/16", 1.5-6mm
- TORX (X8):** T6-T10, TT15-TT25
- FLAT (X6):** Precision Hollow Ground Bits
- PHILLIPS (X4):** PH0-PH3

Small but mighty, the Wheeler 36 Piece Spacesaver Screwdriver Set provides a convenient assortment of SAE and Metric Hex, Torx, Phillips, and Flat bits, perfect for common household tasks. The 1/4" drive handle features a textured rubber grip for a secure hold and a magnetized tip for easily changing bits.



PATS: AOB.COM/PATENTS

# F.A.T. STIX™ FIREARM ACCURIZING TORQUE

PRODUCT: 1136022      UPC: 661120107798

- PRESET TORQUE LIMITERS ARE QUICK AND CONVENIENT WITH NO ADJUSTMENTS REQUIRED
- ACCURATELY TIGHTENS TO DESIRED SPECIFICATION, PREVENTING DAMAGE AND STRIPPED SCREWS
- REVERSIBLE DESIGN ALLOWS FOR TIGHTENING AND LOOSENING FASTENERS WITHOUT DAMAGING THE LIMITER
- SOFT CARRY CASE ORGANIZES THE KIT AND IS IDEAL FOR PORTABILITY

Whether in the garage or on the range, tightening to the correct torque value can be the difference between success and failure. The Wheeler F.A.T. Stix set features 15, 25, 35, 45, and 65 in-lbs torque limiters to cover all of the most common applications. This set also includes 12 common bits, a 1/2" socket, and a 1/4" drive bit extension. The ergonomic T-handle design is comfortable and easy to use for a variety of tasks. The convenient carry case makes F.A.T. Stix the perfect tool for on-the-go.



PATS: AOB.COM/PATENTS

# F.A.T. STIX™ LIMITER

|                  |                 |                   |
|------------------|-----------------|-------------------|
| PRODUCT: 1192764 | <b>10 IN-LB</b> | UPC: 661120747147 |
| PRODUCT: 1192765 | <b>15 IN-LB</b> | UPC: 661120747154 |
| PRODUCT: 1192766 | <b>20 IN-LB</b> | UPC: 661120747161 |
| PRODUCT: 1192767 | <b>25 IN-LB</b> | UPC: 661120747178 |
| PRODUCT: 1192768 | <b>30 IN-LB</b> | UPC: 661120747185 |
| PRODUCT: 1192769 | <b>35 IN-LB</b> | UPC: 661120747192 |
| PRODUCT: 1192770 | <b>40 IN-LB</b> | UPC: 661120747208 |
| PRODUCT: 1192771 | <b>45 IN-LB</b> | UPC: 661120747215 |
| PRODUCT: 1192772 | <b>50 IN-LB</b> | UPC: 661120747222 |
| PRODUCT: 1192773 | <b>55 IN-LB</b> | UPC: 661120747239 |
| PRODUCT: 1192774 | <b>60 IN-LB</b> | UPC: 661120747246 |
| PRODUCT: 1192775 | <b>65 IN-LB</b> | UPC: 661120747253 |

PATS: AOB.COM/PATENTS

- PRESET TORQUE LIMITERS ARE QUICK AND CONVENIENT WITH NO ADJUSTMENTS REQUIRED
- ACCURATELY TIGHTENS TO DESIRED SPECIFICATION, PREVENTING DAMAGE AND STRIPPED SCREWS
- MULTIPLE OPTIONS TO FIT A VARIETY OF JOBS

Take the guess work out of torquing gear on the go. The Wheeler F.A.T. Stix Limiters are preset to specific torque values, allowing the user to easily grab the right tool for the job. Accurate within +/-5%, F.A.T. Stix ensure a loose or stripped screw doesn't ruin your day.



# SPORTER RINGS WEAVER®/PICATINNY SCOPE RINGS

|                  |                  |                   |
|------------------|------------------|-------------------|
| PRODUCT: 1133753 | <b>34mm LOW</b>  | UPC: 661120107866 |
| PRODUCT: 1133754 | <b>34mm MED</b>  | UPC: 661120107873 |
| PRODUCT: 1133755 | <b>34mm HIGH</b> | UPC: 661120107880 |
| PRODUCT: 1133750 | <b>30mm LOW</b>  | UPC: 661120107835 |
| PRODUCT: 1133751 | <b>30mm MED</b>  | UPC: 661120107842 |
| PRODUCT: 1133752 | <b>30mm HIGH</b> | UPC: 661120107859 |
| PRODUCT: 1133747 | <b>1" LOW</b>    | UPC: 661120107804 |
| PRODUCT: 1133748 | <b>1" MED</b>    | UPC: 661120107811 |
| PRODUCT: 1133749 | <b>1" HIGH</b>   | UPC: 661120107828 |

- REVERSIBLE LUG CREATES SECURE INTERCHANGEABLE FIT TO WEAVER AND PICATINNY RAILS
- LIGHTWEIGHT 6061 ALUMINUM CONSTRUCTION FOR DURABILITY
- OFFSET SCREWS FOR EASY ADJUSTMENTS
- AVAILABLE IN MULTIPLE HEIGHTS
- RESEALABLE PACKAGING ALLOWS FOR STORAGE AND EASILY TESTING FIT

The Wheeler Weaver®/Picatinny Rings change the scope ring game. These revolutionary rings feature an easily adjustable base for conversion from Weaver to Pic Rail compatibility and back again. The durable 6061 aluminum construction will last through all your hunts and competitions. Four offset screws securely hold your scope in place.

PATS: AOB.COM/PATENTS

\*WEAVER® IS A TRADEMARK OF VISTA OUTDOOR OPERATIONS LLC.

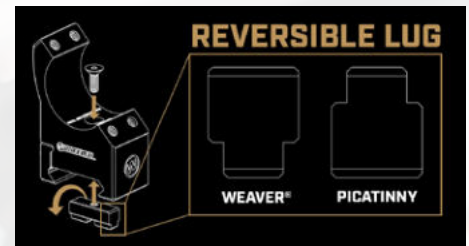

# ULTRA SCOPE MOUNTING KIT

PRODUCT: 4001009      UPC: 661120747130

- PRECISION RETICLE LEVELING SYSTEM ENSURES BOTH THE GUN AND SCOPE ARE LEVEL
- F.A.T. WRENCH AND BITS TORQUE FASTENERS TO MANUFACTURER SPECIFICATIONS
- PROFESSIONAL LASER BORE SIGHT ALLOWS FOR RETICLE CALIBRATION
- STORAGE CASE ORGANIZES AND PROTECTS CONTENTS

The Wheeler® Ultra Scope Mounting Kit puts all the best scope mounting accessories into one perfect package. With this kit you can level your rifle and scope, mount your scope to the rifle, and bore sight your scope with precision and accuracy. The Ultra Scope Mounting Kit even provides a lens pen and thread locker to keep your scope clean and your optics secure on even the largest caliber guns. Includes a heavy duty carry case to keep components organized and secured.

PATS: AOB.COM/PATENTS





2023

RETURNING  
PRODUCTS

# AR ARMORER'S ULTRA KIT

PRODUCT: 156559 UPC: 661120565598

**KIT INCLUDES:**

- AR-15 ARMORER'S VISE
- AR-15 COMBO TOOL
- TORQUE WRENCH
- UPPER VISE BLOCK WITH GAS TUBE ALIGNMENT OIL
- AR-15 MAINTENANCE MAT
- AR-15 ROLL PIN INSTALL TOOL KIT
- ADJUSTABLE RECEIVER LINK
- MAG/UPPER RECEIVER BRUSH
- DOUBLE-ENDED GENERAL CLEANING BRUSH
- AR-15 BORE GUIDE
- .22 CAL BORE BRUSH
- BOLT CARRIER BRUSH
- CHAMBER BRUSH
- NYLON BRUSH HANDLE
- CLEANING PICK SET
- CUSTOM CARRY CASE
- AR FRONT SIGHT TOOL
- DELTA RING TOOL
- STRAP WRENCH
- AR-15 BENCH BLOCK
- PIVOT & ROLL PIN INSTALL TOOL



The Wheeler® AR Armorer's Ultra Kit contains every premium tool needed to build and maintain your AR-15 rifle.

# AR ARMORER'S PROFESSIONAL KIT

PRODUCT: 156555 UPC: 661120565550

**KIT INCLUDES:**

- AR-15 ARMORER'S VISE
- AR-15 COMBO TOOL
- TORQUE WRENCH
- UPPER VISE BLOCK WITH GAS TUBE ALIGNMENT OIL
- AR-15 MAINTENANCE MAT
- PIVOT & ROLL PIN INSTALL TOOL
- ADJUSTABLE RECEIVER LINK
- MAG/UPPER RECEIVER BRUSH
- DOUBLE-ENDED GENERAL CLEANING BRUSH
- AR-15 BORE GUIDE
- .22 CAL BORE BRUSH
- BOLT CARRIER BRUSH
- CHAMBER BRUSH
- NYLON BRUSH HANDLE
- CLEANING PICK SET
- CUSTOM CARRY CASE
- AR FRONT SIGHT TOOL
- DELTA RING TOOL
- STRAP WRENCH



The Wheeler® AR Armorer's Professional Kit contains premium tools needed to build and maintain your AR-15 rifle.

# AR ARMORER'S ESSENTIALS KIT

PRODUCT: 156111 UPC: 661120561118

**KIT INCLUDES:**

- AR-15 COMBO TOOL
- TORQUE WRENCH
- UPPER VISE BLOCK WITH GAS TUBE ALIGNMENT OIL
- AR-15 MAINTENANCE MAT
- PIVOT & ROLL PIN INSTALL TOOL
- AR-15 MAG WELL VISE BLOCK
- ADJUSTABLE RECEIVER LINK
- CUSTOM CARRY CASE



The Wheeler® AR Armorer's Essentials Kit contains essential tools an armorer needs to build or maintain AR-15/M16 rifles. Each tool is designed with application specific features to perform specific functions with precision and ease.

# UPPER RECEIVER ACTION ROD

PRODUCT: 1100182

UPC: 661120418061

- WORKS ON ALL AR-15'S WITH STANDARD BARREL EXTENSIONS
- LOCKS INTO BARREL EXTENSION
- TORQUE BARREL NUTS WITHOUT RISKING DAMAGE TO UPPER
- NO REMOVAL OF OPTICS OR SIGHTS REQUIRED
- WORK ON YOUR UPPER FROM MULTIPLE ANGLES WITHOUT SLIPPING IN VICE JAWS
- GAS PORT ALIGNMENT TOOL

The Wheeler® Upper Receiver action rod reduces stress on upper receiver during barrel installation or removal.

PATS: AOB.COM/PATENTS



# PROFESSIONAL ARMORER'S WRENCH

PRODUCT: 1099561

UPC: 661120418047

- STEEL CONSTRUCTION
- OVERMOLDED RUBBER HANDLE W/ TORQUE SPECS
- MIL-SPEC BARREL NUT WRENCH
- FREE FLOAT BARREL NUT WRENCH
- BUFFER TUBE CASTLE NUT WRENCH
- A2 FLASH HIDER WRENCH
- RIFLE RECEIVER EXTENSION WRENCH
- 1/2" TORQUE WRENCH COMPATIBLE

The Wheeler® Professional Armorer's Wrench is designed to be the last wrench you'll need for building your perfect rifle. This tool is what every gunsmith or armorer needs to be able to build or repair their AR-15.



# AR-15 MAINTENANCE MAT 47" X 20"

PRODUCT: 156824

UPC: 661120568247

- MADE OF PADDED NEOPRENE
- ABSORBS OILS AND SOLVENTS
- NON-SLIP RUBBER BACKING
- ROLLS UP FOR EASY STORAGE
- HAND WASHABLE

The Wheeler® AR-15 Maintenance Mat is perfect for any AR-15 owner. It features a screen printed expanded view of an AR-15 Carbine to easily identify the parts of your rifle. The Mat is made of a dark gray non-marring padded neoprene material with a durable non-skid rubber backing to protect firearm finishes while helping to keep track of small parts. Excess oils and solvents are absorbed into the mat, keeping the surface clean and dry.





# AR TRIGGER GUARD INSTALL TOOL

PRODUCT: 710907

UPC: 661120109075

- INSTALL OR CHANGE TRIGGER GUARDS QUICKLY AND EASILY
- INCLUDES INSTALL PIN AND AN UNINSTALL PIN
- PINS CONVENIENTLY STORE IN THE FRAME
- MADE OF DURABLE ALUMINUM WITH A MIL-SPEC ANODIZED SURFACE FINISH

The Wheeler® AR Trigger Guard Install Tool is designed to make quick work of installing and removing trigger guard pins.

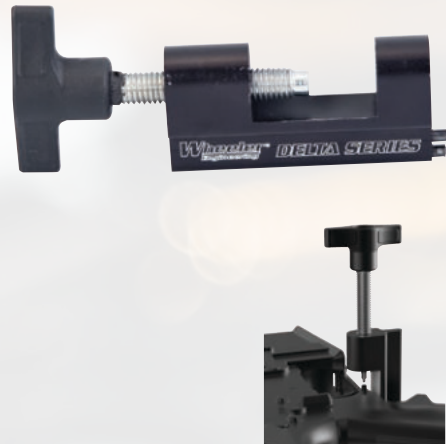

# AR ARMORER'S VISE

PRODUCT: 156224

UPC: 661120562245

- NON-SLIP RUBBER FEET CAN BE REMOVED FOR PERMANENT BENCHTOP MOUNTING
- FOREND SUPPORT CAN ACCOMMODATE DIAMETERS UP TO 2.3"
- RIGID STEEL BASE FEATURES DEPRESSIONS FOR HOLDING SPARE PARTS OR TOOLS
- FRONT AND REAR SUPPORTS ROTATE TO MULTIPLE POSITIONS AND ARE REVERSIBLE FOR MAXIMUM CUSTOMIZATION

The AR-15 platform has become the mainstay of today's Modern Sporting Rifle market. The popularity and modularity of this platform has created the need for specific tools that allow users to build, maintain and reconfigure AR's. The Wheeler® Armorer's Vise provides users an ideal foundation for all AR tasks.

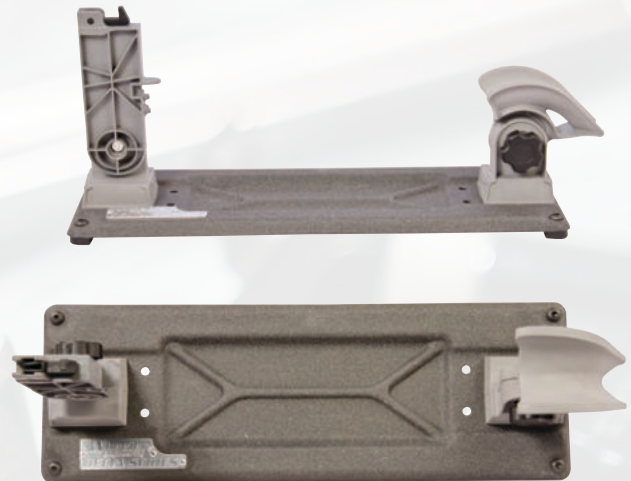

# MAG WELL VISE BLOCK

PRODUCT: 156211

**AR-15**

UPC: 661120562245

PRODUCT: 146200

**AR-10/LR VAR.**

UPC: 661120562245

- BENCHTOP MOUNTABLE WITH INCLUDED FASTENERS
- LOCKS INTO PLACE USING MAGAZINE LOCK-ON RECEIVER
- BUILT-IN HAMMER STOP PREVENTS DAMAGE TO LOWER RECEIVER
- SOLVENT-RESISTANT POLYMER PROVIDES DURABILITY AND IS NON-MARRING TO SURFACES
- MAG WELL ARM IS REMOVABLE FOR CLAMPING IN A VISE

The Wheeler® AR-15 Mag Well Vise Block is quite possibly the handiest tool an AR-15 owner could ask for. This center support slides into the magazine well and provides a steady base for cleaning or light gunsmithing on your AR-15.

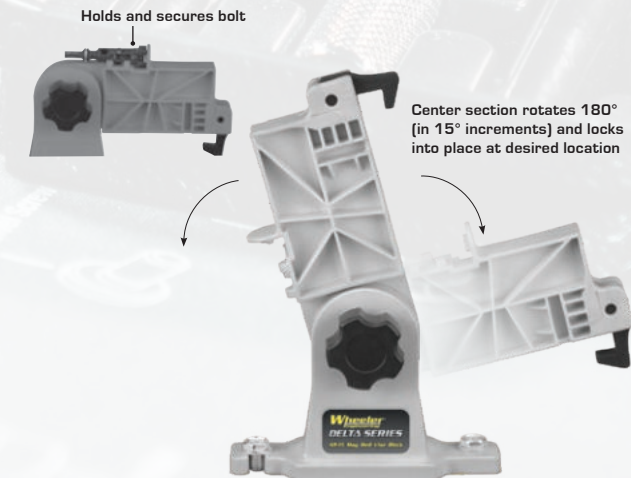

# AR ARMORER'S BENCH BLOCK

PRODUCT: 156945      UPC: 661120569459

- DURABLE NON-MARRING URETHANE MATERIAL TO PROTECT GUN FINISH
- DESIGNED TO ASSIST IN ALL ASPECTS OF AN AR-15 BUILD
- IDEAL FOR CHANGING OR ADJUSTING TRIGGERS
- HOLDS LOWER SECURE FOR ROLL PIN ASSEMBLY
- PERFECT FOR GAS BLOCK PINS

Tired of trying to secure your AR parts while installing a pin, detent or spring? The Wheeler® AR-15 Bench Block is the answer! Specifically designed for AR-15 assembly and disassembly, the AR-15 Bench Block is the perfect tool. It securely holds the upper receiver, lower receiver, front sight and charging handle during assembly, disassembly and maintenance.

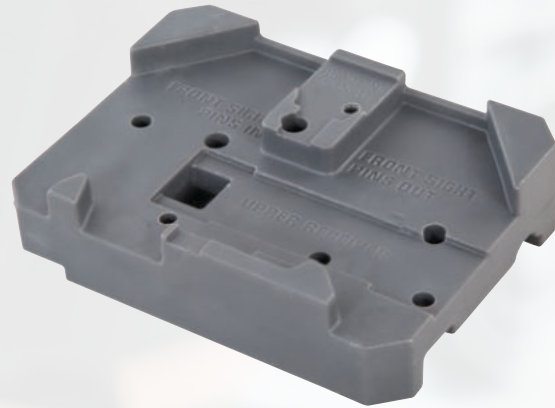

# AR CARBON MULTI-SCRAPER

PRODUCT: 1078195      UPC: 661120411352

- CLEANS 11 SURFACES OF THE BOLT CARRIER GROUP
- FITS INSIDE AR PISTOL GRIPS
- COATED STAINLESS STEEL CONSTRUCTION

Keep carbon build-up from effecting your next shot with the Wheeler® AR Carbon Multi-Scraper. This stainless steel coated, compact tool is made to clean 11 vital surfaces of the bolt carrier group. Keep this tool on your bench or take advantage of its convenient size by storing it inside your rifle's pistol grip. This is the perfect tool for getting back to shooting quickly and effectively.



# COMPACT AR MULTI-TOOL

PRODUCT: 1078948      UPC: 661120412823

- MULTI-TOOL DESIGN TO PERFORM MANY FUNCTIONS IN THE FIELD
- SATIN-FINISH, STAINLESS STEEL CONSTRUCTION
- FEATURES AN AR CARBON MULTI-SCRAPER TOOL, 5/64" HEX, 7/64" HEX, 1/8" HEX, PIVOT AND TAKEDOWN PUNCH, #2 PHILLIPS, BOLT WAIST SCRAPER, INTERIOR BCG SCRAPER, T10 TORX, T15 TORX, T20 TORX, A2 FRONT SIGHT TOOL, 3/16" FLAT, 3/4" WRENCH, 1/2" WRENCH AND A CASTLE NUT WRENCH

There is no need for a tool box at the range when you have the Wheeler® Compact AR Multi-Tool. With a satin finish and stainless steel construction, this tool is not only handy, but durable. The multi-tool design can be used to perform many different functions in the field. When you need to make adjustments, or scrape some carbon build-up, simply reach down and grab this tool out of the included nylon belt sheath and go to work. After you are finished, snap the tool back in and continue shooting.

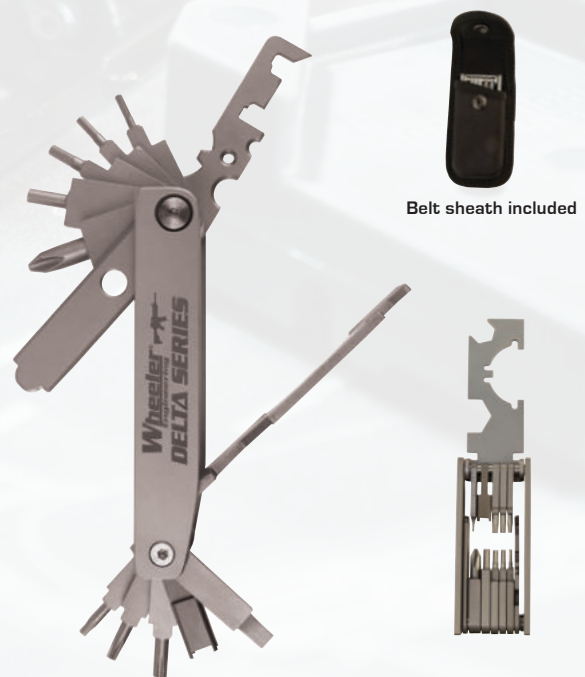

Belt sheath included

# BORE GUIDES

PRODUCT: 156213 **AR-15** UPC: 661120562139

PRODUCT: 156777 **AR-10/LR VAR.** UPC: 661120567776

PRODUCT: 777209 **300 AAC BLK.OUT** UPC: 661120772095

- PREVENTS DAMAGE TO BORE BY ALIGNING CLEANING ROD
- DURABLE ANODIZED FINISH

The Wheeler® AR-15 Bore Guide works well with .223 and .204, while the AR LR/10 Variant works well on .308. The AR-15 300 AAC Blackout Bore Guide works on any 30 caliber, 6.5 or 6.8 AR-15. The AR-15 Bore Guide inner tube diameter is .250". Fit securely in any AR-15 or AR LR/10 variant upper and can be retained in place by closing the dust cover on the upper—engaging a groove in the guide.



# AR BOLT CATCH INSTALL PUNCH KIT

PRODUCT: 710906 UPC: 661120109068

- FLAT ON ONE SIDE FOR PROPER ALIGNMENT
- RUBBER OVER-MOLDED TO PREVENT DAMAGE TO FIREARM
- INCLUDES 2 STEEL PUNCHES
- 1 WITH COUNTER-BORED TIPS TO START ROLL PINS
- 1 WITH INDEXING TIPS TO FINISH ROLL PINS

The Wheeler® Bolt Catch Install Punch Kit starts bolt catch roll pins easily with the starter punch and finishes installation flush with the finishing punch.



# AR DELTA RING TOOL

PRODUCT: 209943 UPC: 661120099437

- CUSTOM FORMED WIRE FITS SECURELY AROUND DELTA RING
- WELDED STEEL BRACKET FOR DURABILITY EVEN WITH STUCK OR BROKEN DELTA RINGS

The Wheeler® AR-15 Delta Ring Tool makes removing mil-spec AR-15 and M16 handguards easy by compressing the Delta Ring with one hand. Its 100% vinyl coating protects the guns finish from damage. The custom formed wire fits securely around Delta Ring. The Delta Ring Tool has a welded steel bracket for durability even with stuck or broken Delta Rings.



# AR PIVOT & ROLL PIN INSTALL TOOL

PRODUCT: 156243 UPC: 661120562436

- COMPATIBLE WITH THE AR-15, M4, OR M16
- FAST AND EFFORTLESS PIVOT SPRING AND DETENT WORK
- ROLL PIN PUNCH AND STARTER FOR ALL LOWER RECEIVER ROLL PINS
- KEY RING FOR STORAGE
- BLACK ELECTRO-COATED STEEL FOR DURABILITY

The Wheeler® AR Pivot & Roll Pin Install Tool is designed for use with the AR-15, M4 or M-16 rifles, making pivot pin spring and detent work fast and effortless. It comes with handy key ring for storage, and is made of black zinc plated steel to stand up to any job.



## AR FRONT SIGHT TOOL

PRODUCT: 156437

UPC: 661120564379

- COMPATIBLE WITH ANY 1/4" HEX DRIVER
- BLACK ZINC-PLATED STEEL FOR DURABILITY

The Wheeler® AR Front Sight Tool is a 4-prong front sight tool designed to install and adjust the A2 front sight found on the AR-15, M16, and M4. It is machined from steel and has a black zinc finish to last for years. The key ring serves as a handle and helps keep the small tool accounted for. Can be used with any 1/4" hex driver.



## AR UPPER VISE BLOCK

PRODUCT: 156444

UPC: 661120564447

- FITS LEFT AND RIGHT-HANDED MIL-SPEC A2 UPPER WITH CARRIER HANDLES
- FITS FLAT TOP RECEIVERS
- MADE OF NON-MARRING, SOLVENT RESISTANT POLYMER MATERIAL
- UPPER SUPPORT ROD WITH INTEGRATED ALIGNMENT ROD ENSURES BARREL NUT IS PROPERLY ALIGNED

The Wheeler® AR Upper Vise Block is the perfect product for torquing a barrel on, removing a stubborn barrel nut or for simple gun maintenance and cleaning. It is made of a non-marring, solvent resistant polymer material which can withstand almost anything you can throw at it.



## AR-15 COMPLETE BRUSH SET

PRODUCT: 156715

UPC: 661120567158

### **KIT INCLUDES:**

- MAGAZINE/UPPER RECEIVER BRUSH WITH MAGAZINE TAKE DOWN TOOL
- BOLT CARRIER BRUSH WITH 8-32 THREADS
- CHAMBER BRUSH WITH 8-32 THREADS
- .22 CAL BORE BRUSH WITH 8-32 THREADS

The Wheeler® AR-15 Complete Brush Set is specifically designed for cleaning your AR-15. The high quality nylon brushes feature an 8 x 32 thread to fit on the included cleaning handle or any 8 x 32 cleaning rod. The brush set has everything you need to clean your rifle, plus everything you need to keep your magazines clean and running reliably.



## AR GAS BLOCK TAPER PIN REMOVAL TOOL

PRODUCT: 1079898

UPC: 661120412793

- WORKS ON A2 FRONT SIGHTS
- WORKS ON SMITH & WESSON SINGLE-TAPER PIN GAS BLOCKS
- WORKS ON DUAL TAPER PINS
- CONSTRUCTED FROM DURABLE TOOL STEEL

Take full control of your custom build with the Wheeler® Gas Block Taper Pin Removal Tool. Whether you have a vise, or just a ball peen hammer, the Support Block paired with the starter and finishing punches makes removing A2 style gas blocks quick and easy. Built with durable tool steel, this is a must-have for any work bench.



# AR-15 ROLL PIN INSTALL TOOL KIT

PRODUCT: 952636

UPC: 661120526360

**KIT INCLUDES:**

- AR BOLT CATCH INSTALL PUNCH KIT
- AR TRIGGER GUARD INSTALL TOOL
- 3 STARTER STEEL PUNCHES (1/16", 5/16", 3/32")
- 3 DRIVER STEEL PUNCHES (1/16", 5/16", 3/32")
- TWO-SIDED HAMMER
- BLOW-MOLDED STORAGE CASE

The Wheeler® AR Roll Pin Install Tool Kit is perfect for installing or removing AR roll pins without marring the firearm. The included Trigger Guard Install Tool makes installing or changing trigger guards quick and easy. The Bolt Catch Install Punch Kit is flat on one side for proper alignment.



# COMPACT AR CLEANING KIT

PRODUCT: 1082251

UPC: 661120412762

**KIT INCLUDES:**

- AR CHAMBER BRUSH
- MULTI-FUNCTION BOLT SCRAPER TOOL
- CLEANING PICK
- COLLAPSIBLE 36" STAINLESS STEEL CLEANING ROD WITH ROTATING T-HANDLE
- THREE STAR CHAMBER CLEANING PADS
- PATCHES FOR .22 AND .30 CAL
- NYLON BRUSHES FOR .22 AND .30 CAL
- JAGS FOR .22 AND .30 CAL

Hold the power to clean your rifle in the palm of your hand with the Wheeler® Compact AR Cleaning Kit. This kit comes in a semi-rigid, zippered carry case and can be used on .22 and .30 caliber rifles. Whether you travel, clean at the range, or like to be organized at home, this kit is the perfect size for storing in small spaces, including a magazine pouch, and durable enough to take anywhere.



# AR COMBO TOOL WITH TORQUE WRENCH

PRODUCT: 156700

UPC: 661120567004

- HARDENED STEEL BARREL NUT PINS
- CUTOUT FOR 3/4" FLASH HIDER
- BUFFER TUBE NUT DRIVER
- CUTOUT FOR FIXED STOCK BUFFER TUBE

Cover most of your AR-15 service needs with a single tool. An innovative layered and laminated stamped steel construction makes the Delta Series® Combo Tool the most durable AR tool available. Additionally, the included Torque wrench in the Combo pack makes this a complete set for many AR maintenance and modification needs.

**AR COMBO TOOL ONLY**

PRODUCT: 156999

UPC: 661120569992



# AR UPPER/PIC RAIL VISE BLOCK

PRODUCT: 156888      UPC: 661120568889

- MULTI-FUNCTION DESIGN HOLDS AR-15 AND MOST AR-10/LR308 UPPERS
- EASILY SECURE ANY PIC RAIL RECEIVER OR HANDGUN
- DURABLE MACHINED ALUMINUM CONSTRUCTION

The Wheeler® AR Upper Pic Rail Vise Block is designed to securely hold AR upper receivers. It will secure AR-15 uppers by engaging the takedown lugs on the bottom of the receivers. By reversing the direction it will secure most AR-10 style uppers in the same manner. The included Pic Rail slot allows any flat top upper or handguard with a pic rail to be securely held in a vice for cleaning or maintenance.



# SCOPE RING ALIGNMENT & LAPPING KITS

|                  |               |                   |
|------------------|---------------|-------------------|
| PRODUCT: 204061  | 1             | UPC: 661120040613 |
| PRODUCT: 633266  | 30MM          | UPC: 661120332664 |
| PRODUCT: 1081035 | 34MM          | UPC: 661120412557 |
| PRODUCT: 305172  | 1" & 30MM     | UPC: 661120051725 |
| PRODUCT: 781366  | 1" ALIGN. BAR | UPC: 661120813668 |

### KIT INCLUDES:

- LAPPING BAR(S)
- LAPPING BAR HANDLE
- ALIGNMENT BARS
- 220 GRIT LAPPING BAR COMPOUND

Aligning and lapping of new rings should become the standard practice whenever a scope is installed on a quality firearm. The alignment bars in this kit provide for perfect alignment of both rings and will also diagnose any misalignment problem, vertical or horizontal, giving you the opportunity to fix the problem before damaging the scope or experiencing frustration at the range.



# RECEIVER LAPPING TOOL

|                  |                |                   |
|------------------|----------------|-------------------|
| PRODUCT: 156757  | AR-15          | UPC: 661120567578 |
| PRODUCT: 1082227 | AR-10/LR VAR.  | UPC: 661120412564 |
| PRODUCT: 342303  | LAP. COMP. KIT | UPC: 661120423034 |

### KIT INCLUDES:

- FLEX DRIVER SHAFT IS COMPATIBLE WITH ELECTRIC DRILL
- 220 GRIT LAPPING COMPOUND
- LAPPING BAR FEATURES STEEL CONSTRUCTION WITH BLACK OXIDE FINISH

Get the perfect fit with the Wheeler® Receiver Lapping Tool. Lapping a receiver ensures a perfectly square and true surface for the barrel to mate against, enhancing accuracy. Honing the surface can produce optimal positioning of barrel nut so ideal torque can be achieved along with proper gas tube hole alignment.



# LAPPING COMPOUNDS REPLACEMENT GRITS

|                 |                 |                   |
|-----------------|-----------------|-------------------|
| PRODUCT: 885040 | <b>220 GRIT</b> | UPC: 661120190578 |
| PRODUCT: 378413 | <b>320 GRIT</b> | UPC: 661120190349 |
| PRODUCT: 395155 | <b>600 GRIT</b> | UPC: 661120090113 |

• REPLACEMENT COMPOUND FOR BORE LAPPING KIT.



# SPACESAVER SCREWDRIVER SET

PRODUCT: 664507      UPC: 661120645078

- DURABLE S2 TOOL STEEL
- DURABLE NO-SLIP OVERMOLDED HANDLE
- MAGNETIC BIT RETENTION IN DRIVER
- CONVENIENT HINGED STORAGE CASE

### INCLUDED INTERCHANGEABLE BITS:

**FLAT:** #1 / #11 / #13 / #15 / #19 / #22 / #25 / #28 / #33 / #39  
**HEX:** 1/16" / 5/64" / 3/32" / 1/8" / 9/64" / 7/64" / 5/32" / 3/16"  
**TORX:** T10 / T15 / T20  
**PHILLIPS:** PH0 / PH1 / PH2 / PH3



# 43 PIECE GUNSMITHING SCREWDRIVER SET

PRODUCT: 954621      UPC: 661120546214

- DURABLE S2 TOOL STEEL
- DURABLE NO-SLIP OVERMOLDED HANDLE
- MAGNETIC BIT RETENTION IN DRIVER
- CONVENIENT HINGED STORAGE CASE

### INCLUDED INTERCHANGEABLE BITS:

**FLAT:** #1 / #3 / #8 / #11 / #12 / #13 / #15 / #16 / #18 / #19  
 #22 / #24 / #25 / #27 / #28 / #31 / #33 / #36 / #39 / #41  
**HEX:** 1/16" / 5/64" / 3/32" / 7/64" / 1/8" / 9/64" / 5/32"  
 3/16" / 7/32" / 1/4"  
**TORX:** T10 / T15 / T20 / T27 / T30  
**PHILLIPS:** PH0 / PH1 / PH2 / PH3  
**SPECIALTY:** LUEPOLD-BUEHLER



# 55 PIECE HEX/TORX SCREWDRIVER SET

PRODUCT: 1081958      UPC: 661120412731

- DURABLE S2 TOOL STEEL
- DURABLE NO-SLIP OVERMOLDED HANDLE
- MAGNETIC BIT RETENTION IN DRIVER
- CONVENIENT HINGED STORAGE CASE

### INCLUDED INTERCHANGEABLE BITS:

**TORX:** T1 / T2 / T3 / T4 / TT5 / TT6 / TT7 / TT8 / TT9 / TT10  
TT15 / TT20 / TT25 / TT30 / TT35 / TT40 / TT45 / TT50

**METRIC HEX (mm):** 0.7 / 0.9 / 1.3 / 1.5 / 2 / 2.5 / 3  
4 / 4.5 / 5 / 5.5 / 6 / 7 / 8 / 10

**SAE HEX (in):** 0.028 / 0.035 / 0.05 / 1/16 / 5/64 / 3/32  
7/64 / 1/8 / 9/64 / 5/32 / 3/16 / 7/32 / 1/4 / 5/16 / 3/8

**OTHER:** PH1 / PH2 / FL14 / FL32

**DRIVER HANDLE:** 1/4" / 4mm



# 72 PIECE GUNSMITHING SCREWDRIVER SET

PRODUCT: 776737      UPC: 661120767374

- 54 HOLLOW-GROUND FLAT BITS
- DURABLE S2 TOOL STEEL
- TWO NO-SLIP OVERMOLDED HANDLES
- CONVENIENT HINGED STORAGE CASE

### INCLUDED INTERCHANGEABLE BITS:

**FLAT:** #1 - #47

**HEX:** 1/16" / 5/64" / 3/32" / 1/8" / 9/64" / 5/32" / 3/16"

**TORX:** T10 / T15 / T20

**PHILLIPS:** PH0 / PH1 / PH2 / PH3



# 89 PIECE PROFESSIONAL GUNSMITHING SCREWDRIVER SET

PRODUCT: 562194      UPC: 661120621942

- 54 HOLLOW-GROUND FLAT BITS
- DURABLE S2 TOOL STEEL
- TWO NO-SLIP OVERMOLDED HANDLES
- 2 1/4" SHAFT EXTENSION
- HEX-TO-SQUARE DRIVE ADAPTER
- CONVENIENT HINGED STORAGE CASE

### INCLUDED INTERCHANGEABLE BITS:

**FLAT:** #1 - #47

**HEX:** 1/16" / 5/64" / 3/32" / 1/8" / 9/64" / 5/32" / 3/16"

**TORX:** T10 / T15 / T20

**PHILLIPS:** PH0 / PH1 / PH2 / PH3

**PIN:** 0.062" / 0.093" / 0.118" / 0.125"

**SPECIALTY:** RUGER-WEAVER / GLOCK / LUEPOLD-BUEHLER / RUGER / MAUSER /  
MILLET / 1911 GRIP / PHILLIPS LONG / REDFIELD / S&W REBOUND





## 21 PIECE EXPANSION SET

PRODUCT: 954671      UPC: 661120546719

- GREAT ADDITION TO THE 72 OR 89 PIECE SCREWDRIVER SETS
- DURABLE S2 TOOL STEEL
- FEATURES PLASTIC STORAGE TRAY THAT FITS PERFECTLY INTO THE CURRENT CASE

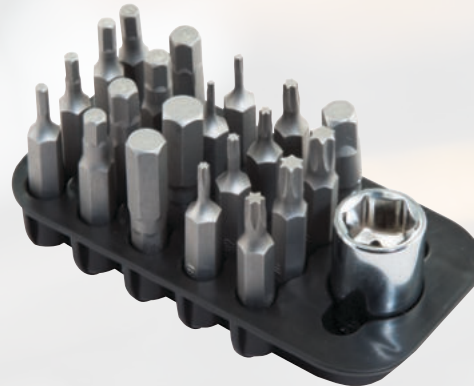

### INCLUDED INTERCHANGEABLE BITS:

**TORX:** T6 / T7 / T8 / T10 / T15 / T20 / T27 / T30  
**HEX (mm):** 2.5 / 3 / 3.5 / 4 / 4.5 / 5 / 5.5 / 6 / 7 / 8

## GUNSMITHING SCREWDRIVER UPGRADE KIT

PRODUCT: 748555      UPC: 661120485551

- 15 GUNSMITHING SPECIALTY BITS
- DURABLE S2 TOOL STEEL

Contains the 15 Specialty Bits, shaft extension and square to hex adapter found in the 89 Piece Professional Gunsmithing Screwdriver Set. Upgrade your 72 Piece Screwdriver Set or 43 Piece Set with these gunsmithing specialty bits.

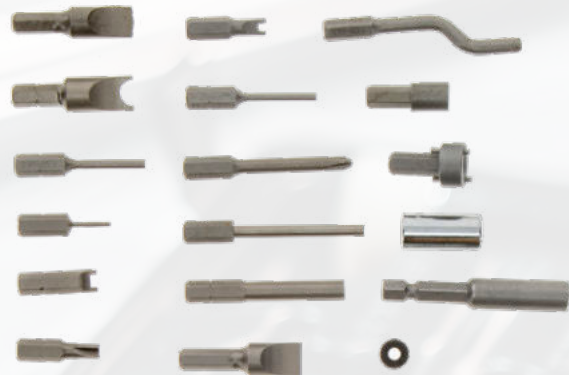

## 45 PIECE SAE/METRIC HEX & TORX KEY SET

PRODUCT: 1081959      UPC: 661120412748

- INCLUDES SAE/METRIC HEX AND TORX KEYS
- HARD PLASTIC STORAGE CASE ORGANIZES KEYS BY SIZE

Store all your key sets in one place with the Wheeler® 45-Piece Key Set. This convenient set allows you to store all SAE and Metric Hex and Torx keys together. Never again will you have to dig around for odd or different sizes, simply open your kit, turn to the page you need and continue working.

### INCLUDED KEYS:

**TORX:** T1 / T2 / T3 / T4 / T5 / T6 / T7 / T8 / T9 / T10 / T15  
 T20 / T25 / T30 / T35  
**METRIC HEX (mm):** 0.7 / 0.9 / 1.3 / 1.5 / 2 / 2.5 / 3  
 4 / 4.5 / 5 / 5.5 / 6 / 7 / 8 / 10  
**SAE HEX (in):** 0.028 / 0.035 / 0.05 / 1/16 / 5/64 / 3/32  
 7/64 / 1/8 / 9/64 / 5/32 / 3/16 / 7/32 / 1/4 / 5/16 / 3/8



# 30 PIECE P-HANDLE DRIVER SET

PRODUCT: 1081957      UPC: 661120412724

- FEATURES 30 SAE/METRIC HEX AND TORX DRIVERS
- ERGONOMIC P-HANDLE DESIGN ALLOWS FOR SECURE AND COMFORTABLE GRIP
- MOLDED STAND CAN SIT ON BENCH TOP OR MOUNT TO WALL

Complete your workbench with the Wheeler 30-Piece P-Handle Driver Set. The sleek molded stand design paired with its ability to be mounted on the wall allow for quick, convenient access to the SAE Hex, Metric Hex and Torx drivers, making it the perfect addition to any work shop.

### INCLUDED BITS:

**TORX:** T7 / T8 / T9 / T10 / T15 / T20 / T25 / T27 / T30 / T40

**METRIC HEX (mm):** 1.5 / 2 / 2.5 / 3 / 4 / 5 / 6 / 7 / 8 / 10

**SAE HEX (in):** 3/32 / 7/64 / 1/8 / 9/64 / 5/32 / 3/16  
7/32 / 1/4 / 5/16 / 3/8



# MICRO MULTI-DRIVER TOOL PEN

PRODUCT: 1082257      UPC: 661120412809

- ALUMINUM HANDLE CONSTRUCTION
- INCLUDES 17 INTERCHANGEABLE BITS
- STORES 5 BITS INTERNALLY
- COMPACT BIT HOLDER CARRIES 12 BITS

Have the bits you need on hand for your most intricate gunsmithing projects with the Wheeler® Micro Multi-Driver Tool Pen. Its convenient shape fits comfortably in your hand and is equipped to hold 5 of your most used bits.

### INCLUDED INTERCHANGEABLE BITS:

**HEX:** H0.9 / H1.3 / H1.5 / H2

**SLOTTED:** SL1.5 / SL2 / SL2.5 / SL3

**PHILLIPS:** PH00 / PH0 / PH1

**TORX:** T5 / T6 / T7

**TORX SECURITY:** TR8 / TR9 / TR10



# MULTI-DRIVER TOOL PEN

PRODUCT: 1082256      UPC: 661120412816

- ALUMINUM HANDLE CONSTRUCTION
- STORES 6 BITS INTERNALLY
- INCLUDES 13 INTERCHANGEABLE BITS
- COMPACT BIT HOLDER CARRIES 7 BITS

Have the bits you need, on hand, with the Wheeler® Multi-Driver Tool Pen. Who wants to drag their entire screwdriver set to the range? This small tool is perfect for travel. Its convenient shape fits comfortably in your hand and is equipped to hold 6 of your most used bits.

### INCLUDED INTERCHANGEABLE BITS:

**HEX SAE:** H5/64 / H3/32 / H1/8 / H5/32

**SLOTTED:** SL3 / SL4 / SL4.5

**PHILLIPS:** PH1 / PH2

**TORX:** T10 / T15 / T20 / T25



## PRECISION SCREWDRIVER SET

PRODUCT: 564018

UPC: 661120640189

- CHROME PLATED STEEL BITS
- EXTENDABLE HANDLE FROM 3 3/4" - 5 1/2"
- 5 3/4" FLEXIBLE EXTENSION SHAFT
- PRECISION-FORMED BITS FOR FASTENER ENGAGEMENT

The Wheeler® Precision Screwdriver Set is a 58 piece precision screwdriver set is the perfect size to throw in your range bag. Use the extra small bits for adjusting everything from sights to lasers and even your safety glasses.



## F.A.T. WRENCH® FIREARM ACCURIZING TORQUE

PRODUCT: 553556

UPC: 661120535560

- BITS ARE MADE FROM S2 TOOL STEEL AND HARDENED TO 56-58 ROCKWELL "C"
- TORQUE ADJUSTMENT RANGE FROM 10 IN/LBS TO 65 IN/LBS
- ACCURACY PLUS/MINUS 2 IN/LBS UP TO 40 IN/LBS; 40-65 IS +/- 5%

The Wheeler® F.A.T. Wrench® (Firearm Accurizing Torque) brings perfect consistency to every screw on your rifle. This amazing, handheld torque wrench lets you apply repeatable, accurate torque settings to scope bases and rings, action screws, and more. This prevents damage to optics and firearms, and decreases the chances of failure in the field. The large range of 10-65 in/lbs. will aid in accurately torqueing screws to recommended specifications. The F.A.T. Wrench includes 10 bits built to last, made from S2 tool steel hardened to 56-58 Rockwell C. The included custom-molded case is perfect for storing the wrench and bits when not in use.



## DIGITAL F.A.T. WRENCH® FIREARM ACCURIZING TORQUE

PRODUCT: 710909

UPC: 661120109099

- BITS ARE MADE FROM S2 TOOL STEEL AND HARDENED TO 56-58 ROCKWELL C
- ERGONOMIC OVER MOLDED DESIGN
- LARGE LCD DIGITAL DISPLAY FOR EASE OF VIEWING
- AUDIBLE INDICATOR TONE
- FULL SET OF BITS INCLUDED

The Wheeler® Digital F.A.T. Wrench® (Firearm Accurizing Torque) brings precise torque settings to the handheld torque wrench market. This digital handheld torque wrench lets you apply repeatable, accurate torque settings to scope bases and rings, action screws, and more. The audible and visual indicators let the user know exactly when the desired torque setting has been achieved. The large range of 15-100 in/lbs. will aid in accurately torqueing screws to recommended specifications. The Digital F.A.T. Wrench includes 10 bits built to last, made from S2 tool steel hardened to 56-58 Rockwell C. The included custom-molded case is perfect for storing the wrench and bits when not in use.



# UNIVERSAL 1911/PISTOL BENCH BLOCK

PRODUCT: 672215      UPC: 661120188278

- MAIN SPRING REMOVAL RECESS AND BOSS
- BARREL LINK REMOVAL V CHANNEL
- REAR SIGHT DRIFT CHANNEL AND FRONT SIGHT STAKING CHANNEL
- HAMMER AND SEAR PIN REMOVAL HOLES
- EJECTOR PORT DRESSING CHANNEL

Made of non-marring urethane, the Wheeler® Universal 1911/Pistol Bench Block is perfect for use on M1911 pistols as well as other firearms such as 10/22s.



# ARMORER'S HANDGUN SIGHT TOOL

PRODUCT: 710905      UPC: 661120109051

- FULLY CAPTURES AND SUPPORTS SLIDE
- SIGHT PRONG IS REVERSIBLE TO ACCOMMODATE GLOCKS
- WORKS ON ALL SEMI-AUTO PISTOLS
- LARGE 4-POST DRIVE KNOB TO EASILY PUSH THE SIGHT

The Wheeler® Armorer's Handgun Sight Tool is designed for adjusting, installing or removing dovetail style front and rear handgun sights. Made of high end materials, the Wheeler® Armorer's Handgun Sight Tool will last for years of use.

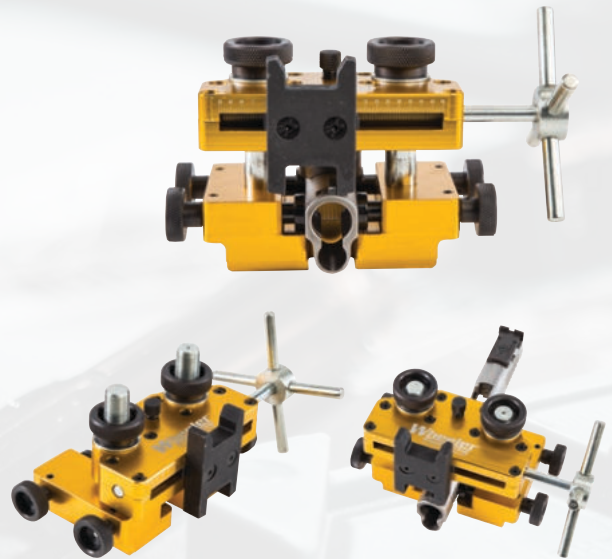

# UNIVERSAL BARREL CLAMP

PRODUCT: 672286      UPC: 661120722861

- PRECISION EXTRUDED FROM AIRCRAFT GRADE ALUMINUM
- BONDED WITH NON-MARRING URETHANE

The Wheeler® Universal Barrel Clamp is precision extruded from aircraft grade aluminum and bonded with non-marring urethane. The urethane coating is specially designed to provide a protective layer for the barrel's finish while providing extraordinary gripping abilities. Three different barrel openings of .85", .66" and .53" will accommodate anything from an AR pencil barrel up to a bull barrel

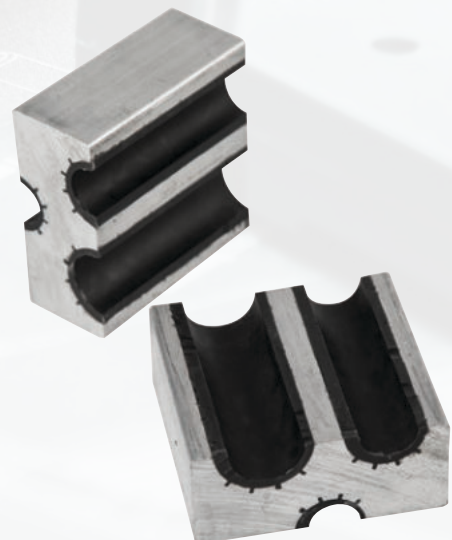

# TRIGGER PULL GAUGE

PRODUCT: 309888      UPC: 661120098881

- ACCURATELY MEASURES TRIGGER PULL IN 2 OZ INCREMENTS
- ACCURATE TO +/- 2 OZ
- EASY-TO-READ SLIDING INDICATOR
- RANGE FROM 8 OZ. TO 8LBS

The Wheeler® Trigger Pull Scale accurately measures trigger pull weight from 8 ounces to 8 pounds. It features an ergonomically shaped handle for consistent direction of pull. Highly visible increment markings and easy to read sliding indicator that stays on the maximum weight registered.



# PROFESSIONAL DIGITAL TRIGGER GAUGE

PRODUCT: 710904      UPC: 661120109044

- 0-12LBS RANGE WITH MIN, MAX, AVERAGE, AND LIVE FUNCTIONS
- LOAD SENSOR DIRECTLY CONTACTS THE TRIGGER
- ARM FOLDS INSIDE HOUSING TO PROTECT THE LOAD SENSOR WHEN NOT IN USE
- AUDIBLE INDICATOR TONE

The Wheeler® Professional Digital Trigger Gauge features an over-molded design for a consistent line of pull and soft-touch buttons for comfort. Includes bladed trigger adapter to allow use with triggers that have internal safety blades. Also includes a foam lined storage case.



# PROFESSIONAL FILE SET

PRODUCT: 710908      UPC: 661120109082

**KIT INCLUDES:**

- |                      |                             |                             |
|----------------------|-----------------------------|-----------------------------|
| • 8" HALF ROUND FILE | • FILE CLEANING BRUSH       | • FLAT MEDIUM GRIT FILE     |
| • 8" FLAT FILE       | • EXTRA-FINE DIAMOND PLATE  | • ROUND MEDIUM GRIT FILE    |
| • 6" SQUARE FILE     | • STICK OF FILE CHALK       | • TRIANGLE MEDIUM GRIT FILE |
| • 6" TRIANGLE FILE   | • FLAT COARSE GRIT FILE     | • FLAT LINE GRIT FILE       |
| • 6" ROUND FILE      | • ROUND COARSE GRIT FILE    | • ROUND FINE GRIT FILE      |
| • 4-IN-1 RASP        | • TRIANGLE COARSE GRIT FILE | • TRIANGLE FINE GRIT FILE   |

The Wheeler® Professional Gunsmithing File Set is perfect for many different gunsmithing jobs. The set comes with a wide grade of files from a rough rasp all the way down to a super, extra fine diamond plate. All files fit neatly in roll-up case for storage.



## BARREL VISE WITH 3 OAK BUSHINGS

PRODUCT: 465185      UPC: 661120195177

- SECURELY CLAMP YOUR BARREL FOR REMOVAL OR INSTALLATION
- BARREL VISE INCLUDES TWO PRE-DRILLED OAK BLOCKS, 1" AND 3/4" AND A SOLID BLOCK FOR CUSTOM DRILLING

### REPLACEMENT OAK BUSHINGS (3 PACK)

PRODUCT: 844879      UPC: 661120194712

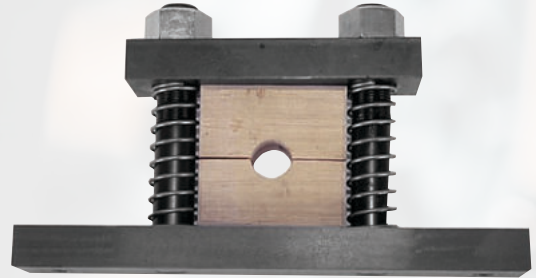

## NYLON/BRASS HAMMER

PRODUCT: 711016      UPC: 661120110163

- NON-MARRING NYLON FACE
- BRASS FACE CAN BE USED FOR DRIVING PINS AND PUNCHES
- 11" LENGTH

The Wheeler® Nylon/Brass Hammer is likely to become your favorite hammer on the bench, or at the range. The nylon face is non-marring and is great for alignment and other uses where a steel hammer is not appropriate. The brass face can be used for driving pins and punches, as well as a multitude of other uses.



## MASTER INTERCHANGEABLE HAMMER SET

PRODUCT: 110268      UPC: 661120001997

### KIT INCLUDES:

- TWO MACHINED METAL HAMMER BODIES
- HAMMER FACES: METAL, BRASS, NYLON, RUBBER
- DURABLE BLOW - MOLDED CASE FOR STORAGE

The Wheeler® Master Interchangeable Hammer Set features two precision-machined hammer bodies. The large hammer is ideal for driving out large or stubborn pins. The small hammer is perfect when precise control is necessary. The set comes with 8 interchangeable hammer faces made from metal, brass, nylon, and rubber for a variety of jobs.



# HAMMER PUNCH SET

PRODUCT: 951900

UPC: 661120519003

**KIT INCLUDES:**

- POLYMER AND BRASS HAMMER FACES
- EIGHT PRECISION BRASS PUNCHES
- FOUR STEEL PUNCHES
- TWO NON-MARRING POLYMER PUNCHES
- MOLDED STORAGE CASE



The Wheeler® Hammer Punch Set is a great tool for driving pins or drifting sights at the range or on your bench. Two hammer faces and a wide variety of punches allow for an assortment of jobs. Everything is neatly organized in the molded case for convenient storage.

# MASTER ROLL PIN PUNCH SET

PRODUCT: 110128

UPC: 661120001409

**KIT INCLUDES:**

- 5/16"      • 3/16"      • 3/32"
- 1/4"        • 5/32"      • 5/64"
- 7/32"      • 1/8"        • 1/16"



The Wheeler® Master Roll Pin Punch Set combines two of our best pin sets with a gunsmithing hammer into one convenient kit. Counter-bored starter punches keep roll pins aligned for easy starting. The roll pin punches are designed with a hemispherical tip to provide proper alignment of the roll pin to prevent damage to the roll pin and firearm. All pins feature knurled handles for a secure hold when using.

# BRASS PUNCH SET

PRODUCT: 780194

UPC: 661120801948

**KIT INCLUDES:**

- 5/16"      • 3/16"      • 3/32"
- 1/4"        • 5/32"      • 5/64"
- 7/32"      • 1/8"        • 1/16"



The Wheeler® Brass Punch Set features eight punches ranging in size from 1/8"-5/16". All punches are easily stored in the convenient roll-up pouch.

## ROLL PIN STARTER SET

PRODUCT: 710910

UPC: 661120109105

**KIT INCLUDES:**

- 5/16"      • 3/16"      • 3/32"
- 1/4"      • 5/32"      • 5/64"
- 7/32"      • 1/8"      • 1/16"

The Wheeler® Roll Pin Starter Set are machined from hardened steel to prevent bending or breaking while starting any size roll pin. The punches are designed with a beveled tip for starting the roll pin.



## ROLL PIN PUNCH SET

PRODUCT: 204513

UPC: 661120045137

**KIT INCLUDES:**

- 5/16"      • 3/16"      • 3/32"
- 1/4"      • 5/32"      • 5/64"
- 7/32"      • 1/8"      • 1/16"

The Wheeler® Roll Pin Punches are machined from hardened steel to prevent bending or breaking while driving any size roll pin. The punches are designed with a hemispherical tip to provide proper alignment of the roll pin to prevent damage to the roll pin and firearm. All punches are organized in the convenient roll-up pouch.



## SAVAGE BARREL NUT WRENCH

PRODUCT: 123038

UPC: 661120230380

- FITS EARLY AND LATE MODEL NUTS ON THE 110 AND 10 SERIES RIFLES

The Wheeler® Savage Barrel Nut Wrench delivers the strength and rigidity required for proper barrel removal and installation. The action wrench safely surrounds and supports the receiver ring. The 15" long, 1" diameter steel handle will overcome even the tightest assemblies. The double ended savage barrel nut wrench fits both early and late model nuts on the 110 and 10 series rifles with both square or round notch barrel nuts. A second wrench is included for smooth barrel nuts with a non-marring brass shim. It also features two 1/2" square drive holes for a swing bar or a torque wrench.





# ACTION WRENCH #1

## MAUSER / FLAT BOTTOMED RECEIVER

PRODUCT: 808771      UPC: 661120195634

- SAFELY SURROUNDS AND SUPPORTS RECEIVER RING

Heavy duty tools to deliver the strength and rigidity required for proper barrel removal and installation. The Wheeler® Action Wrench wrench safely surrounds and supports the receiver ring. The 15" long, 1" diameter steel handle will overcome even the tightest assemblies.



# ACTION WRENCH #2

## REMINGTON 700

PRODUCT: 414521      UPC: 661120195405

- SAFELY SURROUNDS AND SUPPORTS RECEIVER RING

Heavy duty tools to deliver the strength and rigidity required for proper barrel removal and installation. The Wheeler® Action Wrench wrench safely surrounds and supports the receiver ring. The 15" long, 1" diameter steel handle will overcome even the tightest assemblies.



# CERAMA COAT

## CUSTOM GUN ARMOR

PRODUCT: 468993    **BLACK**      UPC: 661120689935

PRODUCT: 492304    **FDE**      UPC: 661120923046

PRODUCT: 567312    **OLIVE DRAB**      UPC: 661120673125

- HIGHLY RESISTANT TO SCRATCHING, CHIPPING, AND GUN SOLVENTS
- WEATHERPROOF, MATTE FINISH
- BONDS TO FERROUS METALS, ALLOYS, STAINLESS STEEL AND SYNTHETICS THAT CAN BE HEATED TO 200 OF
- 4 OZ CAN

The Wheeler® Cerama-Coat is a specifically formulated finish that provides an extremely durable coating. The key to the super hard finish is ultra-fine ceramic molecules that crosslink and bond to the base material.



# BEDROCK BEDDING KIT

PRODUCT: 190274

UPC: 661120902744

### KIT INCLUDES:

- 4 OZ BEDROCK
- 3 MIXING CUPS
- BROWN & BLACK DYE
- 3 MIXING/APPLICATOR STICKS
- 2 FL OZ MICROBALLOONS
- RELEASE AGENT
- MODELING CLAY
- 2 RELEASE AGENT APPLICATORS
- SURGICAL TUBING

A rifle's accuracy is dependent on the fit of its barreled action to its stock. The Wheeler® Bedrock Bedding Kit makes your rifle's stock and metal components fit together to eliminate shift and pressure points caused by recoil and changes in temperature and humidity. Removing the contact points of the stock where the barreled action meets, and replacing them with Bedrock assures you of a perfect, stress-free fit.



# LEAD BARREL VISE SHIMS (4 PACK)

PRODUCT: 239444

UPC: 661120194941

- INCLUDES 4 LEAD BARREL VISE SHIMS.
- SHIMS CAN BE REUSED MULTIPLE TIMES.

Wheeler® Vise Shims are recommended to line between barrel and vise bushings. It improves the grip of the firearm and won't damage steel or bluing.



# RECOIL PAD INSTALLATION FIXTURE

PRODUCT: 184528

UPC: 661120845287

The Wheeler® Recoil Pad Installation Fixture accurately transfers the toe-line angle and the comb line from the stock to the new recoil pad; also serves as a stable work holding fixture for off-the-stock sanding of the pad. Designed for use with any table-mounted belt or disc sander. Rigid, cast aluminum base and aluminum pad mounting bar.

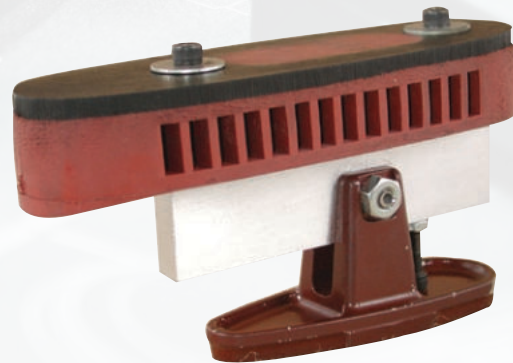

## BOLT ACTION SCOPE MOUNTS (1 PIECE)

### FITS REMINGTON® MODEL 700® LONG ACTION

|                  |                        |                   |
|------------------|------------------------|-------------------|
| PRODUCT: 1110071 | <b>1" MED</b>          | UPC: 661120079347 |
| PRODUCT: 1110072 | <b>1" HIGH</b>         | UPC: 661120079354 |
| PRODUCT: 1108715 | <b>30MM MED</b>        | UPC: 661120079118 |
| PRODUCT: 1108716 | <b>30MM HIGH</b>       | UPC: 661120079132 |
| PRODUCT: 1108717 | <b>30MM EXTRA HIGH</b> | UPC: 661120079149 |
| PRODUCT: 1108718 | <b>34MM MED</b>        | UPC: 661120107859 |
| PRODUCT: 1108719 | <b>34MM HIGH</b>       | UPC: 661120079156 |
| PRODUCT: 1108720 | <b>34MM EXTRA HIGH</b> | UPC: 661120079163 |

- FITS REMINGTON® MODEL 700® LA
- 6061 ALUMINUM CONSTRUCTION
- 6 HOLE RING DESIGN
- 20 MOA ELEVATION IN BASE
- FLIP-OUT ANTI-CANT INDICATOR
- AVAILABLE IN 1", 30MM, AND 34MM RING SIZES



## BOLT ACTION SCOPE MOUNTS (1 PIECE)

### FITS REMINGTON® MODEL 700® SHORT ACTION

|                  |                        |                   |
|------------------|------------------------|-------------------|
| PRODUCT: 1110068 | <b>1" MED</b>          | UPC: 661120079323 |
| PRODUCT: 1110069 | <b>1" HIGH</b>         | UPC: 661120079330 |
| PRODUCT: 1108709 | <b>30MM MED</b>        | UPC: 661120078852 |
| PRODUCT: 1108710 | <b>30MM HIGH</b>       | UPC: 661120078869 |
| PRODUCT: 1108711 | <b>30MM EXTRA HIGH</b> | UPC: 661120078876 |
| PRODUCT: 1108712 | <b>34MM MED</b>        | UPC: 661120079088 |
| PRODUCT: 1108713 | <b>34MM HIGH</b>       | UPC: 661120079095 |
| PRODUCT: 1108714 | <b>34MM EXTRA HIGH</b> | UPC: 661120079101 |

- FITS REMINGTON® MODEL 700® LA
- 6061 ALUMINUM CONSTRUCTION
- 6 HOLE RING DESIGN
- 20 MOA ELEVATION IN BASE
- FLIP-OUT ANTI-CANT INDICATOR
- AVAILABLE IN 1", 30MM, AND 34MM RING SIZES



## BOLT ACTION SCOPE MOUNTS (1 PIECE)

### FITS SAVAGE® 10 SHORT ACTION

|                  |                        |                   |
|------------------|------------------------|-------------------|
| PRODUCT: 1110074 | <b>1" MED</b>          | UPC: 661120079361 |
| PRODUCT: 1110075 | <b>1" HIGH</b>         | UPC: 661120079378 |
| PRODUCT: 1108721 | <b>30MM MED</b>        | UPC: 661120079170 |
| PRODUCT: 1108722 | <b>30MM HIGH</b>       | UPC: 661120079187 |
| PRODUCT: 1108723 | <b>30MM EXTRA HIGH</b> | UPC: 661120079194 |
| PRODUCT: 1108724 | <b>34MM MED</b>        | UPC: 661120079200 |
| PRODUCT: 1108725 | <b>34MM HIGH</b>       | UPC: 661120079217 |
| PRODUCT: 1108726 | <b>34MM EXTRA HIGH</b> | UPC: 661120079224 |

- FITS SAVAGE® 10
- 6061 ALUMINUM CONSTRUCTION
- 6 HOLE RING DESIGN
- 20 MOA ELEVATION IN BASE
- FLIP-OUT ANTI-CANT INDICATOR
- AVAILABLE IN 1", 30MM, AND 34MM RING SIZES



## BOLT ACTION SCOPE MOUNTS (1 PIECE)

*FITS SAVAGE® 110 LONG ACTION*

|                  |                        |                   |
|------------------|------------------------|-------------------|
| PRODUCT: 1110077 | <b>1" MED</b>          | UPC: 661120079385 |
| PRODUCT: 1110078 | <b>1" HIGH</b>         | UPC: 661120079392 |
| PRODUCT: 1108727 | <b>30MM MED</b>        | UPC: 661120079231 |
| PRODUCT: 1108728 | <b>30MM HIGH</b>       | UPC: 661120079248 |
| PRODUCT: 1108729 | <b>30MM EXTRA HIGH</b> | UPC: 661120079255 |
| PRODUCT: 1108730 | <b>34MM MED</b>        | UPC: 661120079262 |
| PRODUCT: 1108731 | <b>34MM HIGH</b>       | UPC: 661120079279 |
| PRODUCT: 1108732 | <b>34MM EXTRA HIGH</b> | UPC: 661120079286 |

- FITS SAVAGE® 110
- 6061 ALUMINUM CONSTRUCTION
- 6 HOLE RING DESIGN
- 20 MOA ELEVATION IN BASE
- FLIP-OUT ANTI-CANT INDICATOR
- AVAILABLE IN 1", 30MM, AND 34MM RING SIZES



## CANTILEVER SCOPE MOUNTS (1 PIECE)

|                  |             |                   |
|------------------|-------------|-------------------|
| PRODUCT: 1110077 | <b>1"</b>   | UPC: 661120417224 |
| PRODUCT: 1110078 | <b>30MM</b> | UPC: 661120417231 |
| PRODUCT: 1108727 | <b>34MM</b> | UPC: 661120418863 |

- 2" CANTILEVER EXTENSION
- HARDWARE INCLUDED (TORX SCREWS)
- 6 HOLE RING DESIGN
- RETAINED 1/2" LOCK NUTS SECURE TO PIC RAIL
- FLIP-OUT ANTI-CANT INDICATOR

Get the perfect mount with Wheeler® 1 Piece Bolt Action Scope Mounts. Made of 6061 aluminum, the 6 hole ring design features a swing-out anti-cant indicator. Designed to fit on any AR or Precision Rifle with a Pic Rail, these 1 piece scope mounts are available in 1", 30mm, and 34mm ring sizes.



## PICATINNY SCOPE MOUNTS (1 PIECE)

|                  |                  |                   |
|------------------|------------------|-------------------|
| PRODUCT: 1099951 | <b>34MM LOW</b>  | UPC: 661120417989 |
| PRODUCT: 1099947 | <b>34MM MED</b>  | UPC: 661120417996 |
| PRODUCT: 1100186 | <b>34MM HIGH</b> | UPC: 661120417972 |
| PRODUCT: 1099954 | <b>30MM LOW</b>  | UPC: 661120417255 |
| PRODUCT: 1099955 | <b>30MM MED</b>  | UPC: 661120417262 |
| PRODUCT: 1099956 | <b>30MM HIGH</b> | UPC: 661120417248 |
| PRODUCT: 1099904 | <b>1" LOW</b>    | UPC: 661120417200 |
| PRODUCT: 1099907 | <b>1" MED</b>    | UPC: 661120417217 |
| PRODUCT: 1099903 | <b>1" HIGH</b>   | UPC: 661120417194 |

- 6061 ALUMINUM CONSTRUCTION
- HARDWARE INCLUDED (TORX SCREWS)
- 6 HOLE RING DESIGN
- RETAINED 1/2" LOCK NUTS SECURE TO PIC RAIL
- FLIP-OUT ANTI-CANT INDICATOR



# ANTI-CANT INDICATOR

PRODUCT: 755712 **1"** UPC: 661120557128  
 PRODUCT: 766112 **30MM** UPC: 661120661122  
 PRODUCT: 580033 **PIC RAIL** UPC: 661120800330

- INDICATES PRECISE, REPEATABLE LEVEL GUN POSITION
- EASY-TO-VIEW FROM SHOOTING POSITION
- FOLDS IN WHEN NOT IN USE
- ATTACHES VIA UNIVERSAL PICATINNY RAIL ATTACHMENT OR DIRECTLY TO SCOPE
- PRECISION MACHINED ALUMINUM WITH ANODIZED FINISH

Keeping your scope perfectly aligned is critical to long-range accuracy. Canting your scope, even just a couple of degrees, can cause error in point of impact. With modern "Drop-Compensating" scopes, The Wheeler® Anti-Cant Indicator is a necessity.

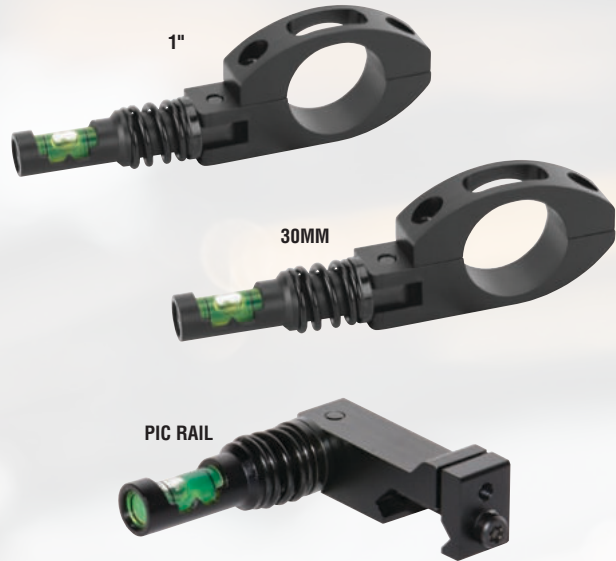

# PROFESSIONAL SCOPE MOUNTING KITS

PRODUCT: 540127 **1"** UPC: 661120401278  
 PRODUCT: 545454 **1" & 30MM** UPC: 661120454540

**KIT INCLUDES:**

- F.A.T. WRENCH
- FLEX DRIVER
- LAPPING COMPOUND
- 10 BITS
- LAPPING BAR(S) ALIGNMENT BARS
- THREAD LOCKER
- 1/2 SOCKET
- LAPPING BAR HANDLE
- STORAGE CASE

The Wheeler® Professional Scope Mounting Kit will properly align, attach and level your scope on your gun. Alignment and lapping bars make ring alignment simple and easy. The Level-Level-Level provides precise leveling for your scope and the F.A.T. Wrench® guarantees exact torque specs on your scope rings. A flex driver is included for use with a power drill.



# ULTRA SCOPE MOUNTING KIT

PRODUCT: 541010 UPC: 661120410102

**KIT INCLUDES:**

- F.A.T. WRENCH
- LENS PEN
- THREAD LOCKER
- HEAVY-DUTY STORAGE CASE WITH FOAM-MOLDED INSERTS
- PROFESSIONAL RETICLE LEVELING SYSTEM
- 10 BITS AND ONE SOCKET WITH BIT HOLDER
- GREEN PROFESSIONAL LASER BORE SIGHTER



The Wheeler® Ultra Scope Mounting Kit puts all the best scope mounting accessories into one perfect package. With this kit you can level your rifle and scope, mount your scope to the rifle, and bore sight your scope with precision and accuracy. The Ultra Scope Mounting Kit even provides a lens pen and thread locker to keep your scope clean and your optics secure on even the largest caliber guns. Includes a heavy duty carry case to keep components organized and secured.

# LEVEL-LEVEL-LEVEL

PRODUCT: 113088

UPC: 661120130888

- FEATURES TWO LEVELS TO CALIBRATE THE SCOPE TO THE GUN
- SCOPE TURRET LEVEL SITS ON TOP OF SCOPE TURRET
- ACTION LEVEL MAGNETICALLY ATTACHES TO GUN'S ACTION

The Wheeler® Level-Level-Level works by leveling the scope to the receiver, not to the top of a scope base. This scope mounting level works with practically any bolt-action rifle and is adaptable to other designs as well.



# PROFESSIONAL RETICLE LEVELING SYSTEM

PRODUCT: 119050

UPC: 661120190509

**KIT INCLUDES:**

- TWO CALIBRATED MACHINED ALUMINUM LEVEL HOUSINGS
- FOAM-MOLDED STORAGE CASE

The Wheeler® Professional Reticle Leveling System (PRLS) is a precision tool designed to allow a scope to be perfectly leveled on any firearm with ease by leveling the scope to the gun itself. The adjustable Barrel Clamp Level fits around even the largest diameter barrels (including shotguns) and features non-marring pads to prevent damage. The Reference Level has a magnetic bottom to ensure stability.



# PROFESSIONAL LASER BORE SIGHTER

PRODUCT: 580022 **RED LASER** UPC: 661120800224

PRODUCT: 589922 **GREEN LASER** UPC: 661120899228

**KIT INCLUDES:**

- PLASTIC STORAGE CASE
- LITHIUM 123A BATTERY
- REFLECTIVE SIGHTING GRID

The Wheeler® Professional Laser Bore Sighter uses a high-power laser and a high-strength magnetic connection to the barrel to deliver fast accurate bore sighting. This system works with virtually all firearms; rifles, shotguns, handguns. The Machined aluminum housing is factory calibrated with the laser for extreme accuracy.





**LOCKDOWN** | 2023 NEW PRODUCTS

## SECUREWALL PANELS

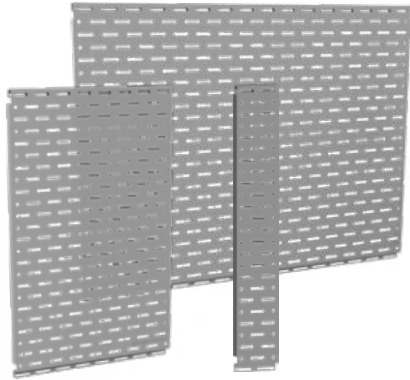

INTERCONNECTING PANELS FOR SEAMLESS APPEARANCE AND MAXIMUM SURFACE AREA USE

POWDER COATED FOR NON-MARRING OF VALUABLES

PATENT PENDING PATTERN IS COMPATIBLE WITH LOCKDOWN ACCESSORIES AND UNIVERSAL PEG ATTACHMENTS FOR STORAGE OF ALL TYPES OF VALUABLES

**SD** STANDARD PANELS ARE FOR GENERAL STORAGE, ORGANIZATION, AND DISPLAY OF FIREARMS AND GEAR

**HD** HEAVY DUTY PANELS ARE COMPATIBLE WITH HIGH DENSITY STORAGE OF FIREARMS, AMMO CANS, AND BODY ARMOR

Elevate and transform any space into custom storage to organize your firearms with the **SecureWall** system. Display firearms across your wall with Lockdown **SecureWall** panels or pack gear and ammo cans from top to bottom with Lockdown Heavy Duty **SecureWall** panel options. Outfitted with a patent pending pattern, panels are compatible with a wide variety of Lockdown accessories and universal peg attachments.

## SECUREWALL PANELS

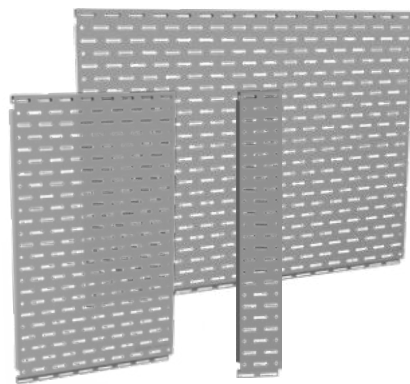

STANDARD LARGE PANEL  
SKU 1162198 // UPC 661120651918 // CASE PACK 2  
PRODUCT DIMENSIONS 32"W x 24"H

STANDARD PANEL  
SKU 1183936 // UPC 661120651895 // CASE PACK 2  
PRODUCT DIMENSIONS 16"W x 24"H

STANDARD NARROW PANEL  
SKU 1196115 // UPC 661120747413 // Case Pack 4  
PRODUCT DIMS 4"W x 24"H

HEAVY DUTY LARGE PANEL  
SKU 1186123 // UPC 661120651901 // CASE PACK 2  
PRODUCT DIMENSIONS 32"W x 24"H

HEAVY DUTY PANEL  
SKU 1186124 // UPC 661120651888 // CASE PACK 2  
PRODUCT DIMENSIONS 16"W x 24"H

STANDARD



HEAVY DUTY



## SECUREWALL UNIVERSAL ADAPTER

SKU 1162200 // UPC 661120651963 // CASE PACK 10  
PRODUCT DIMENSIONS 0.19"H x 0.38"W x 0.75"D

ALLOWS OTHER LOCKDOWN PRODUCTS TO ATTACH TO SECUREWALLS SUCH AS THE MAGAZINE RACK, MAGNUM MAGNET, GUN CONCEALMENT MAGNET AND DEHUMIDIFIER RODS.

4 PACK INCLUDES T-NUTS AND FASTENERS

ATTACH LIGHTS, FLAGS, METAL SIGNS, AND OTHER VAULT ROOM NECESSITIES



Screw anything you can imagine into your securewall panels using the universal adapter.





## SECUREWALL

### HANDGUN HANGER

SKU 1160807 // UPC 661120651956 // CASE PACK 10

PRODUCT DIMENSIONS 2.4"H x 3"W x 3.15"D



- POWDER COATED TO PROTECT YOUR FIREARMS
- COMPATIBLE WITH LOCKDOWN'S PATENT PENDING PATTERN PANELS

- HOLDS ALL STYLES OF HANDGUNS
- PROPRIETARY DESIGN QUICKLY AND EASILY LOCKS ONTO WALL PANEL TO SECURELY HOLD YOUR FIREARMS

Show off your favorite handguns with the Handgun Hanger. Its horizontal orientation makes for a great display.



## SECUREWALL

### LONG GUN HANGER

SKU 1160808 // UPC 661120651970 // CASE PACK 10

PRODUCT DIMENSIONS 2.4"H x 1.35"W x 3.75"D



- POWDER COATED ATTACHMENT WITH VINYL COATED HOOKS FOR NON-MARRING OF FIREARMS
- COMPATIBLE WITH LOCKDOWN'S PATENT PENDING PATTERN PANELS

- PROPRIETARY DESIGN QUICKLY AND EASILY LOCKS ONTO WALL PANEL TO SECURELY HOLD YOUR FIREARMS

Display your most prized rifles and shotguns with the Long Gun Hanger. Its horizontal layout is perfect for showing off your firearms.

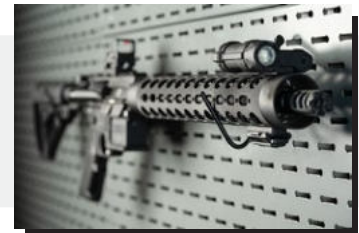

## SECUREWALL

### HANDGUN BARREL PEG, STRAIGHT

SKU 1186973 // UPC 661120651949 // CASE PACK 10

PRODUCT DIMENSIONS 2.4"H x 1.35"W x 4.65"D



- POWDER COATED ATTACHMENT WITH VINYL COATED PEG FOR NON-MARRING OF FIREARMS
- COMPATIBLE WITH LOCKDOWN'S PATENT PENDING PATTERN PANELS

- PROPRIETARY DESIGN QUICKLY AND EASILY LOCKS ONTO WALL PANEL TO SECURELY HOLD YOUR FIREARMS

- HIGH STRENGTH STEEL CONSTRUCTION TO HOLD ANY HANDGUN FROM .38 TO .50 CALIBER

For the utilitarian, the Straight Handgun Barrel Peg allows you to fit as many handguns as possible while still having easy access.



## SECUREWALL | HANDGUN BARREL PEG, ANGLED

SKU 1160809 // UPC 661120651932 // CASE PACK 10  
PRODUCT DIMENSIONS 2.4"H x 2.75"W x 4"D



- POWDER COATED ATTACHMENT WITH VINYL COATED PEG FOR NON-MARRING OF FIREARMS
- COMPATIBLE WITH LOCKDOWN'S PATENT PENDING PATTERN PANELS
- PROPRIETARY DESIGN QUICKLY AND EASILY LOCKS ONTO WALL PANEL TO SECURELY HOLD YOUR FIREARMS
- HIGH STRENGTH STEEL CONSTRUCTION TO HOLD ANY HANDGUN FROM .38 TO .50 CALIBER

For the space conscious, the angled Handgun Barrel Peg allows for a tight layout, but angles the handguns just enough to display them as well.



## SECUREWALL | VERTICAL GUN RACK

SKU 1160810 // UPC 661120651925 // CASE PACK 4  
PRODUCT DIMENSIONS 4.8"H x 9.75"W x 11"D



- POWDER COATED ATTACHMENT AND BASE FOR NON-MARRING OF FIREARMS
- COMPATIBLE WITH LOCKDOWN'S PATENT PENDING PATTERN PANELS
- PROPRIETARY DESIGN QUICKLY AND EASILY LOCKS ONTO WALL PANEL TO SECURELY HOLD YOUR FIREARMS
- HIGH STRENGTH STEEL CONSTRUCTION TO HOLD UP TO THREE SCOPED FIREARMS

Designed for armories, at home or an agency, the Vertical gun Rack is the ideal choice for storing as many rifles and shotguns as possible.

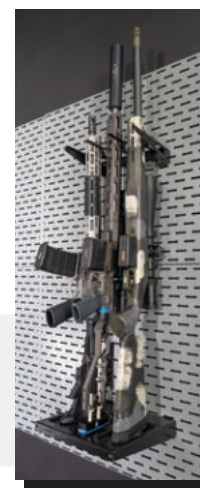

## SECUREWALL | UNIVERSAL HOOK

SKU 1160811 // UPC 661120651987 // CASE PACK 10  
PRODUCT DIMENSIONS 2.4"H x 1.35"W x 6.75"D

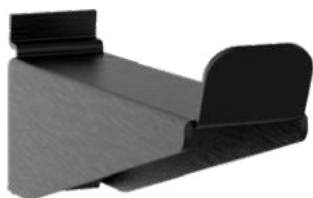

- POWDER COATED FOR NON-MARRING OF VALUABLES
- COMPATIBLE WITH LOCKDOWN'S PATENT PENDING PATTERN PANELS
- PROPRIETARY DESIGN QUICKLY AND EASILY LOCKS ONTO WALL PANEL TO SECURELY HOLD YOUR FIREARMS
- HIGH STRENGTH STEEL CONSTRUCTION TO SECURELY HOLD UP TO 40LBS

From backpacks, to plate carriers, to your favorite hats, the Universal Hook is versatile, yet strong enough to hold anything you can think of.



# SECURE your lifestyle™



## SECUREWALL SHELF

SKU 1160812 // UPC 661120651864 // CASE PACK 4  
PRODUCT DIMENSIONS 2.4"H x 9.75"W x 9"D



POWDER COATED FOR NON-MARRING OF VALUABLES

PROPRIETARY DESIGN QUICKLY AND EASILY LOCKS ONTO WALL PANEL TO SECURELY HOLD YOUR FIREARMS

COMPATIBLE WITH LOCKDOWN'S PATENT PENDING PATTERN PANELS

HIGH STRENGTH STEEL CONSTRUCTION TO SECURELY HOLD UP TO 40LBS

From ammo cans, to hard cases, to gun oil, each Shelf can hold up to 40lbs of gear.



## SECUREWALL BASKET

SKU 1160813 // UPC 661120651871 // CASE PACK 4  
PRODUCT DIMENSIONS 8"H x 11.75"W x 8"D



POWDER COATED FOR NON-MARRING OF VALUABLES

PROPRIETARY DESIGN QUICKLY AND EASILY LOCKS ONTO WALL PANEL TO SECURELY HOLD YOUR FIREARMS

COMPATIBLE WITH LOCKDOWN'S PATENT PENDING PATTERN PANELS

SECURELY HOLDS UP TO 15LBS

Perfect for holsters, spare magazines or whatever you have in order to declutter your space.



## LOGIC LOCKDOWN LOGIC™ APP

**FASTER. MORE RELIABLE.**

MONITORS THE STATUS OF ALL OF YOUR WI-FI CONNECTED LOCKDOWN® LOGIC™ PRODUCTS

CONTROL LOGIC™ PRODUCTS AT THE PALM OF YOUR HAND FROM ANYWHERE, ANYTIME

NO SUBSCRIPTION OR MONITORING FEES

4.2 STARS WITH OVER 200 RATINGS ON APP STORE

The Lockdown LOGIC™ App allows you access of your LOGIC products all from the palm of your hand. With zero subscription and usage fees, Lockdown® has enabled remote access to secure, monitor, and protect your valuables anywhere, anytime. **Free to download. Free to use.**



Google and Google Play are trademarks of Google LLC. Apple and the Apple Logo are trademarks of Apple Inc.

LOGIC

## LOCKDOWN PUCK™ -GEN2



NEW DOOR  
MAGNET

PATS:  
AOB.COM/PATENTS

SKU 1148222 // UPC 661120260356 // CASE PACK 4  
PRODUCT DIMENSIONS 3.2"H x 3.2"W x 1"D

- AUDIBLE ALARM TO ALERT TO TAMPERING AND IMPACT
- OVER-THE-AIR UPDATES FOR THE MOST UP-TO-DATE SOFTWARE
- NOTIFICATIONS FOR IMPACT, TAMPERING, TEMP/HUMIDITY, AND DOOR SENSOR STATE WITH THE FREE LOGIC™ APP
- ADJUSTABLE DOOR SENSOR WITH IMPROVED RELIABILITY FOR ANY DOOR OR STORAGE LOCATION
- WI-FI ENABLED WITH THE LOCKDOWN LOGIC™ APP

Ever-improving, we continue to set a new standard for firearm security and monitoring with the Lockdown Puck™ - Gen2. Put it anywhere you keep your firearms and valuables to receive notifications on temperature, humidity, tampering, and your door sensor's opened or closed state. Now with an optimized door sensor, faster notification response time and over-the-air updates, Lockdown® ensures you are always at the forefront of technology. Powered by USB or AA batteries, you can bring your security into the modern age with an affordable solution to ensure you are Lockdown Secured.

LOGIC

## HUMIDITY CONTROL KIT



PATS:  
AOB.COM/PATENTS

SKU 1197865 // UPC 661120655657 // CASE PACK 4  
PRODUCT DIMENSIONS PUCK - GEN2: 3.2"H x 3.2"W x 1"D | PLUG: 3.3"W x 1.5"H x 1.25"D  
DEHUMIDIFIER ROD (SKU 1071006): 12"W X .75"H X .75"D

- THE PUCK TEMPERATURE & HUMIDITY TRACKER
- THE PLUG REMOTE ON/OFF
- THE PUCK PUSH, TEXT OR EMAIL NOTIFICATIONS
- DEHUMIDIFIER ROD REMOVES MOISTURE FROM THE AIR

Take protection of your firearms to the next level with the Lockdown LOGIC Humidity Kit. This state of the art system combines 3 incredible products into 1 convenient package. The Puck will detect and monitor any changes in humidity, then alert you with the LOGIC app. Armed with this real time information, the Plug allows you to power on the Dehumidifier Rod with your phone from anywhere.

LOGIC

## LOCKDOWN LOGIC™ VAULT KEYPAD



PATS:  
AOB.COM/PATENTS

SKU 1135972 // UPC 661120107019 // CASE PACK 4 - Retrofit  
SKU 1146695 // UPC 661120107026 // CASE PACK 4 - OEM  
PRODUCT DIMENSIONS 4"H x 3.5"W x 1.25"D

- WI-FI AND BLUETOOTH™ ENABLED
- CREATE MASTER AND GUEST CODES
- TAMPERING & VIBRATION DETECTOR
- PUSH, TEXT, AND E-MAIL NOTIFICATIONS
- TEMPERATURE & HUMIDITY TRACKER
- NO SUBSCRIPTION FEES TO PAY

Bring your safe into the 21st Century with the Lockdown LOGIC™ Vault Retrofit Keypad. Compatible with common safe brands, swap out your old electronic keypad for an intelligent, Wi-Fi based, color screen that offers tampering and vibration detection, master and guest pin codes, humidity/temp tracker, and much more.



**LOCKDOWN**

**2023 RETURNING PRODUCTS**

## MOISTURE CONTROL

### AUTOMATIC DEHUMIDIFIER

SKU 1117251 // UPC 661120080527 // CASE PACK 2  
PRODUCT DIMENSIONS 7"W x 11"H x 5.25"D

### COMPACT AUTO DEHUMIDIFIER

SKU 1117252 // UPC 661120080510 // CASE PACK 4  
PRODUCT DIMENSIONS 6"W x 9.25"H x 4.5"D



DIGITAL CONTROL PANEL FOR READING IN LOW LIGHT ENVIRONMENTS



AUTOMATIC AND CUSTOM HUMIDITY CONTROL FOR PRESERVING VALUABLES

Lockdown's® Automatic Dehumidifiers are the ultimate in humidity protection. Available in a standard and compact size, the dehumidifiers remove moisture directly out of the air using an ultra-efficient thermo-electric process. Water drains into a holding tank or directly to a drain with the built-in extended hose connection. Best of all, the Automatic Digital Control turns the unit on only when the humidity gets high and turns it off when it's back under control. Preserve and protect your valuables with Lockdown's Automatic Dehumidifiers.

« AUTOMATIC HUMIDITY CONTROL »

## MOISTURE CONTROL

### RECHARGEABLE DEHUMIDIFIER

SKU 1092878 // UPC 661120415794 // CASE PACK 2  
PRODUCT DIMENSIONS 8.5" x 6" x 2.5"



NO ELECTRICITY NEEDED TO USE



INCLUDES CHARGING CORD AND RECHARGES IN 12 HOURS



EASY TO SEE WHEN NEEDS RECHARGING



IDEAL FOR VAULTS AND CLOSETS

The Rechargeable Dehumidifier is perfect for keeping out moisture in your safe or gun room. This compact dehumidifier features water glass crystals that absorb moisture and it has a window that indicates when it's time to recharge. Plugging it into any wall outlet will quickly and easily recharge the crystals so it's ready to use again and again.

« SIMPLY PLUG IN THE DEHUMIDIFIER TO RECHARGE »

## MOISTURE CONTROL

### SILICA GEL CAN - 750G

SKU 222178 // UPC 661120221784 // CASE PACK 4



ABSORBS MOISTURE FROM THE AIR



UP TO 57 CUBIC FEET OF PROTECTION



EASILY RECHARGED IN OVEN



DURABLE, VENTED CAN FOR EASY HANDLING

Lockdown® Silica absorbs moisture from the air inside a vault or storage area preventing condensation, mildew, and rust from damaging valuable firearms. Crystals change color once fully saturated and can be easily recharged in the oven.

« REMOVE MOISTURE FROM THE AIR AGAIN AND AGAIN TO PROTECT YOUR VALUABLES »

## MOISTURE CONTROL

### SILICA GEL PACKET - 450G

SKU 222179 // UPC 661120221791 // CASE PACK 8



ABSORBS MOISTURE FROM THE AIR



PROTECTION FOR UP TO 33 CUBIC FEET



EASILY RECHARGES IN THE OVEN



DURABLE, VENTED BAG FOR EASY HANDLING

Lockdown® Silica absorbs moisture from the air inside a vault or storage area preventing condensation, mildew, and rust from damaging valuable firearms. Crystals change color once fully saturated and can be easily recharged in the oven.

« REMOVE MOISTURE FROM THE AIR AGAIN AND AGAIN TO PROTECT YOUR VALUABLES »

## MOISTURE CONTROL

### SILICA GEL CAN - 40G

SKU 222555 // UPC 661120225553 // CASE PACK 6



ABSORBS MOISTURE FROM THE AIR



IDEAL FOR HANDGUN VAULTS AND AMMO CANS



EASILY RECHARGES IN THE OVEN



SILICA GEL CHANGES FROM ORANGE TO GREEN WHEN RECHARGE IS NEEDED

Lockdown® Silica absorbs moisture from the air inside a vault or storage area preventing condensation, mildew and rust from damaging valuable firearms. Crystals change color once fully saturated and can be easily recharged in the oven.

« REMOVE MOISTURE FROM THE AIR AGAIN AND AGAIN TO PROTECT YOUR VALUABLES »

## MOISTURE CONTROL

### SILICA GEL 5 PACK - 40G

SKU 1138993 // UPC 661120104742 // CASE PACK 4



ABSORBS MOISTURE FROM THE AIR



IDEAL FOR HANDGUN VAULTS AND AMMO CANS



EASILY RECHARGES IN THE OVEN



SILICA GEL CHANGES FROM ORANGE TO BLUE WHEN RECHARGE IS NEEDED

Lockdown® Silica absorbs moisture from the air inside a vault or storage area preventing condensation, mildew, and rust from damaging valuable firearms. Crystals change color once fully saturated and can be easily recharged in the oven. Each bag contains individually wrapped 40g silica bags and each bag contains an indicator card that shows when it's time to recharge. Lockdown silica gel is ideal in everything from vaults to electronics storage. Recharging can be done easily in your home oven.

« REMOVE MOISTURE FROM THE AIR AGAIN AND AGAIN TO PROTECT YOUR VALUABLES »

## MOISTURE CONTROL HYGROMETER

SKU 222111 // UPC 661120221111 // CASE PACK 4



ACCURATE RELATIVE HUMIDITY READINGS 0%-100% INSIDE SAFE



LARGE EASY-TO-READ NUMBERS



MOUNTS EASILY WITH INCLUDED FASTENER

Managing humidity is critical to protecting and preserving the condition of your firearms. The Lockdown® Hygrometer provides accurate relative humidity readings at a glance. Excessive moisture in a vault or storage area can cause rapid corrosion and pitting on metal surfaces. It is important to monitor and control the relative humidity in your storage area to be sure your guns are properly protected.

« PROVIDES ACCURATE RELATIVE HUMIDITY READINGS »

## MOISTURE CONTROL WIRELESS DIGITAL HYGROMETER

SKU 1116792 // UPC 661120080619 // CASE PACK 6



MONITOR TEMP & HUMIDITY FROM BASE UNIT OR REMOTE



MAGNETIC OR FREESTANDING MOUNTS



TRACK MIN/MAX VALUES



ILLUMINATED SCREEN



BATTERY POWERED



WIRELESS REMOTE

Keep your valuables protected from the damaging effects of temperature and humidity with Lockdown® Hygrometers. The state of the art technology shows the current conditions and even records the historical max. and min. values. Use the Wireless Hygrometer with Remote Sensor to keep an eye on conditions inside a vault or cabinet.

« MONITOR TEMPERATURE AND HUMIDITY »

## MOISTURE CONTROL DIGITAL HYGROMETER

SKU 1116774 // UPC 661120080626 // CASE PACK 6



MONITOR TEMP & HUMIDITY



MAGNETIC OR FREESTANDING MOUNTS



TRACK MIN/MAX VALUES



ILLUMINATED SCREEN



BATTERY POWERED

Keep your valuables protected from the damaging effects of temperature and humidity with Lockdown® Hygrometers. The state of the art technology shows the current conditions and even records the historical max. and min. values.

« MONITOR TEMPERATURE AND HUMIDITY »



MOISTURE CONTROL  
**SILICONE GUN SOCKS**

SKU 1099393 // UPC 661120416999 // CASE PACK 10 // 6" X 36" - TACTICAL RIFLE  
 SKU 1099392 // UPC 661120417002 // CASE PACK 10 // 6" X 48" - SCOPED RIFLE  
 SKU 1099391 // UPC 661120416999 // CASE PACK 10 // 4" X 54" - SHOTGUN/RIFLE  
 SKU 1099390 // UPC 661120417019 // CASE PACK 10 // 4" X 14" - PISTOL



- 100% POLYESTER MATERIAL WILL NOT ABSORB MOISTURE
- AVAILABLE IN FOUR SIZES TO FIT NEARLY ANY FIREARM
- SILICONE TREATED FABRIC REPELS MOISTURE TO PREVENT RUST
- PROTECTS AGAINST SCRAPES AND DAMAGE IN STORAGE

Our Silicone Gun Socks are best for keeping unwanted dust, dirt and moisture from damaging your firearm. It protects against rust and any dings, scrapes or bumps that might occur. Our socks are 100% polyester silicone and are available in four different sizes to match your firearm.

« KEEP UNWANTED DUST, DIRT AND MOISTURE FROM DAMAGING YOUR FIREARMS »

MOISTURE CONTROL  
**GOLDEN ROD® DEHUMIDIFIER RODS**

SKU 725721 // UPC 661120257219 // CASE PACK 4 // 12"  
 SKU 725731 // UPC 661120257318 // CASE PACK 4 // 18"  
 SKU 725741 // UPC 661120257417 // CASE PACK 4 // 24"  
 SKU 725751 // UPC 661120257516 // CASE PACK 4 // 36"



- REMOVES MOISTURE FROM THE AIR
- VERMICULITE FILLED
- LIMITED LIFETIME WARRANTY
- PERFECT FOR SAFES AND CLOSETS
- MADE IN USA

The Golden Rod Dehumidifiers work by slightly increasing and maintaining the air temperature inside the gun safe or other enclosure. This allows the warm air to circulate throughout the safe on a continual basis, thus eliminating humidity, mildew, and condensation. All of which are dangerous to your valuable firearm collection. All Golden Rods are filled with 100% Vermiculite to provide even more effective and consistent humidity control.

« ELIMINATE HUMIDITY, MILDEW, AND CONDENSATION »

MOISTURE CONTROL  
**DEHUMIDIFIER RODS**

SKU 1071006 // UPC 661120220008 // CASE PACK 4 // 12"  
 SKU 222010 // UPC 661120220107 // CASE PACK 4 // 18"



- STABILIZES AIR TEMPERATURE
- MOUNTING BRACKETS AND HARDWARE INCLUDED
- PERFECT FOR SMALL SPACES
- EASY INSTALL PLUG ATTACHMENT

The Lockdown® Dehumidifier Rods work by slightly increasing and maintaining the air temperature inside the gun safe or other enclosure. This allows the warm air to circulate throughout the safe on a continual basis, thus eliminating humidity, mildew, and condensation. All of which are dangerous to your valuable firearm collection.

« ELIMINATE MOISTURE AND PROTECT VALUABLES FROM RUST, CORROSION, AND MILDEW »

## MOISTURE CONTROL

### GUNSAVER DEHUMIDIFIER ROD

BY GOLDENROD

SKU 725761 // UPC 6611202257615 // CASE PACK 4 // 12"  
SKU 725771 // UPC 6611202257714 // CASE PACK 4 // 18"



- ✔ PROTECTS FIREARM INVESTMENT
- ✔ MOUNTING BRACKETS INCLUDED
- ✔ 110/220V AC
- ✔ EASY INSTALL PLUG ATTACHMENT

The Gunsaver Dehumidifier Rod works by slightly increasing and maintaining the air temperature inside the gun safe or other enclosure. This allows the warm air to circulate throughout the safe on a continual basis, thus eliminating humidity, mildew, and condensation. All of which are dangerous to your valuable firearm collection.

« ELIMINATE MOISTURE AND PROTECT VALUABLES FROM RUST, CORROSION, AND MILDEW »

## LIGHTING

### AUTOMATIC CORDLESS 25 LED VAULT LIGHT, 2 PACK

SKU 222008 // UPC 661120220084 // CASE PACK 5



- ✔ AUTO ON/OFF LIGHT/MOTION SENSOR
- ✔ 5-METER SENSOR RANGE
- ✔ STRONG MAGNET OR SCREW ATTACHMENT
- ✔ 120° SENSOR ANGLE

The Lockdown® Automatic Cordless 25 LED Vault Lights have a built-in motion sensor that automatically turns the light on when you open the vault and off when you leave. Each light has 25 ultra-bright LED lights to light up all the dark corners of your vault.

« ILLUMINATE AND CUSTOMIZE YOUR VAULT SPACE »

## LIGHTING

### CORDLESS 75 LED - VAULT LIGHT

SKU 222009 // UPC 661120220091 // CASE PACK 5



- ✔ 75-LED WITH 95 LUMENS OUTPUT
- ✔ USES 3 AAA BATTERIES (NOT INCLUDED)
- ✔ STRONG MAGNET OR SCREW ATTACHMENT
- ✔ MOUNT ON WALLS OR SHELVES TO ILLUMINATE DARK CORNERS

The Lockdown® Cordless 75 LED Vault Light has 75 Ultra-Bright LEDs with 95 total lumens output. It runs on 3 AAA batteries and has built in magnetic and screw mounting options. Mount it on walls or shelves to illuminate all the dark corners of your vault.

« ILLUMINATE AND CUSTOMIZE YOUR VAULT SPACE »

## LIGHTING LED VAULT TAPE LIGHT



SKU 1077070 // UPC 661120412892 // CASE PACK 5

- MOTION SENSOR ACTIVATION WITH ADJUSTABLE TIME DELAY
- CUT-TO-LENGTH CAPABILITY
- 3 METERS OF ULTRA-BRIGHT WHITE LEDS
- 1,200 LUMENS OUTPUT

Illuminate and customize your vault space with the Lockdown LED Vault Tape Light. Simple installation and Automatic On/Off make it easy to use. Just plug it in and enjoy a well lit safe when you need it and energy saving when you don't.

« ILLUMINATE AND CUSTOMIZE YOUR VAULT SPACE »

## LIGHTING VAULT LIGHTING KIT



SKU 222020 // UPC 661120220206 // CASE PACK 4  
SKU 222474 // UPC 661120224747 // CASE PACK 4 // 220v

- LED ROPER LIGHT IS DURABLE AND EXTREMELY BRIGHT
- SIMPLE TO INSTALL, MOUNTING HARDWARE INCLUDED
- PROVIDES MAXIMUM ILLUMINATION THROUGHOUT THE ENTIRE VAULT
- POWER CORD WITH ON/OFF SWITCH AND EASY-INSTALL PLUG

The Lockdown® Vault Lighting Kit can be easily installed in any vault and is designed to provide illumination throughout the entire interior. The flexible rope design can be routed to provide superior light coverage regardless of shelf configuration inside the vault. The kit includes a 12' section of super-bright white LED lights housed in a durable clear tube along with a 6' power cord with an in-line on/off switch. A quick install plug allows the power cord to be easily routed through vault wall. Mounting clips and screws provided.

« ILLUMINATE AND CUSTOMIZE YOUR VAULT SPACE »

## LIGHTING LOCKDOWN STEALTH ENTRY LIGHT

SKU 222444 // UPC 661120224440 // CASE PACK 6



- CONVENIENT FOR ADDING EXTRA LIGHT INSIDE A VAULT
- ULTRA BRIGHT 3 LED LIGHT
- BATTERY OPERATED, RUNS ON 3 BUTTON CELL BATTERIES (INCLUDED)
- MAGNETIC BASE AND FLEX HEAD

The Lockdown® Stealth Entry Light is ideal for placement above a combination dial or keypad on your vault, to illuminate it for gaining entry from a dark room. The magnetic base sticks to vault doors while flexible head allows the user to bend and twist the head to the desired position. Rod retains shape and holds the head in place.

« ILLUMINATE AND CUSTOMIZE YOUR VAULT SPACE »

## SECURITY

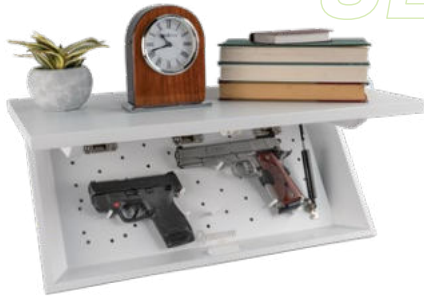

### IN-PLAIN-SIGHT SHELF (WHITE)

SKU 1117247 // UPC 661120080541 // CASE PACK 2  
 PRODUCT DIMENSIONS 24"W x 11.75"H x 3.25"D



### IN-PLAIN-SIGHT SHELF (WALNUT)

SKU 1117248 // UPC 661120080534 // CASE PACK 2  
 PRODUCT DIMENSIONS 24"W x 11.75"H x 3.25"D



EASY STORAGE FOR A VARIETY OF VALUABLES WITH CUSTOMIZABLE PEG SYSTEM



HIDDEN MAGNETIC LATCH FOR QUICK AND SECURE OPENING



AUTOMATIC INTERNAL LED LIGHT FOR VISIBILITY IN LOW LIGHT ENVIRONMENTS

Hide your valuables in-plain-sight with the Lockdown® In-Plain-Sight Shelf. Combined with high-quality construction and a secret magnetic latch that opens a hidden compartment the shelf provides swift, unnoticeable access. The built-in LED light will even let you see valuables in total darkness, plus the shelf is compatible with other Lockdown® Logic™ products like the Lockdown Puck™. Secure your valuables into your everyday lifestyle with hidden in-plain-sight solutions.

**PATS:**  
 AOB.COM/PATENTS

« HIDE YOUR MOST IMPORTANT VALUABLES »

## SECURITY

### KEYED HANDGUN VAULT

SKU 1082263 // UPC 661120414124 // CASE PACK 6 // DIMENSIONS 6.5"W x 10.25"L x 2"D // LARGE  
 SKU 1082264 // UPC 661120414131 // CASE PACK 6 // DIMENSIONS 5.75"W x 8.5"L x 2"D // COMPACT



TUBULAR KEY-LOCK SECURITY



CALIFORNIA D.O.J. APPROVED



LARGE VAULT HOLDS FULL SIZE HANDGUNS



MEETS TSA AIRLINE REQUIREMENTS



HEAVY DUTY ALL STEEL CONSTRUCTION

Store your handgun with confidence using the Lockdown® Handgun Vault. With an ultra-secure lock and a reinforced steel housing, this vault is perfect for home storage. Travel often? Slip the vault into a bag or purse and easily transport from place to place, while always having the key on hand for easy access. This pistol vault is California Department of Justice approved and meets TSA airline requirements.

« STORE YOUR HANDGUN WITH CONFIDENCE »

## SECURITY

### COMBINATION HANDGUN VAULT

SKU 1134157 // UPC 661120104643 // CASE PACK 6 // DIMENSIONS 6.5"W x 10.25"L x 2"D // LARGE  
 SKU 1134158 // UPC 661120104636 // CASE PACK 6 // DIMENSIONS 5.75"W x 8.5"L x 2"D // COMPACT



COMBINATION LOCK



CALIFORNIA D.O.J. APPROVED



LARGE VAULT HOLDS FULL SIZE HANDGUNS



MEETS TSA AIRLINE REQUIREMENTS



HEAVY DUTY ALL STEEL CONSTRUCTION

Keep your firearm secure and at the ready with confidence using the Lockdown® Handgun Vault. With a fast and secure combination lock, you'll never be hunting for keys. Ready for home use or travel this vault is D.O.J. certified and TSA approved. All steel construction ensure this vault will keep your firearms safe so they can keep you safe.

« STORE YOUR HANDGUN WITH CONFIDENCE »



# SECURITY

## 15" CABLE GUN LOCK

SKU 110149 // UPC 661120001645 // CASE PACK 6

- HI-VISIBILITY GREEN FOR INSTANT VERIFICATION
- 30MM KEYED PADLOCK
- 15" REINFORCED CABLE
- INCLUDES 2 KEYS
- APPROVED BY THE CALIFORNIA DEPARTMENT OF JUSTICE

Lockdown® 15" Cable Gun Lock is used to prevent accidents and unauthorized use. It fits most pistols, handguns, rifles, shotguns, and moder sporting rifles. Included are two keys and a padlock for tight security.

**PATS:**  
A0B.COM/PATENTS

« PREVENT ACCIDENTS AND UNAUTHORIZED USE »



# SECURITY

## TRIGGER LOCKS

SKU 1118826 // UPC 661120080725 // CASE PACK 6 // Combination  
 SKU 1118824 // UPC 661120080701 // CASE PACK 10 // Keyed  
 SKU 1118825 // UPC 661120080718 // CASE PACK 6 // Keyed 3 Pack

- HEAVY-DUTY BOLT SECURES THROUGH TRIGGER GUARD
- CALIFORNIA DOJ CERTIFIED
- RUBBERIZED PADS HELP PROTECT FIREARMS
- PROGRAMMABLE COMBINATIONS OR KEY LOCK OPTION

Keep other trigger fingers away from your guns with the Lockdown® Trigger Locks. Keyed and Combination Versions let you pick your protection style and the California Department of Justice Certification give you peace of mind that your guns are always locked down.

**PATS:**  
A0B.COM/PATENTS

« PREVENT ACCIDENTS AND UNAUTHORIZED USE »



# ORGANIZATION

## MAGNUM MAGNET

SKU 1097608 // UPC 61120417040 // CASE PACK 5  
 PRODUCT DIMENSIONS 1.5"W x 6"H x .63"D

## GUN CONCEALMENT MAGNET

SKU 222501 // UPC 661120225010 // CASE PACK 5  
 PRODUCT DIMENSIONS 4.75"W x 1.5"H x .5"D

- RUBBER COATED FOR NON-MARRING OF VALUABLES
- EASILY MOUNTABLE WITH INCLUDED WOOD AND DRYWALL SCREWS
- THE MAGNUM HOLDS 75LBS. FOR HOME DEFENSE SHOTGUNS AND RIFLES
- THE GUN CONCEALMENT MAGNET HOLDS 23LBS. FOR FULL-SIZE PISTOLS & REVOLVERS

The Lockdown® Gun Concealment and Magnum Magnet can be mounted conveniently in a variety of locations to securely hold firearms in place. The powerful magnets easily hold a variety of firearms with their two sizing options. The Gun Concealment Magnet supports full-sized pistols and revolvers and the Magnum Magnet supports pistols and long guns up to 75lbs. A durable rubber coating protects the finish on the gun. The magnets make it perfect for securing a gun out of sight, but within easy reach such as under a desk or nightstand drawer. Multiple magnets can be used to support rifles or shotguns. Organize and store your firearms in a new way with Lockdown's Gun Concealment and Magnum Magnets.

« ORGANIZE AND STORE YOUR FIREARMS »

## ORGANIZATION

### NIGHT GUARDIAN – LOW PROFILE HOLSTER

SKU 110126 // UPC 661120001386 // CASE PACK 6



4.25" WIDE ELASTIC HOLSTER FITS MOST COMPACT TO FULL SIZE FIREARMS



SECURELY MOUNTS IN PLACE WITH NO TOOLS



The Lockdown® Night Guardian Low Profile Holster is made specifically for the person that wants a lower profile bedside holster but wants to maintain the same accessibility as the original Night Guardian Holsters. The Night Guardian Low Profile Holster is made of nylon with reinforced backing for rigidity. The tuckable section can be folded at different depths for holder height adjustment. The 4.25 inch wide elastic holster holds handguns from compact semi-autos to full frame revolvers. This holster was designed for ambidextrous use and has 2 accessory/magazine elastic holsters along the side.

« BE EQUIPPED ANYTIME »

## ORGANIZATION

### NIGHT GUARDIAN – LONG GUN HOLSTER

SKU 222503 // UPC 661120225034 // CASE PACK 5



WAVED BRACKET SECURES NIGHT GUARDIAN IN PLACE BETWEEN THE MATTRESS AND BOX SPRING



KEEPS LONG GUN AND FLASHLIGHT AT THE READY

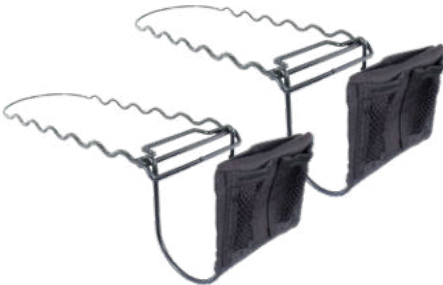

The Lockdown® Night Guardian is an ideal solution for keeping a home defense weapon at the ready in the bedroom. The vinyl coated wire frame fits securely between the bed mattress and box spring and the universal fabric holster holds most any handgun along with a spare magazine and a tactical flashlight. Use one to hold a handgun or double it up to hold a long gun.

« BE EQUIPPED ANYTIME »

## ORGANIZATION

### AR-15 MAGAZINE RACK

SKU 222972 // UPC 661120229728 // CASE PACK 4



ROBUST STEEL FRAME CAN HOLD 10 FULLY LOADED 30 ROUND MAGAZINES



VINYL COATED TO PROTECT MAGAZINES FROM SCRATCHING AND MARRING



COMPATIBLE WITH ALL IN-LINE MAGS FROM 10 ROUND UP TO 30 ROUND



HOLDS UP TO TEN AR-15 MAGAZINES



The Lockdown® Magazine Rack is ideal for keeping AR-15 magazines organized. It conveniently holds up to 10 magazines either loaded or unloaded. It is designed to stand upright on a shelf or any flat surface or it can easily be mounted to a wall or vault door. It is compatible with both mil-spec and polymer mags. Holds any "in line" magazine from 10 round up to 30 round. The vinyl coated steel structure is durable and won't scratch or mar surface finishes.

« THERE IS MORE ROOM IN AN ORGANIZED VAULT »

## ORGANIZATION

### HANDGUN RACK - BARREL DOWN

SKU 1081878 // UPC 661120412717 // CASE PACK 6 // 6 handgun rack  
SKU 222314 // UPC 661120223146 // CASE PACK 6 // 1 handgun rack (3 Pack)



LARGE OVER-MOLDED WIRE CONSTRUCTION HELPS PROTECT AGAINST FIREARM DAMAGE



STABLE DESIGN ALLOWS FOR SECURE USE ON VAULT SHELVES AND SHOOTING BENCHES



FITS .22-.50 CALIBER HANDGUNS

Free up space and keep your handguns instantly accessible with the Lockdown® Handgun Muzzle Rack. This compact pistol rack is the perfect tool for creating room in your vault or even on a range bench. The design allows for confident storage and stability with its over-molded construction and utilizes an upright access design to make your handgun selection process quick and easy.

« THERE IS MORE ROOM IN AN ORGANIZED VAULT »

## ORGANIZATION

### HANDGUN RACK - BARREL UP

SKU 222210 // UPC 661120222101 // CASE PACK 6 // 6 handgun rack  
SKU 222200 // UPC 661120222002 // CASE PACK 6 // 4 handgun rack



VINYL COATING WILL NOT SCRATCH OR MAR HANDGUN'S FINISH



USE AT THE RANGE TO HOLD HANDGUNS WHILE NOT IN USE

The Lockdown® Handgun Racks are vinyl coated metal handgun racks that are extremely handy for use in your gun vault or at the shooting range to provide a safe place to rest your handguns. The individual channels are specially designed to cradle the grip and barrel of the gun and are wide enough to accommodate most wide body pistols or magnum revolvers.

« THERE IS MORE ROOM IN AN ORGANIZED VAULT »

## ORGANIZATION

### STACKABLE HANDGUN RACK

SKU 222504 // UPC 661120225041 // CASE PACK 6



HOLDS 8 HANDGUNS (PISTOLS AND/OR REVOLVERS)



VINYL COATING WON'T SCRATCH OR MAR HANDGUN'S FINISH



USE INDEPENDENTLY OR STACKED

The Lockdown® Handgun Racks are vinyl coated metal handgun racks that are extremely handy for use in your gun vault or at the shooting range to provide a safe place to rest your handguns. The individual channels are specially designed to cradle the grip and barrel of the gun and are wide enough to accommodate most wide body pistols or magnum revolvers.

« THERE IS MORE ROOM IN AN ORGANIZED VAULT »



## ORGANIZATION HANDGUN / AR UPPER HANGER

SKU 222817 // UPC 661120228172 // CASE PACK 5

- HOLDS UP TO 6 HANDGUNS OR 2 AR UPpers
- 3 MOUNTING OPTIONS HARDWARE INCLUDED
- DUAL SIDED

Reclaim unused space in your vault or gun cabinet. The Lockdown® AR Upper Hanger is the perfect addition to the door or free hanging space in your vault. Designed specifically to hold multiple handguns or AR-15 upper assemblies, you can now reclaim floor space where a rifle should go. Dual sided configuration can accommodate 1 upper on one side and 3 handguns on the other.

« THERE IS MORE ROOM IN AN ORGANIZED VAULT »

## ORGANIZATION HANDGUN HANGER

SKU 222172 // UPC 661120221722 // CASE PACK 5



- MOUNTS TO INSIDE OF VAULT DOOR
- FITS MOST HANDGUNS
- HOLDS HANDGUN SECURELY
- UNIVERSAL ATTACHMENT SYSTEM INCLUDED

The universal Handgun Hanger will hold a variety of pistols or revolvers. The wedge shape with open bottom allows the barrel to protrude through. Elastic bands and a rigid back panel provide the structure to hold guns securely in place.

« THERE IS MORE ROOM IN AN ORGANIZED VAULT »

## ORGANIZATION HANGING ORGANIZER, SMALL

SKU 222170 // UPC 661120221708 // CASE PACK 5



- MOUNTS TO INSIDE OF VAULT DOOR
- SECURE AND ORGANIZE YOUR SMALL VALUABLES
- UNIVERSAL ATTACHMENT SYSTEM

The compact size of the Small Hanging Organizer allows it to be easily added to small spaces in any vault. A mesh pocket with an elastic band keeps small valuables secure and easy to access.

« THERE IS MORE ROOM IN AN ORGANIZED VAULT »



## ORGANIZATION

### UNIVERSAL VAULT DOOR ORGANIZER

SKU 222315 // UPC 661120223153 // CASE PACK 5 // Large // 20"W x 12"H  
SKU 222316 // UPC 661120223160 // CASE PACK 5 // Medium // 14"W x 12"H



HEAVY-DUTY STITCHING

BUILT WITH STURDY MESH, NYLON POCKETS SEWN TO A RIGID BACKING

The Lockdown® Universal Vault Door Organizer is perfect for organizing all loose items that tend to clutter the shelves of a vault. With a variety of pocket sizes and configurations it will easily hold handguns, knives, electronics, jewelry or just about any small valuable items. The larger pockets feature zippers that can be opened to allow a handgun barrel to protrude through or closed to contain smaller items. A rigid back panel adds support to the organizer, and mesh pockets make it easy to see contents.

« THERE IS MORE ROOM IN AN ORGANIZED VAULT »

## ORGANIZATION

### MAGNETIC BARREL REST

SKU 222177 // UPC 661120221777 // CASE PACK 4



HOLDS 3 GUNS SECURELY WHEN LEANED AGAINST MAGNETIC SURFACE

RUBBER-BACKED MAGNET PROTECTS VAULT'S FINISH

OVER-MOLDED RUBBER CONTACT POINTS PROTECT FIREARM'S FINISH

Accessing a gun deep in the back of a vault can be challenging. Rather than learning to juggle an armful of guns, just use the Lockdown® Magnetic Barrel Rest. It conveniently secures to the outside of any vault and provides a perfect staging location. Rubberized holders keep your gun secure and protect your gun's finish.

« THERE IS MORE ROOM IN AN ORGANIZED VAULT »

## ORGANIZATION

### VAULT DRAWER

SKU 222155 // UPC 661120221555 // CASE PACK 3  
PRODUCT DIMENSIONS 14"L x 14"W x 4"D



QUICKLY ATTACHES TO ANY VAULT SHELF

HOLDS UP TO 25LB

EASY INSTALL—NO TOOLS NEEDED

The Lockdown® Vault Drawer mounts underneath a vault shelf to instantly add previously unused space. Perfect for a variety of valuables and documents.

« THERE IS MORE ROOM IN AN ORGANIZED VAULT »

## ORGANIZATION WIPEDOWN KIT

SKU 222162 // UPC 661120221623 // CASE PACK 3



PROTECT THE FINISH OF YOUR GUNS



KEEPS OIL, BRUSH AND RAGS HANDY



WIPE OFF FINGERPRINTS BEFORE STORAGE



UNIVERSAL ATTACHMENT SYSTEM INCLUDES HOOKS AND MAGNETS

« PROTECT THE FINISH OF YOUR GUNS »

## ORGANIZATION VAULT ACCESSORY DELUXE KIT

SKU 222498 // UPC 661120224983 // CASE PACK 4



### INCLUDES:

- 12" Dehumidifier Rod Eliminates moisture and protects from rust, corrosion and mildew which is harmful for all firearm collections.
- Large Hanging Organizer makes great use of the lost space on the door, letting you hang handguns, magazines and knives. Universal Attachment System lets you hang the organizer on both carpeted or bare metal interiors.
- Hygrometer is great for visually monitoring the humidity level inside your safe.
- Automatic Cordless Vault Light allows you to illuminate exactly where more light is needed.
- Magnetic Barrel Rest provides a safe place for your firearms while accessing your safe.
- Vault Anchor Bolts rigidly secure your safe to floor or studs in the wall for an extra level of protection.

« THERE IS MORE ROOM IN AN ORGANIZED VAULT »

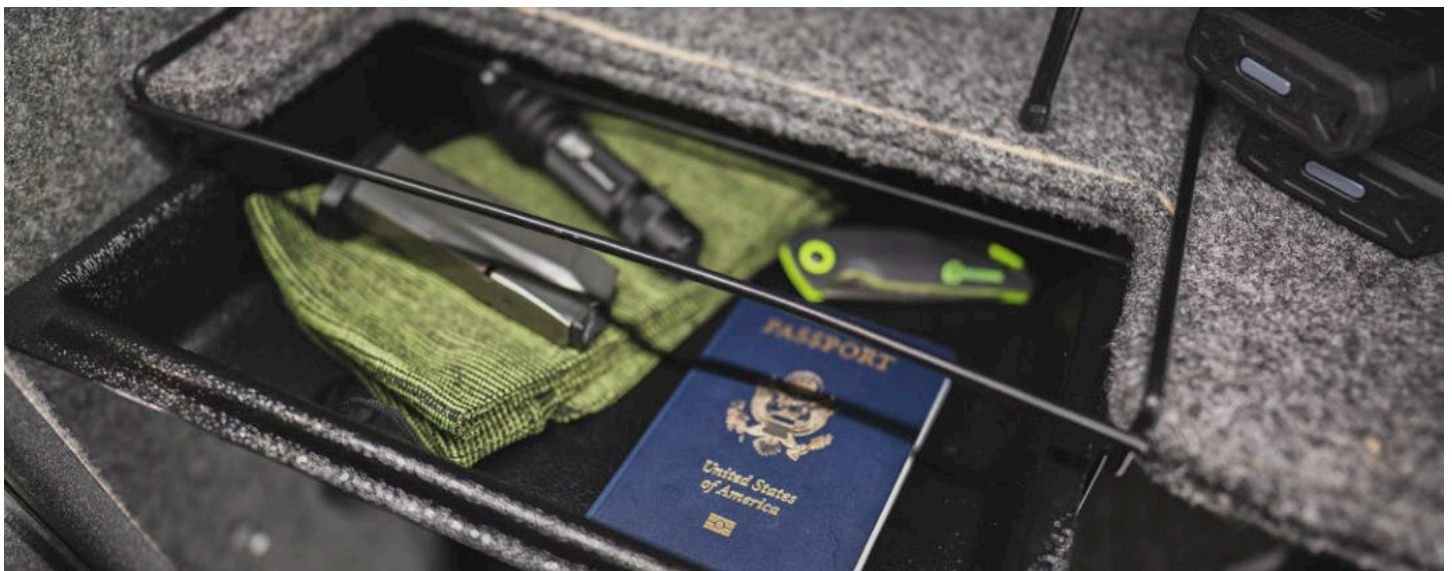

 **BOG**<sup>®</sup>

**2023 NEW PRODUCTS**





## VIGILANT™

### BINO BIVY

ITEM - 1159187 • UPC - 661120651833

- Soft shell exterior with fleece lining
- Fits all binoculars up to 15 x 56mm
- YKK® zippers
- Lightweight heavy-duty buckles
- Front rangefinder pocket
- Back zippered mesh tag/phone pocket
- Hypalon-reinforced cinched Molle straps for additional gear securement
- Padded shoulder strap with spacer mesh
- Elastic side pouch for extra ammunition, calls, etc.
- Detachable cleaning cloth



## KINETIC™

### LIGHTWEIGHT DAY PACK

ITEM - 1159182 • UPC - 661120651857

- Removable DeathGrip®/gun/bow carry boot included
- Compression straps secure a DeathGrip® tripod and other gear
- Durable 420D ripstop nylon fabric
- YKK® zippers
- Lightweight heavy-duty buckles
- 2400 cubic inch capacity
- Durable ripstop nylon rain cover included
- Hypalon-reinforced cinched Molle straps for additional gear securement
- Hydration compatible



## AGILITY™

### STAY DAY PACK

ITEM - 1159183 • UPC - 661120651819

- Removable DeathGrip®/gun/bow carry boot included
- Compression straps secure a DeathGrip® tripod and other gear
- Durable 420D ripstop nylon fabric
- YKK® zippers
- Lightweight heavy-duty buckles
- 2900 cubic inch capacity
- Lightweight, durable aluminum stay for additional support/breathability
- Durable ripstop nylon rain cover included
- Hypalon-reinforced cinched Molle straps for additional gear securement
- Hydration compatible



## ULTIMATUM™

### LUMBAR FANNY

ITEM - 1159190 • UPC - 661120651840

- Compression straps secure a DeathGrip® tripod and other gear
- Durable 420D ripstop nylon fabric
- YKK® zippers
- Lightweight heavy-duty buckles
- 1100 cubic inch capacity
- Large main compartment with lower gear pocket
- Water bottle pouches and vertical gear pockets
- Durable ripstop nylon rain cover included
- Padded EVA waist belt with dual hip pockets
- Padded shoulder strap with adjustable sternum strap
- Hypalon-reinforced cinched Molle straps for additional gear securement



## INCEPTION™ M/L

### BACKPACK FRAME

ITEM - 1192671 • UPC - 661120654513

- Durable 420D ripstop nylon fabric
- YKK® zippers
- Lightweight heavy-duty buckles
- Quick attach buckle system is compatible with all BOG® Helix™ bags
- Carbon fiber frame
- Padded waist belt with hip pockets
- Load lifters and compression straps secure loads and keep weight centered
- Internal meat shelf
- Adjustable sternum strap
- Hypalon-reinforced cinched Molle straps for additional gear securement
- Fits 28"-36" waist sizes



## INCEPTION™ XL

### BACKPACK FRAME

ITEM - 1159185 • UPC - 661120651826

- Durable 420D ripstop nylon fabric
- YKK® zippers
- Lightweight heavy-duty buckles
- Quick attach buckle system is compatible with all BOG® Helix™ bags
- Carbon fiber frame
- Padded waist belt with hip pockets
- Load lifters and compression straps secure loads and keep weight centered
- Internal meat shelf
- Adjustable sternum strap
- Hypalon-reinforced cinched Molle straps for additional gear securement
- Fits 34"-44" waist sizes



## HELIX™ 6000

### BIVY BAG

ITEM - 1159189 • UPC - 661120651703

Removable DeathGrip®/gun/bow carry boot included

Compression straps secure a DeathGrip® tripod and other gear

Durable 420D ripstop nylon fabric

YKK® zippers

Lightweight heavy-duty buckles

Quick attach buckle system is compatible with BOG® Inception™ backpack frame

6000 cubic inch capacity

Roll-top design with guide lid included

Large, full opening main compartment with lower zip pocket allowing access to gear at the bottom of the bag

Durable ripstop nylon rain cover included

Hypalon-reinforced cinched Molle straps for additional gear securement

Hydration compatible



## HELIX™ 3500

### BIVY BAG

ITEM - 1159191 • UPC - 661120651697

Removable DeathGrip®/gun/bow carry boot included

Compression straps secure a DeathGrip® tripod and other gear

Durable 420D ripstop nylon fabric

YKK® zippers

Lightweight heavy-duty buckles

Quick attach buckle system is compatible with BOG® Inception™ backpack frame

3500 cubic inch capacity

Large, full opening main compartment with lower zip pocket allowing access to bottom of bag gear

Durable ripstop nylon rain cover included

Hypalon-reinforced cinched Molle straps for additional gear securement

Hydration compatible



## INCEPTION™ M/L & HELIX™ 3500

### BACKPACK FRAME + BIVY BAG

ITEM - 1200280 • UPC - 661120747123

Removable DeathGrip®/gun/bow carry boot included

Compression straps secure a DeathGrip® tripod and other gear

Durable 420D ripstop nylon fabric

YKK® zippers

Lightweight heavy-duty buckles

Quick attach buckle system

Carbon fiber frame

Padded waist belt with hip pockets

Load lifters and compression straps secure loads and keep weight centered

Internal meat shelf

Adjustable sternum strap

Hypalon-reinforced cinched Molle straps for additional gear securement

3500 cubic inch capacity

Large, full opening main compartment with lower zip pocket allowing access to bottom of bag gear

Durable ripstop nylon rain cover included

Hydration compatible

Fits 28"-36" waist sizes



## INCEPTION™ XL & HELIX™ 3500

### BACKPACK FRAME + BIVY BAG

ITEM - 1200284 • UPC - 661120747635

Removable DeathGrip®/gun/bow carry boot included  
 Compression straps secure a DeathGrip® tripod and other gear  
 Durable 420D ripstop nylon fabric  
 YKK® zippers  
 Lightweight heavy-duty buckles  
 Quick attach buckle system  
 Carbon fiber frame  
 Padded waist belt with hip pockets  
 Load lifters and compression straps secure loads and keep weight centered

Internal meat shelf  
 Adjustable sternum strap  
 Hypalon-reinforced cinched Molle straps for additional gear securement  
 3500 cubic inch capacity  
 Large, full opening main compartment with lower zip pocket allowing access to bottom of bag gear  
 Durable ripstop nylon rain cover included  
 Hydration compatible  
 Fits 34"-44" waist sizes



## INCEPTION™ M/L & HELIX™ 6000

### BACKPACK FRAME + BIVY BAG

ITEM - 1200288 • UPC - 661120747642

Removable DeathGrip®/gun/bow carry boot included  
 Compression straps secure a DeathGrip® tripod and other gear  
 Durable 420D ripstop nylon fabric  
 YKK® zippers  
 Lightweight heavy-duty buckles  
 Quick attach buckle system  
 Carbon fiber frame  
 Padded waist belt with hip pockets  
 Load lifters and compression straps secure loads and keep weight centered

Internal meat shelf  
 Adjustable sternum strap  
 Hypalon-reinforced cinched Molle straps for additional gear securement  
 6000 cubic inch capacity  
 Roll-top design with guide lid included  
 Large, full opening main compartment with lower zip pocket allowing access to gear at the bottom of the bag  
 Durable ripstop nylon rain cover included  
 Hydration compatible  
 Fits 28"-36" waist sizes



## INCEPTION™ XL & HELIX™ 6000

### BACKPACK FRAME + BIVY BAG

ITEM - 1200292 • UPC - 661120747659

Removable DeathGrip®/gun/bow carry boot included  
 Compression straps secure a DeathGrip® tripod and other gear  
 Durable 420D ripstop nylon fabric  
 YKK® zippers  
 Lightweight heavy-duty buckles  
 Quick attach buckle system  
 Carbon fiber frame  
 Padded waist belt with hip pockets  
 Load lifters and compression straps secure loads and keep weight centered

Internal meat shelf  
 Adjustable sternum strap  
 Hypalon-reinforced cinched Molle straps for additional gear securement  
 6000 cubic inch capacity  
 Roll-top design with guide lid included  
 Large, full opening main compartment with lower zip pocket allowing access to gear at the bottom of the bag  
 Durable ripstop nylon rain cover included  
 Hydration compatible  
 Fits 34"-44" waist sizes



## M-LOK RAIL

### 3" ARCA SWISS® RAIL

ITEM - 1191920 • UPC - 661120655213

Durable, lightweight aluminum construction

Fits standard M-Lok forends and adapters

Designed for use in:

- BOG® DeathGrip® Infinite and Sherpa Tripods
- All tripods utilizing the Arca Swiss® mounting system

Weighs 1.28 oz



## M-LOK RAIL

### 12" ARCA SWISS® RAIL

ITEM - 1196120 • UPC - 661120655220

Durable, lightweight aluminum construction

Fits standard M-Lok forends and adapters

4 connection points for maximum versatility and stability

Designed for use in:

- BOG® DeathGrip® Infinite and Sherpa Tripods
- All tripods utilizing the Arca Swiss® mounting system

Weighs 3.5 oz



VERSATILE MOUNT SYSTEM



## DEATHGRIP® INFINITE

### ALUMINUM

ITEM - 1159188 • UPC - 661120999782

**NEW!** Quick-release Arca-Swiss® mount system for optic and shooting system interchangeability

**NEW!** Low-profile ball head with 360° rotation & 180° tilt

**NEW!** Twist-lock legs for easy, secure height adjustment

**NEW!** Hub mounted gear hook to steady tripod

**NEW!** Included optics mounting plate

**NEW!** Proprietary rubber feet with removable steel spikes

**NEW!** Included padded carry case

Durable large diameter aluminum legs

Deathgrip® clamping head with non-marring jaws

3-Position leg angle locks (20°, 45° & 85°)

Prone to standing height adjustment

Integral bubble level





 PATS: aob.com/patents

## DEATHGRIP® INFINITE

**CARBON FIBER**

ITEM - 1163389 • UPC - 661120999799

Quick-release Arca-Swiss® mount system for optic and shooting system interchangeability

Low-profile ball head with 360° rotation & 180° tilt

Twist-lock legs for easy, secure height adjustment

Hub mounted gear hook to steady tripod

Included optics mounting plate

Proprietary rubber feet with removable steel spikes

Included padded carry case

Lightweight large-diameter carbon fiber legs

Deathgrip® Ultralite clamping head with non-marring jaws

3-Position leg angle locks (20°, 45° & 85°)

Prone to standing height adjustment

Integral bubble level



 PATS: aob.com/patents

## DEATHGRIP® SHERPA

**LIGHTWEIGHT CARBON FIBER TRIPOD**

ITEM - 1168229 • UPC - 661120999805

Quick-release Arca-Swiss® mount system for optic and shooting system interchangeability

Low-profile ball head with 360° rotation & 180° tilt

Twist-lock legs for easy, secure height adjustment

Removable center post for micro height adjustment

Center post mounted gear hook to steady tripod

Included optics mounting plate

Proprietary rubber feet with removable steel spikes

Included padded carry case

Premium lightweight carbon fiber legs

Deathgrip® Ultralite clamping head with non-marring jaws

3-Position leg angle locks (20°, 45° & 85°)

Prone to standing height adjustment

Included padded carry case



## TRIPOD CARRY BAG

ITEM - 1181582 • UPC - 661120999812

PU coated 600D polyester construction

Padded interior for tripod protection

Side pouch for additional optic plates

Carry handles with padded shoulder strap

Comfortable T-handle zipper pull

Works with any existing aluminum or carbon fiber DeathGrip®

 **BOG**<sup>®</sup>

**RETURNING PRODUCTS**





 PATS: aob.com/patents

## CAMO DEATHGRIP®

**MOSSY OAK® - BOTTOMLAND®**

ITEM - 1164398 • UPC - 661120265238

- Prone to standing height adjustment
- Lever leg locks for secure, easy adjustment
- Proprietary, center-of-gravity alignment dual action clamping DeathGrip® head with non-marring jaw inserts
- 25° of cant adjustment
- 360° pan with tension adjustment
- Integral bubble level
- Retractable steel foot spikes
- Mossy Oak® Bottomland® camo
- Large-Diameter Aluminum Legs
- Weighs 8.5 lbs



 PATS: aob.com/patents

## CAMO DEATHGRIP®

**REALTREE EXCAPE®**

ITEM - 1134446 • UPC - 661120103813

- Prone to standing height adjustment
- Lever leg locks for secure, easy adjustment
- Proprietary, center-of-gravity alignment dual action clamping DeathGrip® head with non-marring jaw inserts
- 25° of cant adjustment
- 360° pan with tension adjustment
- Integral bubble level
- Retractable steel foot spikes
- REALTREE EXCAPE® camo
- Large-Diameter Aluminum Legs
- Weighs 8.5 lbs



Premium carry bag included.

 PATS: aob.com/patents

## GRAVE DIGGER™

**MOSSY OAK ELEMENTS TERRA® GROUND BLIND**

ITEM - 1147441 • UPC - 661120107194

- Proprietary StealthZip® silent zipper
- StealthTrac® silent window system
- 6'1" standing height
- Easy 4-hub pop-up design
- 600D polyester fabric with UV protection
- 360° curtain window system
- 70° shooting width
- 9" nail stakes included
- Mossy Oak Elements Terra® camo
- Dimensions 83" x 83" x 73"



## GRAVE DIGGER™

### REALTREE EXCAPE® GROUND BLIND

ITEM - 1147440 • UPC - 661120107187

- Proprietary StealthZip® silent zipper
- StealthTrac® silent window system
- 6'1" standing height
- Easy 4-hub pop-up design
- 600D polyester fabric with UV protection
- 360° curtain window system
- 70° shooting width
- 9" nail stakes included
- REALTREE EXCAPE® camo
- Dimensions 83" x 83" x 73"



## PREVAIL™

### REALTREE EXCAPE® GROUND BLIND

ITEM - 1134435 • UPC - 661120103752

- Proprietary StealthZip® silent zipper
- StealthTrac® silent window system
- 360° curtain windows
- 600D polyester fabric w/ UV protection
- 5-hub design comfortably fits 2 hunters
- 360° brush loops for ultimate concealment
- Sitting height design
- 9" nail stakes
- Dimensions - 59" x 59" x 63"
- Mossy Oak Elements Terra® camo



## PREVAIL™

### REALTREE EXCAPE® GROUND BLIND

ITEM - 1134434 • UPC - 61120103745

- Proprietary StealthZip® silent zipper
- StealthTrac® silent window system
- 360° curtain windows
- 600D polyester fabric w/ UV protection
- 5-hub design comfortably fits 2 hunters
- 360° brush loops for ultimate concealment
- Sitting height design
- 9" nail stakes
- Dimensions - 59" x 59" x 63"
- REALTREE EXCAPE® camo



 PATS: [aob.com/patents](http://aob.com/patents)

## HAYMAKER®

### BALE GROUND BLIND

ITEM - 1116634 • UPC - 661120080381

- 600D field khaki fabric with UV protection
- Full coverage brush loops
- Curtain windows and mesh
- StealthTrac® silent window system
- Easy to assemble steel frame
- Waterfowl trap door ideal for finishing waterfowl
- Rebar-style staking system
- Snap style cover for easy setup and removal
- Dimensions - 64.25" x 83.9" x 71.7"



## SNOOD™ SEAT

### CAMO TURKEY CHAIR - MOSSY OAK®

ITEM - 1134444 • UPC - 661120103806

- Steel frame construction
- Easy fold-up design
- Comfortable textilene fabric
- 300 lb weight capacity
- Weighs 6.5 lbs
- MOSSY OAK OBSESSION® camo



## TRIPLE PLAY®

### GROUND BLIND CHAIR

ITEM - 1117130 • UPC - 661120080411

- Lightweight aluminum frame construction
- Heavy-duty textilene fabric construction
- Extended seat area for maximum comfort
- Sewn-in accessory pouch
- Carry strap
- Weighs 4.5 lbs
- Weight capacity: 250lbs



## 4 ON THE FLOOR®

### GROUND BLIND CHAIR

ITEM - 1117129 • UPC - 661120080404

- Lightweight aluminum frame construction
- Heavy-duty textilene and nylon fabric construction
- Extended seat height for use in all blinds
- Extended seat area for maximum comfort
- Weighs 5.5 lbs
- Weight capacity: 300 lbs



Legs fold and store in pouch under seat

## NUCLEUS™ 360

### GROUND BLIND CHAIR

ITEM - 1115809 • UPC - 661120080398

- Lightweight aluminum frame construction
- Extendable leg height
- Comfortable, heavy-duty textilene fabric construction
- Extended seat area for maximum comfort
- 4-leg design for ultimate stability
- Weight capacity: 400 lbs
- Weighs 8 lbs



## DEATHGRIP® 360

### SHOOTING REST CHAIR

ITEM - 1134447 • UPC - 661120103820

- Lightweight aluminum frame construction
- Proprietary DeathGrip® clamping head with a center-post attachment
- Extendable leg height
- Comfortable, heavy-duty textilene fabric construction
- Extended seat area for maximum comfort
- 4-leg design for ultimate stability
- Weight capacity: 400 lbs



## CLANDESTINE®

### INVISIBLE FLASH GAME CAMERA

ITEM - 1116327 • UPC - 661120080152

- 18MP with FHD (1080P) video
- .04 second trigger speed/.6 second recovery
- 100' flash range/80' detection range
- Removable Dominion™ menu/viewer with 3" color TFT screen
- Temp/date/time/baro pressure/moon phase image stamps
- Multi-shot and time lapse modes
- Intuitive icon based camera setup
- Low glow IR flash



## BLOOD MOON®

### DUAL SENSOR GAME CAMERA

ITEM - 1116328 • UPC - 661120080169

- 22MP with FHD (1080P) video
- Dual image sensor
- .04 second trigger speed/.6 second recovery
- 120' flash range/100' detection range
- Removable Dominion™ menu/viewer with 3" color TFT screen
- Temp/date/time/baro pressure/moon phase image stamps
- Multi-shot and time lapse modes
- Intuitive icon based camera setup
- Red glow IR flash



## DOMINION®

### GAME CAMERA MENU/IMAGE SCREEN

ITEM - 1116334 • UPC - 661120080497

- Removable menu with 3" TFT color screen
- Icon based menu for easy setup
- 3" full color viewing screen with zoom function
- Battery and SD storage
- Animal tagging technology
- Removable menu is ideal for properly aligning game camera



## OMNIPOTENCE®

### RECHARGEABLE BATTERY PACK

ITEM - 1116329 • UPC - 661120080480

- Rechargeable for continuous use
- Battery level indicator
- Approximate battery life 23,000 images
- Micro USB Charging Port
- 6 hour charge time
- 1 year estimated runtime

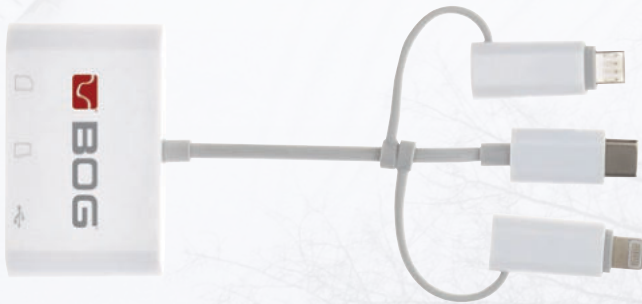

## BOG CAMERA CARD READER

### CAMERA ACCESSORIES

ITEM - 1131488 • UPC - 661120103318

- Ability to read SD and Micro SD cards
- Compatible with iPhone, Android, Windows, and Apple
- Comes with micro USB, USB-C and Lightning adapter
- Plug and play operation. No app needed.



## FIELD GENERAL®

### STEP-IN GAME CAMERA MOUNT

ITEM - 1112787 • UPC - 661120080459

- Durable steel frame construction
- Tri-leg design for maximum stability
- Ball head design for easy and secure camera placement
- Total height: 25.5" Collapsed (53" Extended)





## FARMHAND®

### T-POST GAME CAMERA MOUNT

ITEM - 1112785 • UPC - 661120080442

- Durable aluminum construction
- Adjustable knob tension for universal post securement
- Ball head design for easy and secure camera placement



## CONSTICTOR®

### RATCHET GAME CAMERA MOUNT

ITEM - 1112786 • UPC - 661120080435

- Durable aluminum construction
- Ratchet strap securement design
- Strap length: 78"
- Max tree diameter: 2'
- Ball head design for easy and secure camera placement



## TUNNEL VISION®

### AUGER GAME CAMERA MOUNT

ITEM - 1112784 • UPC - 661120080428

- Durable aluminum construction
- Aggressive-bite tree auger
- Ball head design for easy and secure camera placement



 PATS: [aob.com/patents](http://aob.com/patents)

## DEATHGRIP®

### ALUMINUM PRECISION TRIPOD

ITEM - 1099442 • UPC - 661120416692

- Engineered to be the most stable shooting platform for its price point
- Durable, aluminum construction
- Secures any weapon for hands-free use
- Integral bubble level
- Retractable steel spikes secure into virtually any terrain
- 3-position leg lock for prone, kneeling, sitting and standing positions
- Weighs 8.5lbs



 PATS: [aob.com/patents](http://aob.com/patents)

## DEATHGRIP®

### CARBON FIBER PRECISION TRIPOD

ITEM - 1099443 • UPC - 661120416708

- Engineered to be the most stable shooting platform on the market
- Carbon fiber legs are 20% lighter and 6x stronger than aluminum legs
- Secures any weapon for hands-free use
- Integral bubble level
- Retractable steel spikes secure into virtually any terrain
- 3-position leg lock for prone, kneeling, sitting and standing positions
- Weighs 7.5lbs



 PATS: [aob.com/patents](http://aob.com/patents)

## DEATHGRIP® ULTRA LITE

### CLAMPING TRIPOD HEAD

ITEM - 1117132 • UPC - 661120079057

- Magnesium construction
- Fits sporter rifles, quad-rail AR platforms and crossbows
- Arca Swiss® compatible
- Switcheroo® compatible
- 1/4"-20 or 3/8"-16 threaded mounting holes
- Weighs less than 1 lb
- Non-marring rubber inserts
- Patent-pending dual jaw closure design



## GREAT DIVIDE®

### TRIPOD HEAD

ITEM - 1117185 • UPC - 661120080503

- Durable aluminum construction
- Ultra-smooth head design
- Arca Swiss® compatible
- Weighs less than 1lb
- Ambidextrous handle
- Attaches via 1/4-20 or 3/8-16 stud
- Comes with 1 Arca Swiss plate
- Micro-adjustments up to 60° tilt and 360° pan



## DEATHGRIP® ULTRA LITE & GREAT DIVIDE®

### TRIPOD HEAD COMBO

ITEM - 1137118 • UPC - 661120106487

- Magnesium constructed DeathGrip® UltraLite Head
- Arca Swiss®, Switcheroo® and 1/4-20, 3/8-16 compatible
- Dual-adjustment DeathGrip® clamping head with non-marring jaw inserts
- Aluminum constructed Great Divide® head
- 360° pan with tension adjustment
- Ultra-smooth tilt functionality
- Ambidextrous handle
- Designed to fit the BOG® Adrenaline® pods

 PATS: [aob.com/patents](http://aob.com/patents)



## DEATHGRIP® ELEVATION

### HUNTING REST

ITEM - 1116643 • UPC - 661120079064

- Lightweight rugged construction
- Fits sporter rifles, quad-rail AR platforms and crossbows
- Tri-arm design for maximum shooting range of motion
- Quiet tree strap securement
- Non-marring rubber jaws
- Patent-pending dual jaw closure design
- Secondary clamp strap for additional security

 PATS: [aob.com/patents](http://aob.com/patents)



## DEATHGRIP<sup>®</sup> ELEVATION

### MOUNTING BRACKET

ITEM - 1124326 • UPC - 661120103226

- Lightweight Rugged Construction
- Oversized Ratchet Strap with Nylon Web Strapping
- Cam-Over Level Adjustment
- Quick-Release Arm Locks
- Quick-Release Height Micro Adjust



## HAVOC<sup>™</sup>

### TRIPOD

ITEM - 1100479 • UPC - 661120418269

- Highly portable shooting platform
- Durable, aluminum construction
- Quick, twist lock leg deployment
- Adjusts from sitting to kneeling shooting positions



## CAMO HAVOC<sup>™</sup>

### VEIL ALPINE GREEN CAMO TRIPOD

ITEM - 1100485 • UPC - 661120418382

- Highly portable shooting platform
- Durable, aluminum construction
- Quick, twist lock leg deployment
- Adjusts from sitting to kneeling shooting positions



## HAVOC™

### BIPOD

ITEM - 1100478 • UPC - 661120418252

- Highly portable shooting platform
- Durable, aluminum construction
- Quick, twist lock leg deployment
- Adjusts from sitting to kneeling shooting positions



## CAMO HAVOC™

### VEIL ALPINE GREEN CAMO BIPOD

ITEM - 1100484 • UPC - 661120418375

- Highly portable shooting platform
- Durable, aluminum construction
- Quick, twist lock leg deployment
- Adjusts from sitting to kneeling shooting positions



## HAVOC™

### MONOPOD

ITEM - 1100477 • UPC - 661120418245

- Highly portable shooting platform
- Durable, aluminum construction
- Quick, twist lock leg deployment
- Adjusts from sitting to kneeling shooting positions

ENGINEERED FOR THE UNKNOWN



## ADRENALINE®

### TRIPOD

ITEM - 1100482 • UPC - 661120418412

- Engineered for portability and versatility
- Durable, aluminum construction
- Patented USR shooting yoke
- Patented Switcheroo® mounting system
- Retractable steel spikes secure into virtually any terrain
- Adjusts from sitting to standing shooting positions



## CAMO ADRENALINE®

### VEIL ALPINE GREEN CAMO TRIPOD

ITEM - 1100488 • UPC - 661120418443

- Engineered for portability and versatility
- Durable, aluminum construction
- Patented USR shooting yoke
- Patented Switcheroo® mounting system
- Retractable steel spikes secure into virtually any terrain
- Adjusts from sitting to standing shooting positions



## ADRENALINE®

### BIPOD

ITEM - 1100481 • UPC - 661120418405

- Engineered for portability and versatility
- Durable, aluminum construction
- Patented USR shooting yoke
- Patented Switcheroo® mounting system
- Retractable steel spikes secure into virtually any terrain
- Adjusts from sitting to standing shooting positions



## CAMO ADRENALINE®

### VEIL ALPINE GREEN CAMO BIPOD

ITEM - 1100487 • UPC - 661120418436

- Engineered for portability and versatility
- Durable, aluminum construction
- Patented USR shooting yoke
- Patented Switcheroo® mounting system
- Retractable steel spikes secure into virtually any terrain
- Adjusts from sitting to standing shooting positions



## ADRENALINE®

### MONOPOD

ITEM - 1100480 • UPC - 661120418399

- Great for shooting and hiking
- Durable, aluminum construction
- Patented USR shooting yoke
- Compatible with Switcheroo® mounting system
- Retractable steel spikes secure into virtually any terrain
- Adjusts from sitting to standing shooting positions



## CAMO ADRENALINE®

### VEIL ALPINE GREEN CAMO MONOPOD

ITEM - 1100486 • UPC - 661120418429

- Great for shooting and hiking
- Durable, aluminum construction
- Patented USR shooting yoke
- Patented Switcheroo® mounting system
- Retractable steel spikes secure into virtually any terrain
- Adjusts from sitting to standing shooting positions



 PATS: [aob.com/patents](http://aob.com/patents)

## RAPID SHOOTING REST

ITEM - 110113 • UPC - 66112001256

- Deployed shooting height adjusts from 7"-11"
- Diecast aluminum construction
- Universal shooting rest rotates 360°
- Collapses for transport
- Non-marring, non-slip rubber feet
- Works with any BOG® with Switcheroo® platform
- Weights 21.6oz



## DEAD SILENT STICKS

STANDING SHOOTING STICKS

ITEM - 735565 • UPC - 729806355656

- 72" usable height
- Durable 9/16" diameter aluminum tubing
- Elastic strap keeps collapsed sticks bound and quiet for transport
- Weights 16 oz



## DEAD SILENT STICKS

SITTING SHOOTING STICKS

ITEM - 735560 • UPC - 729806355601

- 39" usable height
- Durable 9/16" diameter aluminum tubing
- Elastic strap keeps collapsed sticks bound and quiet for transport
- Weights 11oz





## FIELDPOD®

### HUNTING REST

ITEM - 1100471 • UPC - 661120418467

- Supports shotguns, rifles and crossbows
- Portable, collapses quickly for transportation
- Overmolded, non-marring front and rear supports
- Lightweight, durable aluminum construction
- Adjusts from sitting to kneeling shooting positions



## FIELDPOD® MAX

### HUNTING REST

ITEM - 1100473 • UPC - 661120418474

- Supports shotguns, rifles and crossbows
- Independent leg adjustment
- Integral bubble level for upper frame
- Ultra-stable, dual-frame aluminum construction
- Adjusts from sitting to kneeling shooting positions
- Cast aluminum hub allows for secure, smooth 360° rotation



## FIELDPOD® MAGNUM

### HUNTING REST

ITEM - 1100474 • UPC - 661120418481

- Supports shotguns, rifles and crossbows
- Independent leg adjustment
- Integral bubble level for upper frame
- Ultra-stable, dual-frame aluminum construction
- Adjusts from sitting to standing shooting positions
- Cast aluminum hub allows for secure, smooth 360° rotation



## CHAIRPOD™

### HUNTING REST

ITEM - 1100475 • UPC - 661120418498

- Supports shotguns, rifles and crossbows
- Swing-arm system and 360° silent swivel chair allows for maximum range of movement
- Overmolded, non-marring front and rear supports
- Great for hunting from ground blinds, field edges or shooting at the range
- Durable steel-frame construction supports up to 300lbs
- Up to 41" vertical adjustment
- Integrated shoulder carry strap included



## TREEPOD™

### HUNTING REST

ITEM - 1100476 • UPC - 661120418504

- Fully supports shotguns, rifles and crossbows
- Anodized aluminum and powder coated steel construction
- Overmolded, non-marring rear and front rests
- Safety gun retention strap included
- Upper frame and swing-arm easily detach for compact transport
- Universal attachment base included



## PROFESSIONAL CAMERA ADAPTER

### ACCESSORIES

ITEM - 735546 • UPC - 729806355465

- Pistol-grip style ball head allows for one-handed operation
- Omni-directional ball for multi-direction rotation and tilt
- Accessory plate has 1/4"-20 and 3/8"-16 thread bushings
- Integral bubble level
- Side lever to lock rotation
- Weighs 21 oz



## BINOCULAR REST

### ACCESSORIES

ITEM - 735547 • UPC - 729806355472

- High-strength, lightweight ABS plastic
- Non-slip rubber-covered platform
- Includes a 3/8"-16 thread and 1/4"-20 size bushing
- 3 1/4" deep x 6" wide x 3/4" tall
- Weighs 7 oz



## CAMERA ADAPTER

### ACCESSORIES

ITEM - 735549 • UPC - 729806355496

- Omni-directional ball for multi-direction rotation and tilt
- Top lever release lock to prevent accidental lever release
- Accessory plate has 1/4"-20 and 3/8"-16 thread bushings to fit most mounts
- Integral bubble level
- Weighs 14oz



## SPOTTING SCOPE ADAPTER

### ACCESSORIES

ITEM - 735561 • UPC - 729806355618

- Base is compatible with the Universal Shooting Rest
- Head detaches to fit on any BOG® shooting pod
- Accessory plate is 1 5/8" x 2" in size and fits most common camera mounts
- Integral bubble level
- Adjustable tilt and 360° rotation
- 3/16"-24" and 1/4"-20" thread bushings
- Includes weather resistant carry bag with allen wrench for adjustments



## SLING SWIVEL MOUNT

ITEM - 735562 • UPC - 729806355625

Fits standard round swivel studs only

Mounts directly into any BOG® with Switcheroo® platform



ENGINEERED FOR THE UNKNOWN®



**Smith & Wesson®**

**2023 RETURNING PRODUCTS**

✦ ACCESSORIES ✦



 **Smith & Wesson**  
**LIGHTS**

## NIGHT GUARD® DUAL BEAM HEADLAMP

SKU: 1117281 UPC: 661120081289

The Night Guard® Dual Beam Headlamp combines lightweight rugged performance with ultra-bright light output. 425 Lumen output and a secondary red LED make this light perfect for night time use.

### PRODUCT FEATURES

- 425 Lumens
- 2.2 Hr Runtime
- 36m Beam Distance
- Red & White LEDs
- USB Rechargeable
- Variable Dimming
- Removable Shirt/Hat Clip
- Light Rotates 120°
- Elastic Headband
- Blister Dims: 4.75" W X 7" H X 2" D
- Case Pack: 6
- Includes: Elastic Headband, USB Charging Cord

ANSI FL1 STANDARD  
**CERTIFIED**

 USB  
RECHARGEABLE  
LITHIUM



 **Smith & Wesson**

## NIGHT GUARD® QUAD BEAM HEADLAMP

SKU: 1117282 UPC: 661120081272

The Night Guard® Quad Beam Headlamp combines lightweight rugged performance, ultra-bright light output and multiple colors. 420 Lumen output with secondary red, blue and green LEDs gives you the freedom to use this headlamp in different situations.

### PRODUCT FEATURES

- 420 Lumens
- 2.1 Hr Runtime
- 36m Beam Distance
- Red, White, Green, And Blue LEDs
- USB Rechargeable
- Variable Dimming
- Removable Shirt/Hat Clip
- Light Rotates 120°
- Elastic Headband
- Blister Dims: 4.75" W X 7" H X 2" D
- Case Pack: 6
- Includes: Elastic Headband, USB Charging Cord

ANSI FL1 STANDARD  
**CERTIFIED**

 USB  
RECHARGEABLE  
LITHIUM



 **Smith & Wesson**

# NIGHT GUARD® MICRO FLASHLIGHT



SKU: 1117277 UPC: 661120081258

The Night Guard® Micro Flashlight packs a lot of light in a very little package. 120 Lumens output and an almost 3hr. runtime means this light will illuminate through any job.

## PRODUCT FEATURES

- 120 Lumens
- 2.75 Hr Runtime
- 50 Beam Distance
- Water Resistant
- High & Low modes
- Aerospace aluminum construction
- Tail cap switch with momentary ON
- Blister Dims: 5" W X 9" H X 1" D
- Case Pack: 6
- Includes: 1 AAA Battery

ANSI FL1 STANDARD  
CERTIFIED

WHITE HIGH OUTPUT LED



# NIGHT GUARD® SLIM FLASHLIGHT



SKU: 1117278 UPC: 661120081241

The Night Guard® Slim Flashlight is a very discreet "penlight" style flashlight. Perfect to slip into a breast pocket, this modern styled penlight has 165 Lumen of output and a 5.5hr runtime. The dual function pocket clip allows you to clip it to the brim of a hat or secure it to a pocket.

## PRODUCT FEATURES

- 165 Lumens
- 5.5 Hr Runtime
- 55m Beam Distance
- Water Resistant
- High & Low modes
- Aerospace aluminum construction
- Tail cap switch with momentary ON
- Blister Dims: 5" W X 9" H X 1" D
- Case Pack: 6
- Includes: 2 AAA Batteries

ANSI FL1 STANDARD  
CERTIFIED

WHITE HIGH OUTPUT LED



# NIGHT GUARD® ELITE FLASHLIGHT



SKU: 1117276 UPC: 661120081265

The Night Guard® Elite Flashlight is a perfect utility flashlight. Slim in design, this light packs a large 350 Lumen output. Great for use in a tool box, this light won't take up much space yet can still light up whatever you need. Made of Aerospace Aluminum this light is robust and will last you for years.

## PRODUCT FEATURES

- 350 Lumens
- 1.8 Hr Runtime
- 96m Beam Distance
- Water Resistant
- High output white LED
- High & Low modes
- Aerospace aluminum construction
- Tail cap switch with momentary ON
- Pocket clip
- Blister Dims: 5" W X 10.5" H X 1" D
- Case Pack: 6
- Includes: 2 AA Batteries

ANSI FL1 STANDARD  
CERTIFIED

WHITE HIGH OUTPUT LED



# NIGHT GUARD® DUAL BEAM FLASHLIGHT



SKU: 1117279 UPC: 661120081234

The Night Guard® Dual Beam Flashlight is a compact Powerhouse with 300 Lumens of bright white light in a flashlight under 5". Made of Aerospace Aluminum with a 1.5hr runtime. Light up the night or preserve your night vision with the red LED.

## PRODUCT FEATURES

- 300 Lumens
- 1.53 Hr Runtime
- 106m Beam Distance
- Water Resistant
- High output red & white LEDs
- High & Low modes
- Aerospace aluminum construction
- Dual function buttons
- Blister Dims: 5" W X 9" H X 2" D
- Case Pack: 6
- Includes: 3 AAA Batteries



# NIGHT GUARD® PRO FLASHLIGHT



SKU: 1098728 UPC: 661120417514

The S&W® Night Guard® Pro has an impact resistant, waterproof polymer body with an integral clip. It's waterproof to 1m submersion and has an insanely bright LED light producing 419 lumens. When the power goes out, trust Night Guard. Night Guard®: Your extreme defense tool in the dark with ultra-bright LED lighting built for everyday use.

## PRODUCT FEATURES

- 419 Lumens
- 1435 Cd
- 1 Meter Drop Resistant
- IPX7 Waterproof to 1M Deep
- 16.8 hr. Runtime (Depending On Mode)
- High, Medium, and Low Modes
- Beam Distance of 240 Meters
- Runs On AA Battery (Included)
- High Strength ABS Polymer Construction
- Digital ON/OFF Switch
- Memory Retention - Remembers Last Light Setting
- Clam Size: 6.25"W x 9.8"H x 1.8"D
- Case Pack: 6

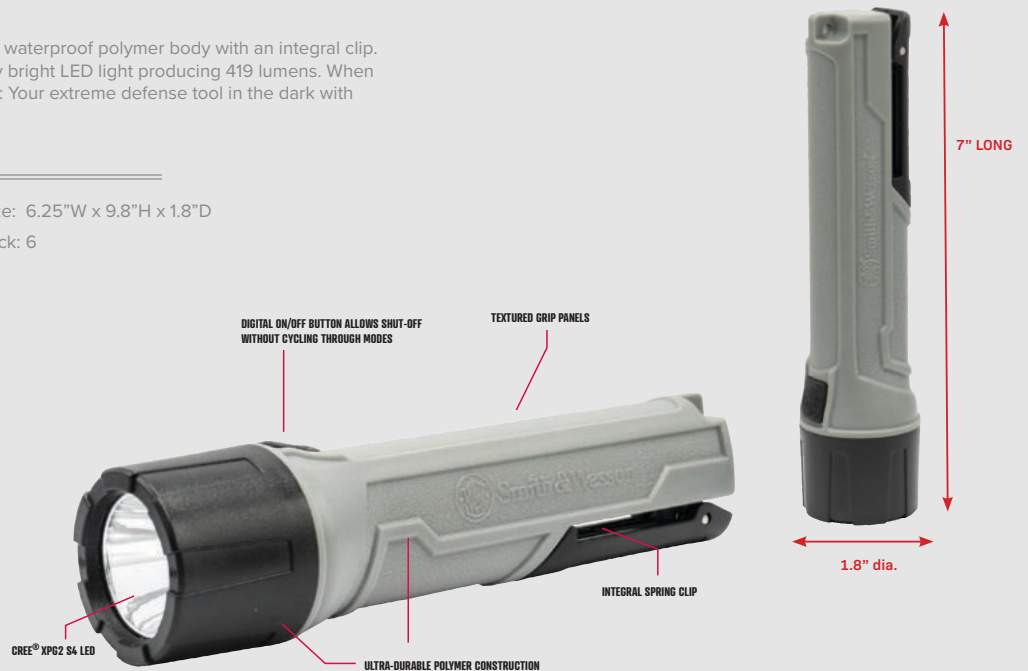
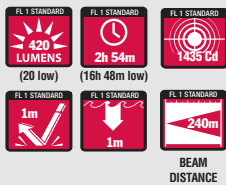

LOW-20L, MEDIUM-150L AND HIGH-420L MODES



# NIGHT GUARD® PRO COMPACT FLASHLIGHT



SKU: 1099890 UPC: 661120417545

The S&W® Night Guard® Pro Compact has an impact resistant, waterproof polymer body with an integral clip. It's waterproof to 1m submersion and has a seriously bright LED light producing 358 lumens. When the power goes out, trust Night Guard. Night Guard®: Your extreme defense tool in the dark with ultra-bright LED lighting built for everyday use.

## PRODUCT FEATURES

- 358 Lumens
- 770 Cd
- 1 Meter Drop Resistant
- IPX7 Waterproof to 1M Deep
- 8.5 hrs. Runtime (Depending On Mode)
- High, Medium, and Low Modes
- Beam Distance of 175 Meters
- Runs on (1) AAA Battery (Included)
- High Strength ABS Polymer Construction
- Clam Size: 5.5"W x 9"H x 1.5"D
- Case Pack: 6

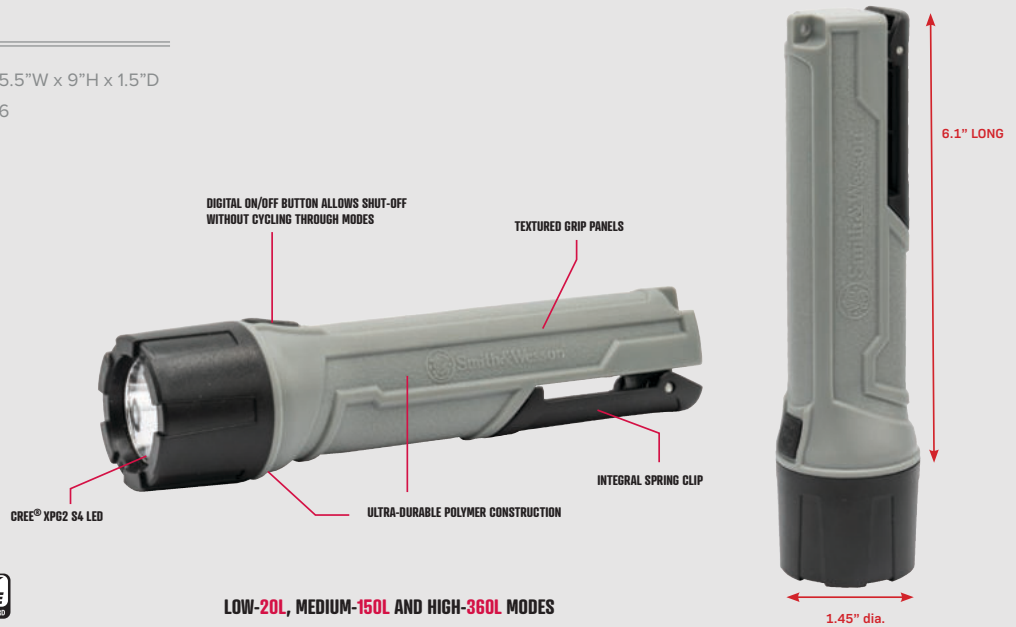
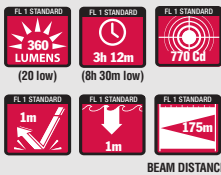

LOW-20L, MEDIUM-150L AND HIGH-360L MODES

# NIGHT GUARD® ELITE DUAL-BEAM FLASHLIGHT



SKU: 1097656 UPC: 661120417514

The S&W® Night Guard® Elite Dual-Beam is perfect for pilots with both white and red LEDs. The white light is great for inspections or area illumination and the red light is ideal for protecting night vision while reading maps or instruments. The independent switches allow control for both lights and Instant-Off digital switches with memory allows shutoff without cycling through modes. Night Guard®: Your extreme defense tool in the dark with ultra-bright LED lighting built for everyday use.

## PRODUCT FEATURES

- Perfect for aviators and pilots
- Runtime
  - White: 3hr 24m - High, 43hr - Low
  - Red: 7hr 24m high, 72hr 30m low
- 9360 Cd
- 1 Meter Drop Resistant
- IPX7 Waterproof to 1M Deep
- Memory Retention - Remembers Last Light Setting
- Includes 3 AAA batteries
- Anodized Aerospace Aluminum Construction
- 400 Lumens (White),
- 51 Lumens (Red)
- High and Low (Red and White) Modes
- Beam Distance Of 193 Meters
- Weight: 5.4 oz. (with batteries)
- Clam Size: 5"W x 8.4"H x 1.5"D
- Case Pack: 6

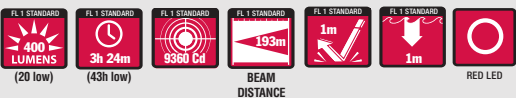

LOW-20L AND HIGH-400L MODES FOR WHITE  
LOW-2L AND HIGH-50L MODES FOR RED

# GALAXY® MICRO RAY



SKU: 1074564 UPC: 66120411291

Rely on our Smith & Wesson® Micro Ray flashlight to be the extra light you need. This flashlight is small, yet reliable, impact resistant, waterproof and BRIGHT. Clip this compact aluminum constructed flashlight on your keychain and never be without light again.

## PRODUCT FEATURES

- Batteries: 4-L736F batteries (INCLUDED)
- Length: 1.52"
- Constructed from anodized aerospace aluminum
- Head diameter: 0.44"
- Twist ON/OFF switch
- Weight: 0.25 oz (w. batteries)
- Impact resistant
- Case Pack: 6
- Waterproof
- Includes key chain split ring



# NIGHT GUARD® RXP HEADLAMP



SKU: 1098729 UPC: 66120417507

The S&W® Night Guard® RXP Headlamp is ultra-compact and super bright. It's made with impact resistant construction and is USB rechargeable with smart dimming, so you can get the perfect amount of light. It includes a removable 4-way clip for hats, straps, pockets, etc. Night Guard®: Your extreme defense tool in the dark with ultra-bright LED lighting built for everyday use.

## PRODUCT FEATURES

- High strength ABS Polymer construction
- USB rechargeable with included cord
- 3955 Cd
- 1 Meter Drop Resistant
- IPX7 Waterproof to 1M Deep
- Runtime: 1hr 43m - High, 15hr 36m - Low
- LG 9X LED
- Smooth variable dimming for the perfect amount of light
- Battery: 600mAh Internal rechargeable battery (included)
- 341 Lumens
- High, Low, Strobe and Momentary-ON Modes
- Beam Distance Of 162 Meters
- Clam Size: 4.73"W x 86.9"H x 2.4"D
- Product size: 1.6"H x 1.4"W
- Weight: 1.4 oz
- Case Pack: 6

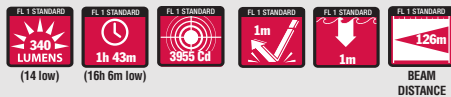
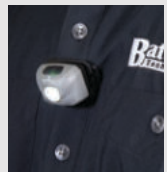

SMOOTH VARIABLE DIMMING: LOW-14L – HIGH-300L



# CORPORAL HALF FRAME SHOOTING GLASSES



- CORPORAL GLASSES BLUE/CLEAR LENS**  
BOX ITEM: 110164 UPC: 661120001799
- CORPORAL GLASSES RED/AMBER LENS**  
BOX ITEM: 110163 UPC: 661120001782
- CORPORAL GLASSES BLACK/SMOKE LENS**  
BOX ITEM: 110162 UPC: 661120001775

Protect your vision with our Corporal Half Frame Shooting Glasses. Its sleek design and sturdy frame give you ultimate protection, style, and comfort all in one. These glasses provide you with full peripheral eye coverage, so you are guaranteed all-around protection on the range or in the field. All Smith & Wesson® glasses include a microfiber bag for storage and scratch-free cleaning.

### PRODUCT FEATURES

- ANSI Z87+ certified
- Impact resistant
- UV400 rated
- MIL-PRF 32432 rated
- Full peripheral eye coverage
- Microfiber storage bag
- Non-slip rubber nose piece & ear stems
- Clam Size: 4"W x 9.25"H x 2.6"D
- Case Pack: 6

← 4" LONG →



# COLONEL SMALL FRAME SHOOTING GLASSES



BOX ITEM: 110272 UPC: 661120002062

Protect your vision with our Colonel Women's Half Frame Glasses. Its sleek design and sturdy frame provide ultimate protection, style and comfort all in one. These glasses provide you with full peripheral eye coverage, so you are guaranteed all-around protection on the range or in the field. It's a smaller frame made for women or youth shooters.

### PRODUCT FEATURES

- ANSI Z87+ certified
- Impact resistant
- UV400 rated
- MIL-PRF 32432 rated
- Full peripheral eye coverage
- Microfiber storage bag
- Non-slip rubber nose piece & ear stems
- Clam Size: 4"W x 9.25"H x 2.6"D
- Case Pack: 6



# MAJOR FULL FRAME SHOOTING GLASSES



- MAJOR GLASSES BLUE/SMOKE LENS**  
BOX ITEM: 110158 UPC: 661120001737
- MAJOR GLASSES BLUE/ CLEAR LENS**  
BOX ITEM: 110159 UPC: 661120001744
- MAJOR GLASSES BLUE/AMBER LENS**  
BOX ITEM: 110160 UPC: 661120001751

Protect your vision with our Major Full Frame Shooting Glasses. Its sleek design and sturdy frame give you ultimate protection, style and comfort all in one. These glasses provide you with full peripheral eye coverage, so you are guaranteed all-around protection on the range or in the field. All Smith & Wesson® glasses include a microfiber bag for storage and scratch-free cleaning.

## PRODUCT FEATURES

- ANSI Z87+ certified
- Impact resistant
- UV400 rated
- MIL-PRF 32432 rated
- Full peripheral eye coverage
- Microfiber storage bag
- Non-slip rubber nose piece & ear stems
- Clam Size: 4"W x 9.25"H x 2.6"D
- Case Pack: 6



# SERGEANT GLASSES BLACK/SMOKE LENS



BOX ITEM: 110165 UPC: 661120001805

Our Sergeant Full Frame Glasses will give you ultimate protection, style and comfort all in one. With its sleek design and sturdy frame, these glasses are hard to beat. They provide full peripheral eye coverage, so you are guaranteed all-around protection on the range or in the field. All Smith & Wesson® glasses include a microfiber bag for storage and scratch-free cleaning.

## PRODUCT FEATURES

- ANSI Z87+ certified
- Impact resistant
- UV400 rated
- MIL-PRF 32432 rated
- Full peripheral eye coverage
- Microfiber storage bag
- Non-slip rubber nose piece & ear stems
- Case Pack: 6





**Smith & Wesson®**  
**BAGS AND CASES**

## DEFENDER HANDGUN CASES

### DEFENDER HANDGUN CASE - SMALL

SKU: 110018 UPC: 661120000174

### DEFENDER HANDGUN CASE - MEDIUM

SKU: 110019 UPC: 661120000181

### DEFENDER HANDGUN CASE - LARGE

SKU: 110020 UPC: 661120000198

Keep your handguns protected with the Smith & Wesson® Defender Handgun Case. Its durable fabric and sturdy case is designed to uphold in any condition. This handgun case provides ultimate protection for your favorite pistols.

#### PRODUCT FEATURES

##### INSIDE:

- Perfect for transporting or storing individual handguns
- Padded walls for protection

##### OUTSIDE:

- Full-length zipper for easy access



#### Large

Size: 16"W x 9"H x 1.5"D

Case Pack: 6

#### Medium

Size: 13"W x 7"H x 1.5"D

Case Pack: 6

#### Small

Size: 9"W x 6"H x 1.5"D

Case Pack: 6

## RECRUIT TACTICAL RANGE BAG

SKU: 110013 UPC: 661120000174

Keep all your favorite gear organized and ready with the Recruit Tactical Range Bag. This heavy-duty carrying bag is designed with quality and durability in mind. It's built to hold up under the most extreme conditions, letting you have instant access to your stuff anywhere. The sturdy ballistic fabric, oversized zippers, and rubber foot skids on the bottom for extra protection will keep your gear protected.

#### PRODUCT FEATURES

##### INSIDE:

- 2 inside full-length accessory pockets
- Internal dimensions of main compartment: approx. 15" W x 8" H x 8" D

##### OUTSIDE:

- Adjustable 2" wide padded carrying strap with heavy-duty spring clip buckles
- Dual zippered opening gives ample room
- Reinforced wrap-around nylon carrying handles with rubber foot skids on the bottom
- External dimensions: 17" W x 10" H x 10" D

- Case Pack: 4





**M&P**<sup>®</sup>

by **Smith & Wesson**<sup>®</sup>

**2023 RETURNING PRODUCTS**

**ACCESSORIES**



## DUTY SERIES GUN CASE SMALL

### PRODUCT FEATURES

- MULTIPLE (3) AR MAG POUCHES
- MADE OF DURABLE BALLISTIC FABRIC
- FULL-LENGTH ZIPPER
- ADJUSTABLE NYLON SHOULDER STRAP
- HEAVY-DUTY CARRY HANDLES
- ZIPPERED EXTERNAL POCKET
- EXTERNAL CENTER OPEN POCKET
- OVERALL DIMS: 35.5" L X 12" H X 2" D



### PACKAGE

ITEM: 110014  
 UPC: 661120000112  
 CASE PACK: 6



## DUTY SERIES GUN CASE MEDIUM

### PRODUCT FEATURES

- MULTIPLE (4) AR MAG POUCHES
- MADE OF DURABLE BALLISTIC FABRIC
- FULL-LENGTH ZIPPER
- ADJUSTABLE NYLON SHOULDER STRAP
- HEAVY-DUTY CARRY HANDLES
- ZIPPERED EXTERNAL POCKET
- EXTERNAL CENTER OPEN POCKET
- OVERALL DIMS: 41.5" L X 12" H X 2" D



### PACKAGE

ITEM: 110015  
 UPC: 661120000136  
 CASE PACK: 6



## DUTY SERIES GUN CASE LARGE

### PRODUCT FEATURES

- MULTIPLE (5) AR MAG POUCHES
- MADE OF DURABLE BALLISTIC FABRIC
- FULL-LENGTH ZIPPER
- ADJUSTABLE NYLON SHOULDER STRAP
- HEAVY-DUTY CARRY HANDLES
- ZIPPERED EXTERNAL POCKET
- EXTERNAL CENTER OPEN POCKET
- OVERALL DIMS: 46.5" L X 12" H X 2" D



Gun Fit Length: 45 in

Overall Length: 46.5 in



#### PACKAGE

ITEM: 110016  
 UPC: 661120000143  
 CASE PACK: 6



## PRO TAC GUN CASE LARGE

### PRODUCT FEATURES

#### OUTSIDE:

- FULL-LENGTH 2" WIDE ADJUSTABLE, PADDED SHOULDER STRAP
- FULL-LENGTH DOUBLE ZIPPER OPENING
- 31" L X 13" H X 1.5" D FULL FLAP ZIPPERED EXTERNAL POUCH
- MADE OF DURABLE BALLISTIC FABRIC
- OVERALL DIMS: 42" L X 13" H X 3" D

#### INSIDE:

- 2 ROWS OF M.O.L.L.E. STRAPPING WITH 4 HOOK & LOOP INTERCHANGEABLE STRAPS
- FRONT, BACK AND BOTTOM PADDED WALLS FOR SEMI-RIGID PROTECTION



Gun Fit Length: 42 in

Overall Length: 42 in



#### PACKAGE

ITEM: 110025  
 UPC: 661120000242  
 CASE PACK: 4



## PRO TAC HANDGUN CASE SINGLE

### PRODUCT FEATURES

#### OUTSIDE:

- DOUBLE ZIPPER OPENING OF MAIN COMPARTMENT
- 2 EXTERNAL ZIPPERED POCKETS: 6" W X 6" H X 1" D
- 3 DOUBLE PISTOL MAG POUCHES WITH HOOK & LOOP FLAP CLOSURES
- FRONT, BACK AND BOTTOM PADDED WALLS FOR PROTECTION
- FULL WRAP AROUND HEAVY-DUTY NYLON CARRY STRAPS
- EXTERNAL DIMENSIONS: 14.5" W X 8" H X 3" D

#### INSIDE:

- 1 INTERNAL PADDED PISTOL POCKET
- FITS A REVOLVER WITH UP TO A 7" BARREL
- INTERNAL POCKET DIMENSIONS: 14" X 7"



Overall Length: 14.5 in

#### PACKAGE

ITEM: 110028  
 UPC: 661120000273  
 CASE PACK: 6





# PRO TAC HANDGUN CASE DOUBLE

## PRODUCT FEATURES

### OUTSIDE:

- DOUBLE ZIPPER OPENING OF MAIN COMPARTMENT
- 2 EXTERNAL ZIPPERED POCKETS: 6" W X 6" H X 1" D
- 3 DOUBLE PISTOL MAG POUCHES WITH HOOK & LOOP FLAP CLOSURES
- FRONT, BACK AND BOTTOM PADDED WALLS FOR PROTECTION
- FULL WRAP-AROUND HEAVY-DUTY NYLON CARRY STRAPS
- EXTERNAL DIMENSIONS: 15.5" W X 10.5" H X 4" D

### INSIDE:

- 2 INTERNAL PADDED PISTOL POCKETS
- EACH POCKET FITS A REVOLVER WITH UP TO AN 8" BARREL
- INTERNAL POCKET DIMENSIONS: 14" X 6"



### PACKAGE

ITEM: 110029  
 UPC: 661120000280  
 CASE PACK: 6



# PRO TAC 4 PISTOL MAGAZINE POUCH

## PRODUCT FEATURES

- 4 PISTOL MAGAZINE POUCHES
- WILL ACCEPT SINGLE OR DOUBLE STACK MAGAZINES
- MADE OF DURABLE BALLISTIC FABRIC
- 2 EXTRA WIDE FOLD-OVER FLAPS WITH HOOK & LOOP CLOSURES
- OUTSIDE OF 1 FLAP HAS LOOP BACKING TO ATTACH CUSTOM PATCHES
- DOUBLE STITCH REINFORCEMENT
- BACKSIDE HAS 3 M.O.L.L.E. SNAP ATTACHMENTS
- EXTERNAL DIMENSIONS: APPROX. 8.5" W X 5.25" H X 1.5" D



Holds 4 Pistol Magazines

### PACKAGE

ITEM: 110178  
 UPC: 661120001935  
 CASE PACK: 6



# PRO TAC AR/AK 6 MAGAZINE POUCH

## PRODUCT FEATURES

- 6 AR/AK MAGAZINE POUCHES
- WILL ACCEPT 1 AK OR 2 AR, 30RND MAGAZINES PER POUCH
- DOUBLE SIDED, 3 POUCHES PER SIDE
- MADE OF DURABLE BALLISTIC FABRIC
- 6 FOLD-OVER FLAPS WITH HOOK & LOOP CLOSURES
- OUTSIDE OF 1 FLAP HAS LOOP BACKING TO ATTACH CUSTOM PATCHES
- DOUBLE STITCH REINFORCEMENT
- ADJUSTABLE SHOULDER STRAP WITH HEAVY-DUTY HARDWARE
- EXTERNAL DIMENSIONS: APPROX. 11.125" W X 7.75" H X 6" D



Holds Up To 6 AK Magazines or 12 AR Magazines



### PACKAGE

ITEM: 110181  
 UPC: 661120001966  
 CASE PACK: 6



## OFFICER TACTICAL RANGE BAG

### PRODUCT FEATURES

#### OUTSIDE:

- ADJUSTABLE 2" WIDE PADDED CARRYING STRAP WITH HEAVY-DUTY SPRING CLIP BUCKLES
- DUAL ZIPPERED OPENING FOR ACCESS TO THE MAIN STORAGE AREA
- REINFORCED WRAP-AROUND NYLON CARRYING HANDLES WITH RUBBER FOOT SKIDS ON THE BOTTOM
- INTERNAL DIMENSIONS OF MAIN COMPARTMENT: APPROX. 18" W X 10" H X 10" D
- EXTERNAL DIMENSIONS: 22" W X 14" H X 10.5" D

#### INSIDE:

- 2 INSIDE FULL-LENGTH ACCESSORY POCKETS
- INCLUDES 2 PADDED, ZIPPERED SINGLE HANDGUN CASES: 13.5" X 9.5"
- INTERNAL PADDED AMMO BAG WITH 2 ZIPPERED SIDE POCKETS
- 2 ADJUSTABLE HOOK AND LOOP DIVIDING WALLS
- 2 SETS OF VERTICAL ACCESSORY POUCHES
- CLIP-ON NYLON BRASS HOLDER WITH CINCH DOWN CLOSURE



#### PACKAGE

ITEM: 110023  
UPC: 661120000228  
CASE PACK: 6



## DUTY SERIES BACKPACK SMALL

### PRODUCT FEATURES

#### OUTSIDE:

- MADE OF DURABLE BALLISTIC FABRIC
- FRONT ZIPPERED EXTERNAL POCKET
- LARGE FRONT POUCH: 8" W X 10" H X 2" D
- 2 SMALL ACCESSORY CLIPS
- EXTERNAL M.O.L.L.E. WEBBING
- EXTERNAL DIMENSIONS: 13" W X 18" H X 7" D

#### INSIDE:

- DUAL ZIPPER OPENING
- 11" X 12" ELASTIC LAPTOP POCKET
- 2 ZIPPERED MESH POCKETS
- ZIPPERED TOP POCKET
- INTERNAL DIMENSIONS: 12" W X 20" H X 5" D



#### PACKAGE

ITEM: 110017  
UPC: 661120000167  
CASE PACK: 6



KITS AND TOOLS



## COMPACT HANDGUN CLEANING KIT

### PRODUCT FEATURES

- FOR USE ON PISTOL CALIBERS RANGING FROM .22-.45 (.22, 9MM/.357/.38, .40/10MM, .44-.45 CALIBERS)
- COLLAPSIBLE CLEANING ROD WITH ROTATING T-HANDLE
- STAINLESS STEEL CLEANING ROD

#### KIT INCLUDES:

- CLEANING PICK
- NYLON CLEANING BRUSH
- PISTOL BRUSHES FOR .22-.45 CAL
- JAGS FOR .22-.45 CAL
- SLOTTED TIPS



#### PACKAGE

ITEM: 110176  
UPC: 661120001911  
CASE PACK: 6



## HANDGUN FIELD CLEANING KIT

### PRODUCT FEATURES

- DESIGNED FOR .380/9MM, .40, AND .45 CALIBERS
- LARGE COTTON SWAB FOR CLEANING BARRELS, CHAMBERS AND CYLINDERS
- NYLON BRUSH WITH PICK FOR STUBBORN FOULING
- LINT-FREE CLOTH FOR WIPING DOWN FIREARMS
- PRE-SATURATED OIL WIPES FOR METAL PROTECTION
- RESEALABLE PACKAGE
- DISPOSABLE GLOVES
- GREASE PACKET
- PACKAGE DIMS: 2.8"W X 7"H X .6"D



#### PACKAGE

ITEM: 1082193  
UPC: 661120412946  
CASE PACK: 10



## COMPACT RIFLE CLEANING KIT

### PRODUCT FEATURES

- SEMI-RIGID CARRY CASE FITS INTO AN AR MAGAZINE POUCH
- FOR USE ON .22 OR .30 CALIBER RIFLES

#### KIT INCLUDES:

- AR CHAMBER BRUSH
- MULTI-FUNCTION BOLT SCRAPER TOOL
- CLEANING PICK
- NYLON CLEANING BRUSH
- COLLAPSIBLE 36" STAINLESS STEEL CLEANING ROD WITH ROTATING T-HANDLE
- 3 STAR CHAMBER CLEANING PADS
- PATCHES FOR .22 OR .30 CAL
- NYLON BRUSHES FOR .22 OR .30 CAL
- JAGS FOR .22 OR .30 CAL
- SLOTTED TIP



#### PACKAGE

ITEM: 1084758  
UPC: 661120414247  
CASE PACK: 6



# SINGLE POINT TACTICAL SLING KIT

## PRODUCT FEATURES

### SLING

- PREMIUM SPRING-LOADED CARABINER
- FLEXIBLE HIGH-DENSITY BUNGEE STRAP WITH NYLON COVER
- QUICK-DITCH SIDE RELEASE BUCKLE
- FULLY ADJUSTABLE
- AMBIDEXTROUS FOR ALL SHOOTERS

### AR RECEIVER END PLATE

- AMBIDEXTROUS FOR ALL SHOOTERS
- ACCEPTS SNAP HOOK STYLE ATTACHMENTS
- ONE SOLID STEEL PLATE
- END PLATE MADE IN THE USA



### PACKAGE

ITEM: 110030  
 UPC: 661120000297  
 CASE PACK: 6



# AR-15 CUSTOMIZABLE LOWER PARTS

## PRODUCT FEATURES

### KIT INCLUDES:

- BOLT CATCH
- BOLT CATCH PLUNGER
- BOLT CATCH ROLL PIN
- BOLT CATCH SPRING
- BUFFER RETAINER
- BUFFER RETAINER SPRING
- HAMMER PIN
- MAGAZINE CATCH
- MAGAZINE CATCH BUTTON
- MAGAZINE CATCH SPRING
- PIVOT PIN
- PIVOT PIN DETENT
- PIVOT PIN DETENT SPRING
- SELECTOR
- SELECTOR DETENT
- SELECTOR DETENT SPRING
- TAKEDOWN PIN
- TAKEDOWN PIN DETENT
- TAKEDOWN PIN DETENT SPRING
- TRIGGER PIN



### PACKAGE

ITEM: 110115  
 UPC: 661120001270  
 CASE PACK: 6



# AR-15 COMPLETE LOWER PARTS KIT

## PRODUCT FEATURES

### KIT INCLUDES:

- BOLT CATCH
- BOLT CATCH PLUNGER
- BOLT CATCH ROLL PIN
- BOLT CATCH SPRING
- BUFFER RETAINER
- BUFFER RETAINER SPRING
- DISCONNECTOR
- DISCONNECTOR SPRING
- HAMMER
- HAMMER PIN
- HAMMER SPRING
- MAGAZINE CATCH
- MAGAZINE CATCH BUTTON
- MAGAZINE CATCH SPRING
- PISTOL GRIP
- PISTOL GRIP LOCK WASHER
- PISTOL GRIP SCREW
- PIVOT PIN
- PIVOT PIN DETENT
- PIVOT PIN DETENT SPRING
- SELECTOR
- SELECTOR DETENT
- SELECTOR DETENT SPRING
- TAKEDOWN PIN
- TAKEDOWN PIN DETENT
- TAKEDOWN PIN DETENT SPRING
- TRIGGER
- TRIGGER GUARD
- TRIGGER GUARD ROLL PIN
- TRIGGER PIN
- TRIGGER SPRING



### PACKAGE

ITEM: 1085634  
 UPC: 661120412649  
 CASE PACK: 6



## AR-15 COMPLETE UPPER PARTS KIT

### PRODUCT FEATURES

KIT INCLUDES:

- FORWARD ASSIST - ASSEMBLED
- FORWARD ASSIST SPRING
- FORWARD ASSIST ROLL PIN
- EJECTION PORT COVER
- EJECTION PORT SPRING
- EJECTION PORT PIN
- HINGE PIN CLIP



PACKAGE

ITEM: 110116  
 UPC: 661120001287  
 CASE PACK: 6



## AR ESSENTIAL PARTS KIT

### PRODUCT FEATURES

KIT INCLUDES:

- BOLT CATCH PLUNGER
- BOLT CATCH SPRING
- BOLT CATCH ROLL PIN
- BUFFER RETAINER
- BUFFER RETAINER SPRING
- DISCONNECTOR SPRING
- HAMMER SPRING
- TRIGGER SPRING
- HAMMER PIN
- TRIGGER PIN
- PIVOT PIN DETENT
- PIVOT PIN DETENT SPRING
- TAKEDOWN PIN DETENT
- TAKEDOWN PIN DETENT SPRING
- SELECTOR DETENT
- SELECTOR DETENT SPRING
- TRIGGER GUARD ROLL PIN
- MAGAZINE CATCH SPRING



PACKAGE

ITEM: 1078425  
 UPC: 661120412687  
 CASE PACK: 6



## M&P PISTOL NOVELTY MULTI-TOOL

### PRODUCT FEATURES

- STAINLESS STEEL CONSTRUCTION
- 13 DIFFERENT TOOLS IN A COMPACT DESIGN
- INCLUDES ALUMINUM CARABINER

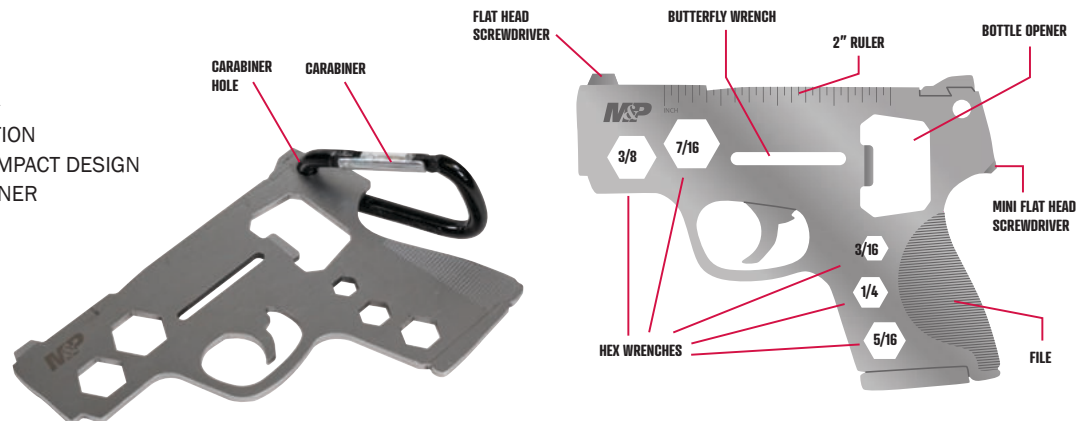

PACKAGE

ITEM: 1094693  
 UPC: 661120416081  
 CASE PACK: 6



EYE AND EAR PROTECTION



## THUNDERBOLT SHOOTING GLASSES

### PRODUCT FEATURES

- ANSI Z87+ CERTIFIED
- IMPACT RESISTANT
- UV400 RATED
- MIL-PRF 32432 RATED
- FULL PERIPHERAL EYE COVERAGE
- ANTI-FOG LENSES
- HARD ZIPPERED STORAGE CASE WITH MICROFIBER CLOTH
- NON-REFLECTIVE MATTE BLACK FRAMES



Available in black frames with the following lenses:



**SMOKE LENS**  
 ITEM: 110166  
 UPC: 661120001812  
 CASE PACK: 6

**AMBER LENS**  
 ITEM: 110167  
 UPC: 661120001829  
 CASE PACK: 6

**CLEAR MIRROR LENS**  
 ITEM: 110168  
 UPC: 661120001836  
 CASE PACK: 6



## SUPER COBRA SHOOTING GLASSES

### PRODUCT FEATURES

- ANSI Z87+ CERTIFIED
- IMPACT RESISTANT
- UV400 RATED
- MIL-PRF 32432 RATED
- FULL PERIPHERAL EYE COVERAGE
- ANTI-FOG LENSES
- HARD ZIPPERED STORAGE CASE WITH MICROFIBER CLOTH
- NON-REFLECTIVE MATTE BLACK FRAMES
- NON-SLIP RUBBER NOSE & EAR PIECES



Available in black frames with the following lenses:



**SMOKE LENS**  
 ITEM: 110169  
 UPC: 661120001843  
 CASE PACK: 6

**AMBER LENS**  
 ITEM: 110170  
 UPC: 661120001850  
 CASE PACK: 6

**CLEAR MIRROR LENS**  
 ITEM: 110171  
 UPC: 661120001867  
 CASE PACK: 6



# WHITEHAWK SHOOTING GLASSES

## PRODUCT FEATURES

- ANSI Z87+ CERTIFIED
- IMPACT RESISTANT
- UV400 RATED
- MIL-PRF 32432 RATED
- FULL PERIPHERAL EYE COVERAGE
- ANTI-FOG LENSES
- HARD ZIPPERED STORAGE CASE WITH MICROFIBER CLOTH
- NON-SLIP RUBBER NOSE & EAR PIECES



Available in black frames with the following lenses:



#110172



#110173



#110171



**SMOKE MIRROR LENS**

ITEM: 110172  
UPC: 661120001874  
CASE PACK: 6

**BLUE MIRROR LENS**

ITEM: 110173  
UPC: 661120001881  
CASE PACK: 6

**CLEAR MIRROR LENS**

ITEM: 110174  
UPC: 661120001898  
CASE PACK: 6



# HARRIER INTERCHANGEABLE SHOOTING GLASSES

## PRODUCT FEATURES

- ANSI Z87+ CERTIFIED
- IMPACT RESISTANT
- UV400 RATED
- FULL PERIPHERAL EYE COVERAGE
- ANTI-FOG LENSES
- 4 SETS OF INTERCHANGEABLE LENSES
- "ONE-TOUCH" LENS SWAPS (NO FLEXING OR BENDING FRAMES TO REMOVE LENSES)
- HARD ZIPPERED STORAGE CASE WITH 3 MICROFIBER LENS BAGS
- NON-SLIP RUBBER NOSE & EAR PIECES



**PACKAGE**

ITEM: 110175  
UPC: 661120001904  
CASE PACK: 6



# ALPHA ELECTRONIC EAR MUFF

## PRODUCT FEATURES

- 23 NRR NOISE REDUCTION
- FOLDING COMPACT DESIGN
- PADDED HEADBAND
- LED ON INDICATOR LIGHT
- AUDIO INPUT JACK TO CONNECT PHONE OR MUSIC PLAYER
- ADJUSTABLE CUSHIONED EAR CUPS
- ANSI S3.19-1974 RATED
- AMPLIFIES LOW LEVEL SOUNDS
- COMPRESSES HIGH DB NOISES
- USES 2 AAA BATTERIES (INCLUDED)



**PACKAGE**

ITEM: 110041  
UPC: 661120000488  
CASE PACK: 6



FLASHLIGHTS



## DELTA FORCE® CS-10 FLASHLIGHT

### PRODUCT FEATURES

- CREE® XBH LED
- LENGTH: 4"
- HEAD DIAMETER: 0.81"
- WEIGHT: 2.05 OZ (W. BATTERIES)
- BATTERIES: 1 - AA BATTERY (INCLUDED)
- HIGH, LOW, STROBE AND MOMENTARY-ON FUNCTIONS
- MEMORY RETENTION REMEMBERS LAST LIGHT SETTING
- CONSTRUCTED FROM ANODIZED AEROSPACE ALUMINUM
- ON/OFF TAIL CAP SWITCH
- DUAL-FUNCTION SPRING STEEL CLIP ATTACHES TO POCKET, BELT OR HAT BILL CRENULATED HEAD FOR SELF DEFENSE



|   |   |
|---|---|
| FL 1 STANDARD<br>130 LUMENS<br>(20 low) | FL 1 STANDARD<br>4h 15m<br>(9h 30m low) |
| FL 1 STANDARD<br>101m<br>(36m low)      | FL 1 STANDARD<br>2660 CA                |
| FL 1 STANDARD<br>1m                     | FL 1 STANDARD<br>1m                     |
| STROBE                                  | WM<br>WEAPON MOUNTABLE                  |

### PACKAGE

ITEM: 110146  
UPC: 661120001614  
CASE PACK: 6



## DELTA FORCE® CS-20 FLASHLIGHT

### PRODUCT FEATURES

- CREE® XPG2 LED
- LENGTH: 3.5"
- HEAD DIAMETER: 0.81"
- WEIGHT: 2.54 OZ (W. BATTERY)
- BATTERIES: 1 - CR123 BATTERY (INCLUDED)
- HIGH, LOW, STROBE AND MOMENTARY-ON FUNCTIONS
- MEMORY RETENTION REMEMBERS LAST LIGHT SETTING
- CONSTRUCTED FROM ANODIZED AEROSPACE ALUMINUM
- ON/OFF TAIL CAP SWITCH
- DUAL-FUNCTION SPRING STEEL CLIP ATTACHES TO POCKET, BELT OR HAT BILL CRENULATED HEAD FOR SELF DEFENSE



|   |   |
|---|---|
| FL 1 STANDARD<br>215 LUMENS<br>(25 low) | FL 1 STANDARD<br>2h 25m<br>(7h 15m low) |
| FL 1 STANDARD<br>120m<br>(36m low)      | FL 1 STANDARD<br>3507 CA                |
| FL 1 STANDARD<br>1m                     | FL 1 STANDARD<br>1m                     |
| STROBE                                  | WM<br>WEAPON MOUNTABLE                  |

### PACKAGE

ITEM: 110147  
UPC: 661120001621  
CASE PACK: 6





# DELTA FORCE® HL-10 HEADLAMP

## PRODUCT FEATURES

- CREE® XP-G2 R5 LED
- WEIGHT: 3.11 OZ (W. BATTERIES)
- BATTERIES: 3-AAA BATTERIES (INCLUDED)
- LIGHTWEIGHT, COMFORTABLE DESIGN
- LOW, MEDIUM, HIGH, TURBO-HIGH, STROBE AND S.O.S. MODES
- CONSTRUCTED FROM ANODIZED AEROSPACE ALUMINUM
- ONE-BUTTON CONTROL SWITCH FOR ONE-HANDED USE
- FULLY ADJUSTABLE HEADBAND



## PACKAGE

ITEM: 110152  
UPC: 661120001676  
CASE PACK: 6



# DUTY SERIES MS RXP 1X18650

## PRODUCT FEATURES

- CREE® XPL LED
- LENGTH: 6"
- HEAD DIAMETER: 1.81"
- WEIGHT: 8.25 OZ (W. BATTERY)
- BATTERIES: 1 - 18650 RECHARGEABLE BATTERY (INCLUDED)
- INTERNAL 3400MAH BATTERY BANK CAN CHARGE CELL PHONES, LIGHTS OR OTHER ACCESSORIES
- LOW, MEDIUM, HIGH, TURBO AND S.O.S. FUNCTIONS



- MEMORY RETENTION REMEMBERS LAST LIGHT SETTING
- CONSTRUCTED FROM ANODIZED AEROSPACE ALUMINUM
- DIGITAL ON/OFF SWITCH WITH LOCKOUT FEATURE
- CRENULEATED HEAD FOR SELF DEFENSE
- INCLUDES USB TO MICRO USB CHARGING CORD

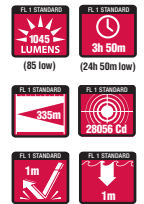

## PACKAGE

ITEM: 1074566  
UPC: 661120411079  
CASE PACK: 6



# DUTY SERIES CS RXP 1X18650 FLASHLIGHT

## PRODUCT FEATURES

- CREE® XPL LED
- LENGTH: 4.65"
- HEAD DIAMETER: 1.25"
- WEIGHT: 3.32 OZ (W. BATTERIES)
- BATTERIES: 1- 18650 RECHARGEABLE BATTERY (INCLUDED)
- LOW, MEDIUM, HIGH, TURBO AND S.O.S. FUNCTIONS
- MEMORY RETENTION REMEMBERS LAST LIGHT SETTING



- CONSTRUCTED FROM ANODIZED AEROSPACE ALUMINUM
- DIGITAL ON/OFF SWITCH WITH LOCKOUT FEATURE
- DUAL-FUNCTION SPRING STEEL CLIP
- CRENULEATED HEAD FOR SELF DEFENSE
- INCLUDES USB TO MICRO USB CHARGING CORD

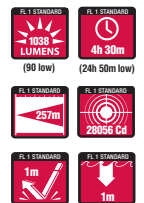

## PACKAGE

ITEM: 1078451  
UPC: 661120412144  
CASE PACK: 6



## DELTA FORCE® CS 1XAAA FLASHLIGHT

### PRODUCT FEATURES

- CREE® XPG2 LED
- LENGTH: 4.0"
- HEAD DIAMETER: 0.70"
- WEIGHT: 1.41 OZ (W. BATTERY)
- BATTERIES: 1-AAA BATTERIES (INCLUDED)
- HIGH, LOW, STROBE AND MOMENTARY-ON FUNCTIONS
- MEMORY RETENTION REMEMBERS LAST LIGHT SETTING
- CONSTRUCTED FROM ANODIZED AEROSPACE ALUMINUM
- TAIL CAP ON/OFF SWITCH
- DUAL-FUNCTION SPRING STEEL CLIP
- CRENUATED HEAD FOR SELF DEFENSE

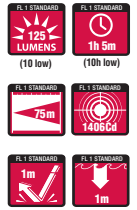

### PACKAGE

ITEM: 1078454  
UPC: 661120412168  
CASE PACK: 6



## DELTA FORCE® CS 2XAAA FLASHLIGHT

### PRODUCT FEATURES

- CREE® XPG2 LED
- LENGTH: 5.83"
- HEAD DIAMETER: 0.70"
- WEIGHT: 2.12 OZ (W. BATTERIES)
- BATTERIES: 2-AAA BATTERIES (INCLUDED)
- HIGH, LOW, STROBE AND MOMENTARY-ON FUNCTION
- MEMORY RETENTION REMEMBERS LAST LIGHT SETTING
- CONSTRUCTED FROM ANODIZED AEROSPACE ALUMINUM
- TAIL CAP ON/OFF SWITCH
- SPRING STEEL CLIP
- CRENUATED HEAD FOR SELF DEFENSE

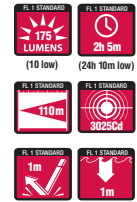

### PACKAGE

ITEM: 1078455  
UPC: 661120412571  
CASE PACK: 6



## DELTA FORCE® MS 2XAA FLASHLIGHT

### PRODUCT FEATURES

- CREE® XPG2 LED
- LENGTH: 6.34"
- HEAD DIAMETER: 1.1"
- WEIGHT: 5.78 OZ (W. BATTERIES)
- BATTERIES: 2- AA BATTERIES (INCLUDED)
- HIGH, LOW, STROBE AND MOMENTARY-ON FUNCTIONS
- MEMORY RETENTION REMEMBERS LAST LIGHT SETTING
- CONSTRUCTED FROM ANODIZED AEROSPACE ALUMINUM
- TAIL CAP ON/OFF SWITCH
- CRENUATED HEAD FOR SELF DEFENSE

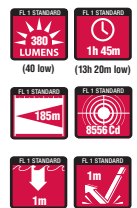

### PACKAGE

ITEM: 1078456  
UPC: 661120412588  
CASE PACK: 6



# DELTA FORCE® MS 2XCR123 FLASHLIGHT

## PRODUCT FEATURES

- CREE® XPL LED
- LENGTH: 5.4"
- HEAD DIAMETER: 1.4"
- WEIGHT: 5.86 OZ (W. BATTERIES)
- BATTERIES: 2- CR123 BATTERIES (INCLUDED)
- HIGH, LOW, STROBE AND MOMENTARY-ON FUNCTIONS
- MEMORY RETENTION REMEMBERS LAST LIGHT SETTING
- CONSTRUCTED FROM ANODIZED AEROSPACE ALUMINUM
- TAIL CAP ON/OFF SWITCH
- CRENULATED HEAD FOR SELF DEFENSE
- WEAPON-MOUNTABLE USING 1" RING



### PACKAGE

ITEM: 1078457  
 UPC: 661120412595  
 CASE PACK: 6



# DELTA FORCE® CS 2XCR123 FLASHLIGHT

## PRODUCT FEATURES

- CREE® XPG2 LED
- LENGTH: 4.8"
- HEAD DIAMETER: 0.95"
- WEIGHT: 2.82 OZ (W. BATTERIES)
- BATTERIES: 2- CR123 BATTERIES (INCLUDED)
- HIGH, LOW, STROBE AND MOMENTARY-ON FUNCTIONS
- MEMORY RETENTION REMEMBERS LAST LIGHT SETTING
- CONSTRUCTED FROM ANODIZED AEROSPACE ALUMINUM
- TAIL CAP ON/OFF SWITCH
- SPRING STEEL CLIP
- CRENULATED HEAD FOR SELF DEFENSE

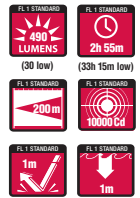

### PACKAGE

ITEM: 1078458  
 UPC: 661120412601  
 CASE PACK: 6



# DUTY SERIES MS RXP 1X18650 BATTERY BANK

## PRODUCT FEATURES

- CREE® XPL LED
- LENGTH: 5.9"
- HEAD DIAMETER: 1.57"
- WEIGHT: 7.41 OZ (W. BATTERY)
- BATTERIES: 1- 18650 RECHARGEABLE BATTERY (INCLUDED)
- LOW, HIGH, STROBE AND MOMENTARY-ON FUNCTIONS
- MEMORY RETENTION REMEMBERS LAST LIGHT SETTING
- CONSTRUCTED FROM ANODIZED AEROSPACE ALUMINUM
- TAIL CAP ON/OFF SWITCH
- CRENULATED HEAD FOR SELF DEFENSE
- LANYARD CARRY STRAP (INCLUDED)
- INCLUDES USB TO MICRO USB CHARGING CORD

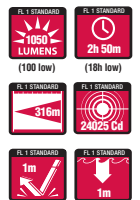

### PACKAGE

ITEM: 1081076  
 UPC: 661120412618  
 CASE PACK: 6



## PRODUCT FEATURES

- CREE® XHP 70.2 LED
- LENGTH: 9.65"
- HEAD DIAMETER: 2.2"
- WEIGHT: 17.64 OZ (W. BATTERIES)
- BATTERIES: 2 - 18650 RECHARGEABLE BATTERIES (INCLUDED)
- TRIPOD MOUNTABLE
- LOW, MEDIUM, HIGH, TURBO-HIGH, STROBE AND SOS FUNCTIONS
- CONSTRUCTED FROM ANODIZED AEROSPACE ALUMINUM



- DIGITAL ON/OFF SWITCH WITH LOCK OUT FEATURE
- CRENLATED HEAD FOR SELF DEFENSE
- RUBBER TEXTURED GRIP
- INCLUDES USB TO MICRO USB CHARGING CORD

## NIGHT TERROR® SLIM FLASHLIGHT

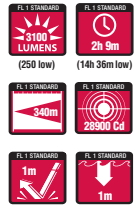

### PACKAGE

ITEM: 1081077  
UPC: 661120412625  
CASE PACK: 6



## PRODUCT FEATURES

- CREE® XHP 70.2 LED
- LENGTH: 6.2"
- HEAD DIAMETER: 1.76"
- WEIGHT: 7.83 OZ (W. BATTERIES)
- BATTERIES: 1 - INR 18650 RECHARGEABLE (INCLUDED)
- LOW, MEDIUM, HIGH, TURBO-HIGH, STROBE AND SOS FUNCTIONS
- MEMORY RETENTION REMEMBERS LAST LIGHT SETTING



- ANODIZED AEROSPACE ALUMINUM CONSTRUCTION
- DIGITAL ON/OFF SWITCH WITH LOCKOUT FEATURE
- CRENLATED HEAD FOR SELF DEFENSE
- RUBBER TEXTURED GRIP
- INCLUDES USB TO MICRO USB CHARGING CORD

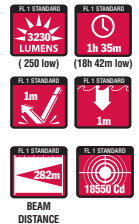

### PACKAGE

ITEM: 1097919  
UPC: 661120417477  
CASE PACK: 6



## PRODUCT FEATURES

- CREE® XPL HD V5 LED
- LENGTH: 5.6"
- HEAD DIA: 1.3"
- WEIGHT: 5.6 OZ (W. BATTERIES)
- BATTERIES: 1 - 18650 RECHARGEABLE BATTERY (INCLUDED)
- ADJUSTABLE HOLSTER WITH RETENTION (INCLUDED)
- 2 USB CHARGING STATIONS (INCLUDED)
- ANODIZED AEROSPACE ALUMINUM CONSTRUCTION
- CHARGES AUTOMATICALLY WHEN PLACED INTO CHARGING STATION
- CRENLATED HEAD FOR SELF DEFENSE



MECHANICAL RECESSED TAILCAP SWITCH WITH MOMENTARY ON FEATURE

TYPE III HARDCOAT ANODIZED ALUMINUM CONSTRUCTION



CREE® XPL HD V5 LED

QUICKLY AND EASILY RECHARGE FROM THE CHARGING STATION

INCLUDES ADJUSTABLE HOLSTER WITH RETENTION

2 USB CHARGING STATIONS INCLUDED

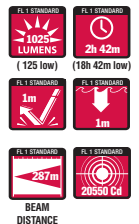

### PACKAGE

ITEM: 1098726  
UPC: 661120417484  
CASE PACK: 6



# OFFICER® ADJUSTABLE FLASHLIGHT HOLSTER

## PRODUCT FEATURES

- ULTRA DURABLE GLASS-FILLED NYLON CONSTRUCTION
- RETENTION ARMS FIRMLY HOLD FLASHLIGHT IN ANY POSITION, EVEN WHILE RUNNING
- FLASHLIGHT IS QUICKLY REMOVABLE WHEN NEEDED
- 360° ROTATION WITH 26 DETENT POSITIONS
- QUICK-RELEASE BELT CLIP FITS BELTS UP TO 2.25" W
- PERFECTLY DESIGNED FOR M&P® OFFICER FLASHLIGHT AND OTHER M&P® DELTA FORCE® MS LIGHTS
- FITS STREAMLIGHT® STRION® AND OTHER LIGHTS WITH 26-35MM BEZELS
- OPEN BOTTOM ALLOWS LIGHT TO BE USED WHILE STILL IN HOLSTER

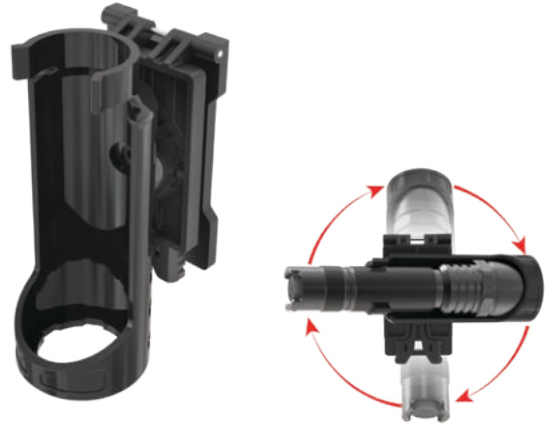

### PACKAGE

ITEM: 1098727  
 UPC: 661120417064  
 CASE PACK: 6



## PRODUCT FEATURES

- HIGH OUTPUT LED
- LENGTH: 4"
- DEPTH: 1.75"
- BATTERIES: 1 - 18650 RECHARGEABLE BATTERY (INCLUDED)
- LOW, MEDIUM, HIGH, TURBO HIGH, S.O.S., STROBE FUNCTIONS
- CONSTRUCTED FROM ANODIZED AEROSPACE ALUMINUM
- ILLUMINATED POWER INDICATOR
- 180° LIGHT ROTATION ON HEADBAND
- INCLUDES USB TO MICRO USB CHARGING CORD

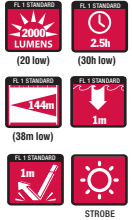

### PACKAGE

ITEM: 1117195  
 UPC: 661120080732  
 CASE PACK: 4





# NOTES

---

---

---

---

---

---

---

---

---

---

---

---

---

---

---

---

---

---

---

---

---

---

---

---

---

---



# AMERICAN OUTDOOR BRANDS™

1800 N RT. Z, SUITE A, COLUMBIA MO. 65202

[www.aob.com](http://www.aob.com)