

The logo features the letters 'M&P' in a bold, white, sans-serif font. The ampersand is stylized, connecting the 'M' and 'P'. A registered trademark symbol (®) is located at the bottom right of the 'P'.

by Smith & Wesson®

2024 PRODUCT CATALOG

ACCESSORIES



The logo features the letters 'M&P' in a bold, white, sans-serif font. The ampersand is stylized, with a small registered trademark symbol (®) to its upper right.

by **Smith & Wesson**®

2024 RETURNING PRODUCTS

ACCESSORIES



BAGS AND GASES



DUTY SERIES GUN CASE SMALL

PRODUCT FEATURES

- MULTIPLE (3) AR MAG POUCHES
- MADE OF DURABLE BALLISTIC FABRIC
- FULL-LENGTH ZIPPER
- ADJUSTABLE NYLON SHOULDER STRAP
- HEAVY-DUTY CARRY HANDLES
- ZIPPERED EXTERNAL POCKET
- EXTERNAL CENTER OPEN POCKET
- OVERALL DIMS: 35.5" L X 12" H X 2" D



Gun Fit Length: 34 in

Overall Length: 35.5 in

PACKAGE

ITEM: 110014
UPC: 661120000112

CASE PACK: 6





DUTY SERIES GUN CASE MEDIUM

PRODUCT FEATURES

- MULTIPLE (4) AR MAG POUCHES
- MADE OF DURABLE BALLISTIC FABRIC
- FULL-LENGTH ZIPPER
- ADJUSTABLE NYLON SHOULDER STRAP
- HEAVY-DUTY CARRY HANDLES
- ZIPPERED EXTERNAL POCKET
- EXTERNAL CENTER OPEN POCKET
- OVERALL DIMS: 41.5" L X 12" H X 2" D



Gun Fit Length: 40 in

Overall Length: 41.5 in

PACKAGE

ITEM: 110015
UPC: 661120000136

CASE PACK: 6





DUTY SERIES GUN CASE LARGE

PRODUCT FEATURES

- MULTIPLE (5) AR MAG POUCHES
- MADE OF DURABLE BALLISTIC FABRIC
- FULL-LENGTH ZIPPER
- ADJUSTABLE NYLON SHOULDER STRAP
- HEAVY-DUTY CARRY HANDLES
- ZIPPERED EXTERNAL POCKET
- EXTERNAL CENTER OPEN POCKET
- OVERALL DIMS: 46.5" L X 12" H X 2" D



Gun Fit Length: 45 in

Overall Length: 46.5 in

PACKAGE

ITEM: 110016
UPC: 661120000143

CASE PACK: 6





PRO TAC GUN CASE LARGE

PRODUCT FEATURES

OUTSIDE:

- FULL-LENGTH 2" WIDE ADJUSTABLE, PADDED SHOULDER STRAP
- FULL-LENGTH DOUBLE ZIPPER OPENING
- 31" L X 13" H X 1.5" D FULL FLAP ZIPPERED EXTERNAL POUCH
- MADE OF DURABLE BALLISTIC FABRIC
- OVERALL DIMS: 42" L X 13" H X 3" D

INSIDE:

- 2 ROWS OF M.O.L.L.E. STRAPPING WITH 4 HOOK & LOOP INTERCHANGEABLE STRAPS
- FRONT, BACK AND BOTTOM PADDED WALLS FOR SEMI-RIGID PROTECTION



Gun Fit Length: 42 in

Overall Length: 42 in



PACKAGE

ITEM: 110025
UPC: 661120000242

CASE PACK: 4



PRO TAC HANDGUN CASE SINGLE

PRODUCT FEATURES

OUTSIDE:

- DOUBLE ZIPPER OPENING OF MAIN COMPARTMENT
- 2 EXTERNAL ZIPPERED POCKETS: 6" W X 6" H X 1" D
- 3 DOUBLE PISTOL MAG POUCHES WITH HOOK & LOOP FLAP CLOSURES
- FRONT, BACK AND BOTTOM PADDED WALLS FOR PROTECTION
- FULL WRAP AROUND HEAVY-DUTY NYLON CARRY STRAPS
- EXTERNAL DIMENSIONS: 14.5" W X 8" H X 3" D

INSIDE:

- 1 INTERNAL PADDED PISTOL POCKET
- FITS A REVOLVER WITH UP TO A 7" BARREL
- INTERNAL POCKET DIMENSIONS: 14" X 7"



Overall Length: 14.5 in



PACKAGE

ITEM: 110028
UPC: 661120000273

CASE PACK: 6



PRO TAC HANDGUN CASE DOUBLE

PRODUCT FEATURES

OUTSIDE:

- DOUBLE ZIPPER OPENING OF MAIN COMPARTMENT
- 2 EXTERNAL ZIPPERED POCKETS: 6" W X 6" H X 1" D
- 3 DOUBLE PISTOL MAG POUCHES WITH HOOK & LOOP FLAP CLOSURES
- FRONT, BACK AND BOTTOM PADDED WALLS FOR PROTECTION
- FULL WRAP-AROUND HEAVY-DUTY NYLON CARRY STRAPS
- EXTERNAL DIMENSIONS: 15.5" W X 10.5" H X 4" D

INSIDE:

- 2 INTERNAL PADDED PISTOL POCKETS
- EACH POCKET FITS A REVOLVER WITH UP TO AN 8" BARREL
- INTERNAL POCKET DIMENSIONS: 14" X 6"



Overall Length: 15.5 in



PACKAGE

ITEM: 110029
UPC: 661120000280
CASE PACK: 6



PRO TAC 4 PISTOL MAGAZINE POUCH

PRODUCT FEATURES

- 4 PISTOL MAGAZINE POUCHES
- WILL ACCEPT SINGLE OR DOUBLE STACK MAGAZINES
- MADE OF DURABLE BALLISTIC FABRIC
- 2 EXTRA WIDE FOLD-OVER FLAPS WITH HOOK & LOOP CLOSURES
- OUTSIDE OF 1 FLAP HAS LOOP BACKING TO ATTACH CUSTOM PATCHES
- DOUBLE STITCH REINFORCEMENT
- BACKSIDE HAS 3 M.O.L.L.E. SNAP ATTACHMENTS
- EXTERNAL DIMENSIONS: APPROX. 8.5" W X 5.25" H X 1.5" D



Holds 4 Pistol Magazines



PACKAGE

ITEM: 110178
UPC: 661120001935

CASE PACK: 6



PRO TAC AR/AK 6 MAGAZINE POUCH

PRODUCT FEATURES

- 6 AR/AK MAGAZINE POUCHES
- WILL ACCEPT 1 AK OR 2 AR, 30RND MAGAZINES PER POUCH
- DOUBLE SIDED, 3 POUCHES PER SIDE
- MADE OF DURABLE BALLISTIC FABRIC
- 6 FOLD-OVER FLAPS WITH HOOK & LOOP CLOSURES
- OUTSIDE OF 1 FLAP HAS LOOP BACKING TO ATTACH CUSTOM PATCHES
- DOUBLE STITCH REINFORCEMENT
- ADJUSTABLE SHOULDER STRAP WITH HEAVY-DUTY HARDWARE
- EXTERNAL DIMENSIONS: APPROX. 11.125" W X 7.75" H X 6" D



Holds Up To 6 AK Magazines
or 12 AR Magazines



PACKAGE

ITEM: 110181
UPC: 661120001966

CASE PACK: 6



OFFICER TACTICAL RANGE BAG

PRODUCT FEATURES

OUTSIDE:

- ADJUSTABLE 2" WIDE PADDED CARRYING STRAP WITH HEAVY-DUTY SPRING CLIP BUCKLES
- DUAL ZIPPERED OPENING FOR ACCESS TO THE MAIN STORAGE AREA
- REINFORCED WRAP-AROUND NYLON CARRYING HANDLES WITH RUBBER FOOT SKIDS ON THE BOTTOM
- INTERNAL DIMENSIONS OF MAIN COMPARTMENT: APPROX. 18" W X 10" H X 10" D
- EXTERNAL DIMENSIONS: 22" W X 14" H X 10.5" D

INSIDE:

- 2 INSIDE FULL-LENGTH ACCESSORY POCKETS
- INCLUDES 2 PADDED, ZIPPERED SINGLE HANDGUN CASES: 13.5" X 9.5"
- INTERNAL PADDED AMMO BAG WITH 2 ZIPPERED SIDE POCKETS
 - 2 ADJUSTABLE HOOK AND LOOP DIVIDING WALLS
 - 2 SETS OF VERTICAL ACCESSORY POUCHES
- CLIP-ON NYLON BRASS HOLDER WITH CINCH DOWN CLOSURE



PACKAGE

ITEM: 110023
UPC: 661120000228
CASE PACK: 6





DUTY SERIES BACKPACK SMALL

PRODUCT FEATURES

OUTSIDE:

- MADE OF DURABLE BALLISTIC FABRIC
- FRONT ZIPPERED EXTERNAL POCKET
- LARGE FRONT POUCH: 8" W X 10" H X 2" D
- 2 SMALL ACCESSORY CLIPS
- EXTERNAL M.O.L.L.E. WEBBING
- EXTERNAL DIMENSIONS: 13" W X 18" H X 7" D

INSIDE:

- DUAL ZIPPER OPENING
- 11" X 12" ELASTIC LAPTOP POCKET
- 2 ZIPPERED MESH POCKETS
- ZIPPERED TOP POCKET
- INTERNAL DIMENSIONS: 12" W X 20" H X 5" D



PACKAGE

ITEM: 110017

UPC: 661120000167

CASE PACK: 6



KITTS AND TOOLS



COMPACT HANDGUN CLEANING KIT

PRODUCT FEATURES

- FOR USE ON PISTOL CALIBERS RANGING FROM .22-.45 (.22, 9MM/.357/.38, .40/10MM, .44-.45 CALIBERS)
- COLLAPSIBLE CLEANING ROD WITH ROTATING T-HANDLE
- STAINLESS STEEL CLEANING ROD

KIT INCLUDES:

- CLEANING PICK
- NYLON CLEANING BRUSH
- PISTOL BRUSHES FOR .22-.45 CAL
- JAGS FOR .22-.45 CAL
- SLOTTED TIPS



PACKAGE

ITEM: 110176
UPC: 661120001911

CASE PACK: 6

HANDGUN FIELD CLEANING KIT

PRODUCT FEATURES

- DESIGNED FOR .380/9MM, .40, AND .45 CALIBERS
- LARGE COTTON SWAB FOR CLEANING BARRELS, CHAMBERS AND CYLINDERS
- NYLON BRUSH WITH PICK FOR STUBBORN FOULING
- LINT-FREE CLOTH FOR WIPING DOWN FIREARMS
- PRE-SATURATED OIL WIPES FOR METAL PROTECTION
- RESEALABLE PACKAGE
- DISPOSABLE GLOVES
- GREASE PACKET
- PACKAGE DIMS: 2.8"W X 7"H X .6"D



PACKAGE

ITEM: 1082193
UPC: 661120412946
CASE PACK: 10



COMPACT RIFLE CLEANING KIT

PRODUCT FEATURES

- SEMI-RIGID CARRY CASE FITS INTO AN AR MAGAZINE POUCH
- FOR USE ON .22 OR .30 CALIBER RIFLES

KIT INCLUDES:

- AR CHAMBER BRUSH
- MULTI-FUNCTION BOLT SCRAPER TOOL
- CLEANING PICK
- NYLON CLEANING BRUSH
- COLLAPSIBLE 36" STAINLESS STEEL CLEANING ROD WITH ROTATING T-HANDLE
- 3 STAR CHAMBER CLEANING PADS
- PATCHES FOR .22 OR .30 CAL
- NYLON BRUSHES FOR .22 OR .30 CAL
- JAGS FOR .22 OR .30 CAL
- SLOTTED TIP



PACKAGE

ITEM: 1084758
UPC: 661120414247

CASE PACK: 6



SINGLE POINT TACTICAL SLING KIT

PRODUCT FEATURES

SLING

- PREMIUM SPRING-LOADED CARABINER
- FLEXIBLE HIGH-DENSITY BUNGEE STRAP WITH NYLON COVER
- QUICK-DITCH SIDE RELEASE BUCKLE
- FULLY ADJUSTABLE
- AMBIDEXTROUS FOR ALL SHOOTERS

AR RECEIVER END PLATE

- AMBIDEXTROUS FOR ALL SHOOTERS
- ACCEPTS SNAP HOOK STYLE ATTACHMENTS
- ONE SOLID STEEL PLATE
- END PLATE MADE IN THE USA



PACKAGE

ITEM: 110030
UPC: 661120000297

CASE PACK: 6

AR-15 CUSTOMIZABLE LOWER PARTS

PRODUCT FEATURES

KIT INCLUDES:

- BOLT CATCH
- BOLT CATCH PLUNGER
- BOLT CATCH ROLL PIN
- BOLT CATCH SPRING
- BUFFER RETAINER
- BUFFER RETAINER SPRING
- HAMMER PIN
- MAGAZINE CATCH
- MAGAZINE CATCH BUTTON
- MAGAZINE CATCH SPRING
- PIVOT PIN
- PIVOT PIN DETENT
- PIVOT PIN DETENT SPRING
- SELECTOR
- SELECTOR DETENT
- SELECTOR DETENT SPRING
- TAKEDOWN PIN
- TAKEDOWN PIN DETENT
- TAKEDOWN PIN DETENT SPRING
- TRIGGER PIN



PACKAGE

ITEM: 110115
UPC: 661120001270

CASE PACK: 6

AR-15 COMPLETE LOWER PARTS KIT

PRODUCT FEATURES

KIT INCLUDES:

- BOLT CATCH
- BOLT CATCH PLUNGER
- BOLT CATCH ROLL PIN
- BOLT CATCH SPRING
- BUFFER RETAINER
- BUFFER RETAINER SPRING
- DISCONNECTOR
- DISCONNECTOR SPRING
- HAMMER
- HAMMER PIN
- HAMMER SPRING
- MAGAZINE CATCH
- MAGAZINE CATCH BUTTON
- MAGAZINE CATCH SPRING
- PISTOL GRIP
- PISTOL GRIP LOCK WASHER
- PISTOL GRIP SCREW
- PIVOT PIN
- PIVOT PIN DETENT
- PIVOT PIN DETENT SPRING
- SELECTOR
- SELECTOR DETENT
- SELECTOR DETENT SPRING
- TAKEDOWN PIN
- TAKEDOWN PIN DETENT
- TAKEDOWN PIN DETENT SPRING
- TRIGGER
- TRIGGER GUARD
- TRIGGER GUARD ROLL PIN
- TRIGGER PIN
- TRIGGER SPRING



PACKAGE

ITEM: 1085634
UPC: 661120412649

CASE PACK: 6



AR-15 COMPLETE UPPER PARTS KIT

PRODUCT FEATURES

KIT INCLUDES:

- FORWARD ASSIST - ASSEMBLED
- FORWARD ASSIST SPRING
- FORWARD ASSIST ROLL PIN
- EJECTION PORT COVER
- EJECTION PORT SPRING
- EJECTION PORT PIN
- HINGE PIN CLIP



PACKAGE

ITEM: 110116

UPC: 661120001287

CASE PACK: 6

PRODUCT FEATURES

KIT INCLUDES:

- BOLT CATCH PLUNGER
- BOLT CATCH SPRING
- BOLT CATCH ROLL PIN
- BUFFER RETAINER
- BUFFER RETAINER SPRING
- DISCONNECTOR SPRING
- HAMMER SPRING
- TRIGGER SPRING
- HAMMER PIN
- TRIGGER PIN
- PIVOT PIN DETENT
- PIVOT PIN DETENT SPRING
- TAKEDOWN PIN DETENT
- TAKEDOWN PIN DETENT SPRING
- SELECTOR DETENT
- SELECTOR DETENT SPRING
- TRIGGER GUARD ROLL PIN
- MAGAZINE CATCH SPRING



PACKAGE

ITEM: 1078425
UPC: 661120412687

CASE PACK: 6



M&P PISTOL NOVELTY MULTI-TOOL

PRODUCT FEATURES

- STAINLESS STEEL CONSTRUCTION
- 13 DIFFERENT TOOLS IN A COMPACT DESIGN
- INCLUDES ALUMINUM CARABINER

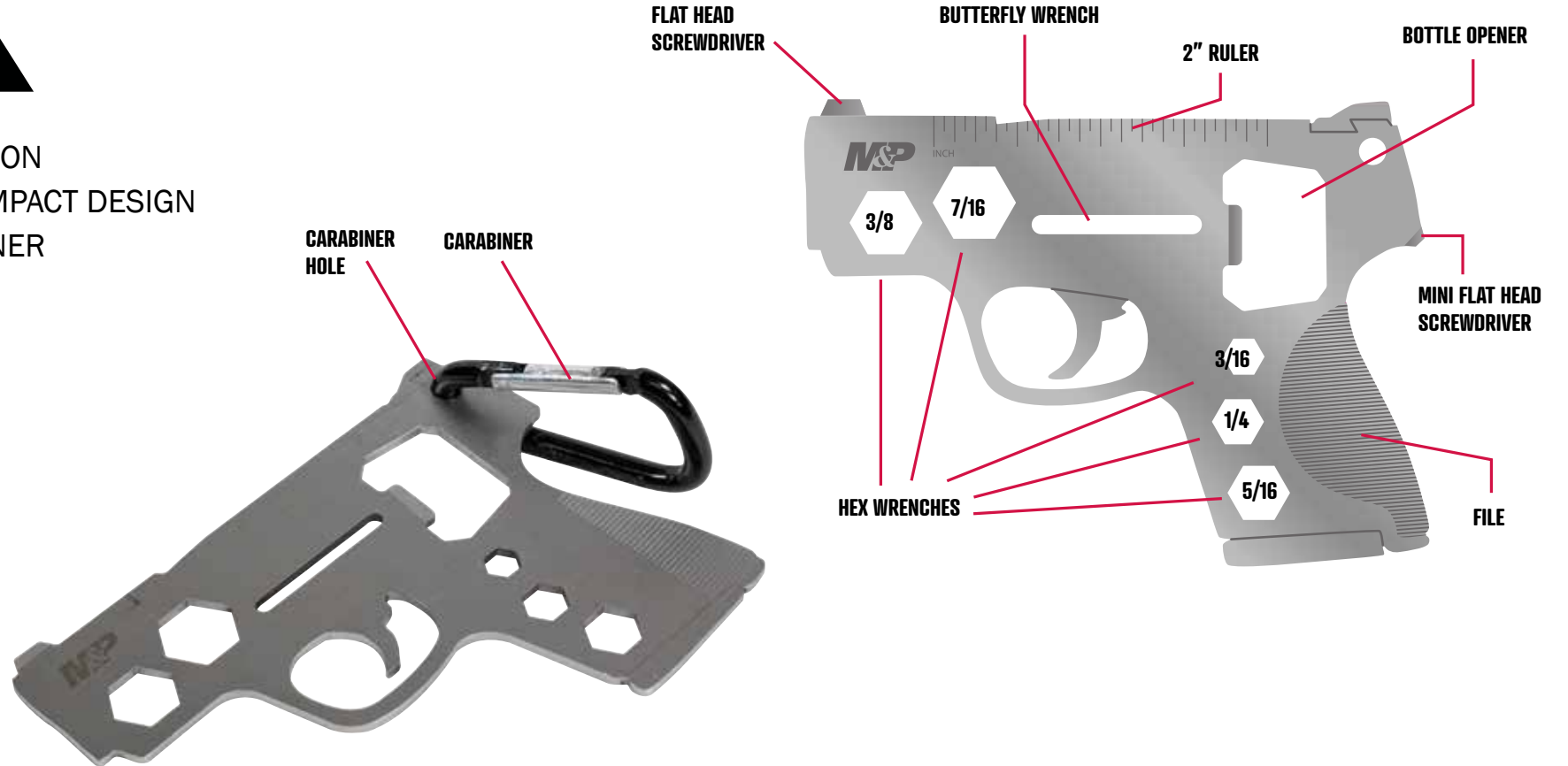

PACKAGE

ITEM: 1094693
UPC: 661120416081
CASE PACK: 6



SCREW CAP PEN BLACK

PRODUCT FEATURES

- T6061 AIRCRAFT ALUMINUM
- SCREW CAP PEN
- SCHMIDT P900M PARKER STYLE
BLACK BALL POINT PEN REFILL
- POCKET CLIP



WEIGHT: 1.4 OZ

BOX

ITEM: SWPENMP2BK
UPC: 28634704897

CASE PACK: 12



PULL CAP PEN BLACK

PRODUCT FEATURES

- T6061 AIRCRAFT ALUMINUM
- PULL CAP PEN
- SCHMIDT P900M PARKER STYLE
BLACK BALL POINT PEN REFILL
- POCKET CLIP



Overall Length: 6.1 in

WEIGHT: 1.4 OZ

**BLACK
-BOX**

ITEM: SWPENMPBK
UPC: 28634702961

CASE PACK: 24

**SILVER
-BOX**

ITEM: SWPENMPS
UPC: 28634702992

CASE PACK: 24



EYE AND EAR PROTECTION



THUNDERBOLT SHOOTING GLASSES

PRODUCT FEATURES

- ANSI Z87+ CERTIFIED
- IMPACT RESISTANT
- UV400 RATED
- MIL-PRF 32432 RATED
- FULL PERIPHERAL EYE COVERAGE
- ANTI-FOG LENSES
- HARD ZIPPERED STORAGE CASE WITH MICROFIBER CLOTH
- NON-REFLECTIVE MATTE BLACK FRAMES



Available in black frames with the following lenses:



SMOKE
#110166



AMBER
#110167



CLEAR MIRROR
#110168

**SMOKE
LENS**

ITEM: 110166
UPC: 661120001812

CASE PACK: 6

**AMBER
LENS**

ITEM: 110167
UPC: 661120001829

CASE PACK: 6

**CLEAR
MIRROR
LENS**

ITEM: 110168
UPC: 661120001836

CASE PACK: 6



SUPER COBRA SHOOTING GLASSES

PRODUCT FEATURES

- ANSI Z87+ CERTIFIED
- IMPACT RESISTANT
- UV400 RATED
- MIL-PRF 32432 RATED
- FULL PERIPHERAL EYE COVERAGE
- ANTI-FOG LENSES
- HARD ZIPPERED STORAGE CASE WITH MICROFIBER CLOTH
- NON-REFLECTIVE MATTE BLACK FRAMES
- NON-SLIP RUBBER NOSE & EAR PIECES



Available in black frames with the following lenses:



SMOKE

#110169



AMBER

#110170



CLEAR MIRROR

#110171

**SMOKE
LENS**

ITEM: 110169
UPC: 661120001843

CASE PACK: 6

**AMBER
LENS**

ITEM: 110170
UPC: 661120001850

CASE PACK: 6

**CLEAR
MIRROR
LENS**

ITEM: 110171
UPC: 661120001867

CASE PACK: 6



WHITEHAWK SHOOTING GLASSES

PRODUCT FEATURES

- ANSI Z87+ CERTIFIED
- IMPACT RESISTANT
- UV400 RATED
- MIL-PRF 32432 RATED
- FULL PERIPHERAL EYE COVERAGE
- ANTI-FOG LENSES
- HARD ZIPPERED STORAGE CASE WITH MICROFIBER CLOTH
- NON-SLIP RUBBER NOSE & EAR PIECES



Available in black frames with the following lenses:



SMOKE
#110172



BLUE MIRROR
#110173



CLEAR MIRROR
#110171

**SMOKE
MIRROR
LENS**

ITEM: 110172
UPC: 661120001874
CASE PACK: 6

**BLUE
MIRROR
LENS**

ITEM: 110173
UPC: 661120001881
CASE PACK: 6

**CLEAR
MIRROR
LENS**

ITEM: 110174
UPC: 661120001898
CASE PACK: 6



HARRIER INTERCHANGEABLE SHOOTING GLASSES

PRODUCT FEATURES

- ANSI Z87+ CERTIFIED
- IMPACT RESISTANT
- UV400 RATED
- FULL PERIPHERAL EYE COVERAGE
- ANTI-FOG LENSES
- 4 SETS OF INTERCHANGEABLE LENSES
- “ONE-TOUCH” LENS SWAPS
(NO FLEXING OR BENDING FRAMES TO REMOVE LENSES)
- HARD ZIPPERED STORAGE CASE WITH
3 MICROFIBER LENS BAGS
- NON-SLIP RUBBER NOSE & EAR PIECES



PACKAGE

ITEM: 110175
UPC: 661120001904

CASE PACK: 6



ALPHA ELECTRONIC EAR MUFF

PRODUCT FEATURES

- 23 NRR NOISE REDUCTION
- FOLDING COMPACT DESIGN
- PADDED HEADBAND
- LED ON INDICATOR LIGHT
- AUDIO INPUT JACK TO CONNECT PHONE OR MUSIC PLAYER
- ADJUSTABLE CUSHIONED EAR CUPS
- ANSI S3.19-1974 RATED
- AMPLIFIES LOW LEVEL SOUNDS
- COMPRESSES HIGH DB NOISES
- USES 2 AAA BATTERIES (INCLUDED)



PACKAGE

ITEM: 110041
UPC: 661120000488

CASE PACK: 6



FLASHLIGHTS



DELTA FORCE® CS-10 FLASHLIGHT

PRODUCT FEATURES

- CREE® XBH LED
- LENGTH: 4"
- HEAD DIAMETER: 0.81"
- WEIGHT: 2.05 OZ (W. BATTERIES)
- BATTERIES: 1 - AA BATTERY (INCLUDED)
- HIGH, LOW, STROBE AND MOMENTARY-ON FUNCTIONS
- MEMORY RETENTION REMEMBERS LAST LIGHT SETTING
- CONSTRUCTED FROM ANODIZED AEROSPACE ALUMINUM
- ON/OFF TAIL CAP SWITCH
- DUAL-FUNCTION SPRING STEEL CLIP ATTACHES TO POCKET, BELT OR HAT BILL
- CRENUATED HEAD FOR SELF DEFENSE

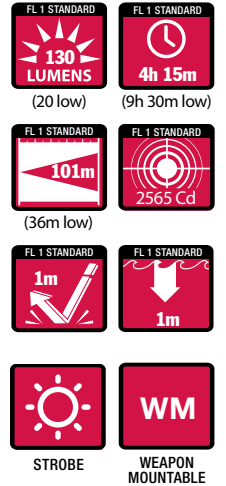

PACKAGE

ITEM: 110146
UPC: 661120001614
CASE PACK: 6





DELTA FORCE® CS-20 FLASHLIGHT

PRODUCT FEATURES

- CREE® XPG2 LED
- LENGTH: 3.5"
- HEAD DIAMETER: 0.81"
- WEIGHT: 2.54 OZ (W. BATTERY)
- BATTERIES: 1 - CR123 BATTERY (INCLUDED)
- HIGH, LOW, STROBE AND MOMENTARY-ON FUNCTIONS
- MEMORY RETENTION REMEMBERS LAST LIGHT SETTING
- CONSTRUCTED FROM ANODIZED AEROSPACE ALUMINUM
- ON/OFF TAIL CAP SWITCH
- DUAL-FUNCTION SPRING STEEL CLIP ATTACHES TO POCKET, BELT OR HAT BILL
- CRENUATED HEAD FOR SELF DEFENSE

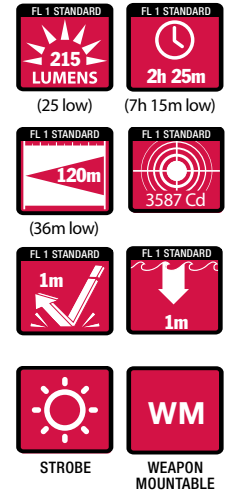

PACKAGE

ITEM: 110147
UPC: 661120001621
CASE PACK: 6





DELTA FORCE® HL-10 HEADLAMP

PRODUCT FEATURES

- CREE® XP-G2 R5 LED
- WEIGHT: 3.11 OZ (W. BATTERIES)
- BATTERIES: 3-AAA BATTERIES (INCLUDED)
- LIGHTWEIGHT, COMFORTABLE DESIGN
- LOW, MEDIUM, HIGH, TURBO-HIGH, STROBE AND S.O.S. MODES
- CONSTRUCTED FROM ANODIZED AEROSPACE ALUMINUM
- ONE-BUTTON CONTROL SWITCH FOR ONE-HANDED USE
- FULLY ADJUSTABLE HEADBAND

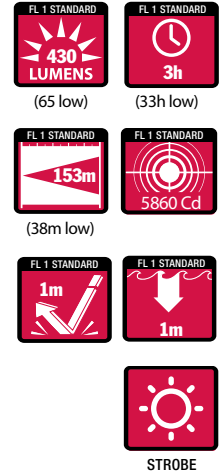

PACKAGE

ITEM: 110152
UPC: 661120001676
CASE PACK: 6





DUTY SERIES MS RXP 1X18650

PRODUCT FEATURES



- CREE® XPL LED
- LENGTH: 6"
- HEAD DIAMETER: 1.81"
- WEIGHT: 8.25 OZ (W. BATTERY)
- BATTERIES: 1 - 18650 RECHARGEABLE BATTERY (INCLUDED)
- INTERNAL 3400MAH BATTERY BANK CAN CHARGE CELL PHONES, LIGHTS OR OTHER ACCESSORIES
- LOW, MEDIUM, HIGH, TURBO AND S.O.S. FUNCTIONS
- MEMORY RETENTION REMEMBERS LAST LIGHT SETTING
- CONSTRUCTED FROM ANODIZED AEROSPACE ALUMINUM
- DIGITAL ON/OFF SWITCH WITH LOCKOUT FEATURE
- CRENULATED HEAD FOR SELF DEFENSE
- INCLUDES USB TO MICRO USB CHARGING CORD

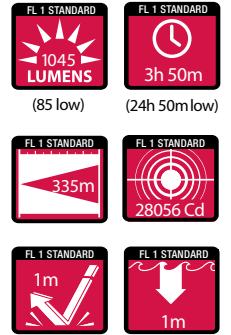

PACKAGE

ITEM: 1074566
UPC: 661120411079
CASE PACK: 6





DUTY SERIES CS RXP 1X18650 FLASHLIGHT

PRODUCT FEATURES



- CREE® XPL LED
- LENGTH: 4.65"
- HEAD DIAMETER: 1.25"
- WEIGHT: 3.32 OZ (W. BATTERIES)
- BATTERIES: 1- 18650 RECHARGEABLE BATTERY (INCLUDED)
- LOW, MEDIUM, HIGH, TURBO AND S.O.S. FUNCTIONS
- MEMORY RETENTION REMEMBERS LAST LIGHT SETTING
- CONSTRUCTED FROM ANODIZED AEROSPACE ALUMINUM
- DIGITAL ON/OFF SWITCH WITH LOCKOUT FEATURE
- DUAL-FUNCTION SPRING STEEL CLIP
- CRENULATED HEAD FOR SELF DEFENSE
- INCLUDES USB TO MICRO USB CHARGING CORD

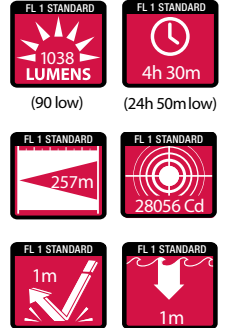

PACKAGE

ITEM: 1078451
UPC: 661120412144
CASE PACK: 6





DELTA FORCE® CS 1XAAA FLASHLIGHT

PRODUCT FEATURES

- CREE® XPG2 LED
- LENGTH: 4.0”
- HEAD DIAMETER: 0.70”
- WEIGHT: 1.41 OZ (W. BATTERY)
- BATTERIES: 1-AAA BATTERIES (INCLUDED)
- HIGH, LOW, STROBE AND MOMENTARY-ON FUNCTIONS
- MEMORY RETENTION REMEMBERS LAST LIGHT SETTING
- CONSTRUCTED FROM ANODIZED AEROSPACE ALUMINUM
- TAIL CAP ON/OFF SWITCH
- DUAL-FUNCTION SPRING STEEL CLIP
- CRENULATED HEAD FOR SELF DEFENSE

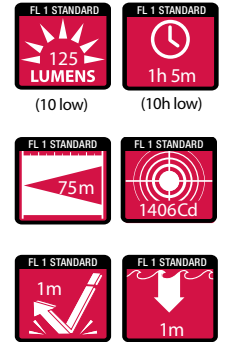

PACKAGE

ITEM: 1078454
UPC: 661120412168
CASE PACK: 6





DELTA FORCE® CS 2XAAA FLASHLIGHT

PRODUCT FEATURES

- CREE® XPG2 LED
- LENGTH: 5.83”
- HEAD DIAMETER: 0.70”
- WEIGHT: 2.12 OZ (W. BATTERIES)
- BATTERIES: 2-AAA BATTERIES (INCLUDED)
- HIGH, LOW, STROBE AND MOMENTARY-ON FUNCTION
- MEMORY RETENTION REMEMBERS LAST LIGHT SETTING
- CONSTRUCTED FROM ANODIZED AEROSPACE ALUMINUM
- TAIL CAP ON/OFF SWITCH
- SPRING STEEL CLIP
- CRENULATED HEAD FOR SELF DEFENSE

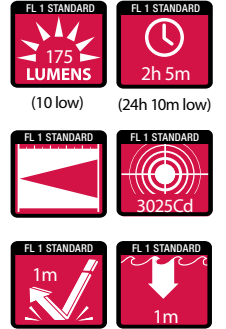

PACKAGE

ITEM: 1078455
UPC: 661120412571
CASE PACK: 6





DELTA FORCE® MS 2XAA FLASHLIGHT

PRODUCT FEATURES

- CREE® XPG2 LED
- LENGTH: 6.34"
- HEAD DIAMETER: 1.1"
- WEIGHT: 5.78 OZ (W. BATTERIES)
- BATTERIES: 2- AA BATTERIES (INCLUDED)
- HIGH, LOW, STROBE AND MOMENTARY-ON FUNCTIONS
- MEMORY RETENTION REMEMBERS LAST LIGHT SETTING
- CONSTRUCTED FROM ANODIZED AEROSPACE ALUMINUM
- TAIL CAP ON/OFF SWITCH
- CRENUATED HEAD FOR SELF DEFENSE

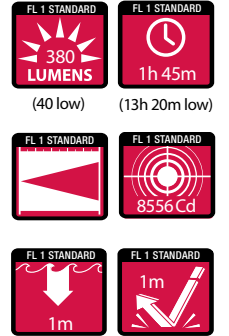

PACKAGE

ITEM: 1078456
UPC: 661120412588
CASE PACK: 6





DELTA FORCE[®] MS 2XCR123 FLASHLIGHT

PRODUCT FEATURES

- CREE[®] XPL LED
- LENGTH: 5.4"
- HEAD DIAMETER: 1.4"
- WEIGHT: 5.86 OZ (W. BATTERIES)
- BATTERIES: 2- CR123 BATTERIES (INCLUDED)
- HIGH, LOW, STROBE AND MOMENTARY-ON FUNCTIONS
- MEMORY RETENTION REMEMBERS LAST LIGHT SETTING
- CONSTRUCTED FROM ANODIZED AEROSPACE ALUMINUM
- TAIL CAP ON/OFF SWITCH
- CRENULATED HEAD FOR SELF DEFENSE
- WEAPON-MOUNTABLE USING 1" RING

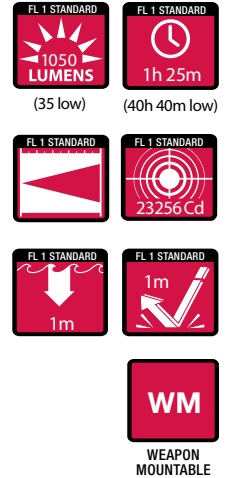

PACKAGE

ITEM: 1078457
UPC: 661120412595
CASE PACK: 6





DELTA FORCE® CS 2XCR123 FLASHLIGHT

PRODUCT FEATURES

- CREE® XPG2 LED
- LENGTH: 4.8”
- HEAD DIAMETER: 0.95”
- WEIGHT: 2.82 OZ (W. BATTERIES)
- BATTERIES: 2- CR123 BATTERIES (INCLUDED)
- HIGH, LOW, STROBE AND MOMENTARY-ON FUNCTIONS
- MEMORY RETENTION REMEMBERS LAST LIGHT SETTING
- CONSTRUCTED FROM ANODIZED AEROSPACE ALUMINUM
- TAIL CAP ON/OFF SWITCH
- SPRING STEEL CLIP
- CRENULATED HEAD FOR SELF DEFENSE

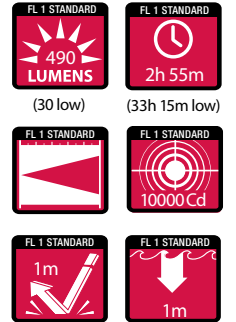

PACKAGE

ITEM: 1078458
UPC: 661120412601

CASE PACK: 6



DUTY SERIES MS RXP 1X18650 BATTERY BANK

PRODUCT FEATURES



- CREE® XPL LED
- LENGTH: 5.9"
- HEAD DIAMETER: 1.57"
- WEIGHT: 7.41 OZ (W. BATTERY)
- BATTERIES: 1- 18650 RECHARGEABLE BATTERY (INCLUDED)
- LOW, HIGH, STROBE AND MOMENTARY-ON FUNCTIONS
- MEMORY RETENTION REMEMBERS LAST LIGHT SETTING
- CONSTRUCTED FROM ANODIZED AEROSPACE ALUMINUM
- TAIL CAP ON/OFF SWITCH
- CRENULATED HEAD FOR SELF DEFENSE
- LANYARD CARRY STRAP (INCLUDED)
- INCLUDES USB TO MICRO USB CHARGING CORD

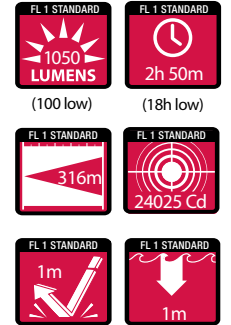

PACKAGE

ITEM: 1081076
UPC: 661120412618

CASE PACK: 6





NIGHT TERROR® SLIM FLASHLIGHT

PRODUCT FEATURES



- CREE® XHP 70.2 LED
- LENGTH: 9.65"
- HEAD DIAMETER: 2.2"
- WEIGHT: 17.64 OZ (W. BATTERIES)
- BATTERIES: 2 - 18650 RECHARGEABLE BATTERIES (INCLUDED)
- TRIPOD MOUNTABLE
- LOW, MEDIUM, HIGH, TURBO-HIGH, STROBE AND SOS FUNCTIONS
- CONSTRUCTED FROM ANODIZED AEROSPACE ALUMINUM
- DIGITAL ON/OFF SWITCH WITH LOCK OUT FEATURE
- CRENULATED HEAD FOR SELF DEFENSE
- RUBBER TEXTURED GRIP
- INCLUDES USB TO MICRO USB CHARGING CORD

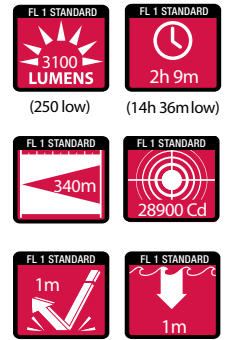

PACKAGE

ITEM: 1081077
UPC: 661120412625

CASE PACK: 6





NIGHT TERROR® COMPACT FLASHLIGHT

PRODUCT FEATURES



- CREE® XHP 70.2 LED
- LENGTH: 6.2"
- HEAD DIAMETER: 1.76"
- WEIGHT: 7.83 OZ (W. BATTERIES)
- BATTERIES: 1 - INR 18650 RECHARGEABLE (INCLUDED)
- LOW, MEDIUM, HIGH, TURBO-HIGH, STROBE AND SOS FUNCTIONS
- MEMORY RETENTION REMEMBERS LAST LIGHT SETTING
- ANODIZED AEROSPACE ALUMINUM CONSTRUCTION
- DIGITAL ON/OFF SWITCH WITH LOCKOUT FEATURE
- CRENULATED HEAD FOR SELF DEFENSE
- RUBBER TEXTURED GRIP
- INCLUDES USB TO MICRO USB CHARGING CORD

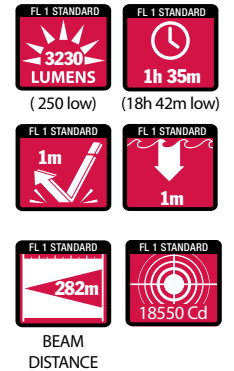

PACKAGE

ITEM: 1097919
UPC: 661120417477

CASE PACK: 6





NIGHT TERROR[®] HEADLAMP

PRODUCT FEATURES

- HIGH OUTPUT LED
- LENGTH: 4"
- DEPTH: 1.75"
- BATTERIES: 1 - 18650 RECHARGEABLE BATTERY (INCLUDED)
- LOW, MEDIUM, HIGH, TURBO HIGH, S.O.S., STROBE FUNCTIONS
- CONSTRUCTED FROM ANODIZED AEROSPACE ALUMINUM
- ILLUMINATED POWER INDICATOR
- 180° LIGHT ROTATION ON HEADBAND
- INCLUDES USB TO MICRO USB CHARGING CORD

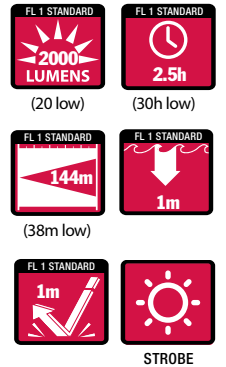

PACKAGE

ITEM: 1117195
UPC: 661120080732
CASE PACK: 4





OFFICER® RXP FLASHLIGHT

PRODUCT FEATURES



- CREE® XPL HD V5 LED
- LENGTH: 5.6"
- HEAD DIA: 1.3"
- WEIGHT: 5.6 OZ (W. BATTERIES)
- BATTERIES: 1 - 18650 RECHARGEABLE BATTERY (INCLUDED)
- ADJUSTABLE HOLSTER WITH RETENTION (INCLUDED)
- 2 USB CHARGING STATIONS (INCLUDED)
- ANODIZED AEROSPACE ALUMINUM CONSTRUCTION
- CHARGES AUTOMATICALLY WHEN PLACED INTO CHARGING STATION
- CRENULATED HEAD FOR SELF DEFENSE



MECHANICAL RECESSED TAILCAP SWITCH WITH MOMENTARY ON FEATURE

TYPE III HARDCOAT ANODIZED ALUMINUM CONSTRUCTION



CREE® XPL HD V5 LED

QUICKLY AND EASILY RECHARGE FROM THE CHARGING STATION

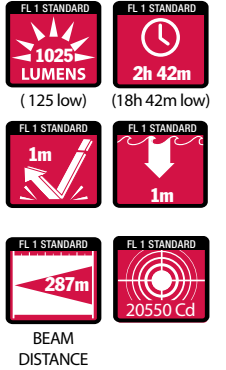

INCLUDES ADJUSTABLE HOLSTER WITH RETENTION

2 USB CHARGING STATIONS INCLUDED



PACKAGE

ITEM: 1098726
UPC: 661120417484

CASE PACK: 6



OFFICER[®] ADJUSTABLE FLASHLIGHT HOLSTER

PRODUCT FEATURES

- ULTRA DURABLE GLASS-FILLED NYLON CONSTRUCTION
- RETENTION ARMS FIRMLY HOLD FLASHLIGHT IN ANY POSITION, EVEN WHILE RUNNING
- FLASHLIGHT IS QUICKLY REMOVABLE WHEN NEEDED
- 360° ROTATION WITH 26 DETENT POSITIONS
- QUICK-RELEASE BELT CLIP FITS BELTS UP TO 2.25" W
- PERFECTLY DESIGNED FOR M&P[®] OFFICER FLASHLIGHT AND OTHER M&P[®] DELTA FORCE[®] MS LIGHTS
- FITS STREAMLIGHT[®] STRION[®] AND OTHER LIGHTS WITH 26-35MM BEZELS
- OPEN BOTTOM ALLOWS LIGHT TO BE USED WHILE STILL IN HOLSTER

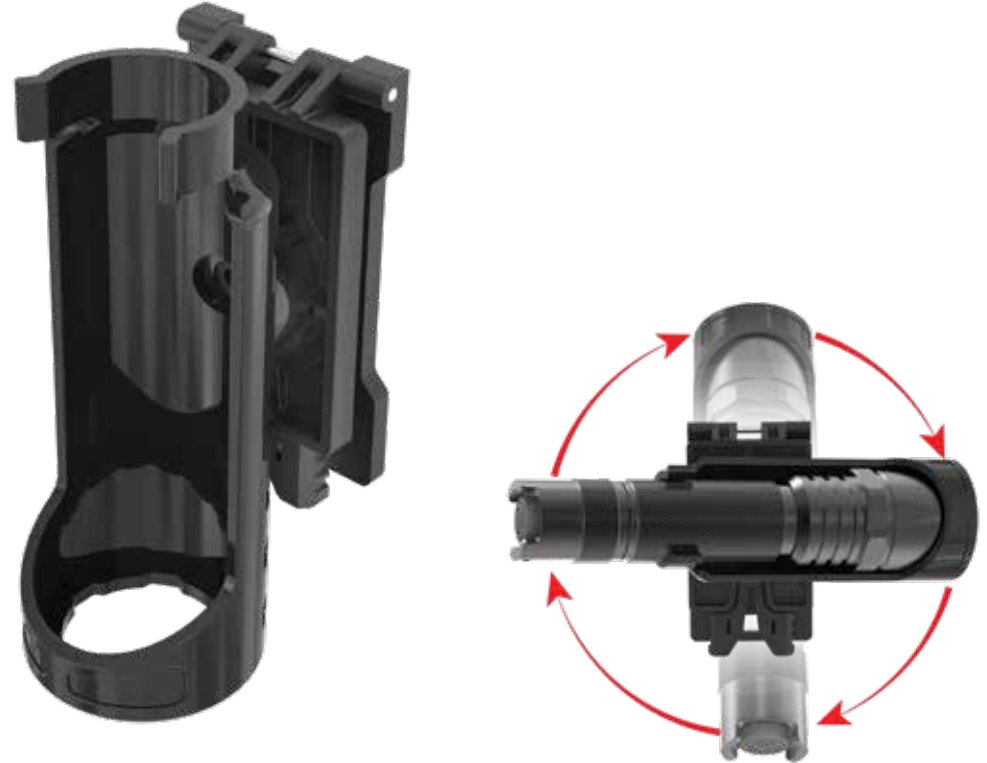

PACKAGE

ITEM: 1098727
UPC: 661120417064

CASE PACK: 6



M&P[®]

by **Smith & Wesson**[®]

Smith & Wesson[®], M&P[®] and M2.0[®] are trademarks of Smith & Wesson Brands, Inc. used under license.