



**Smith & Wesson®**

**2024 PRODUCT CATALOG**

✦ CUTLERY ✦





**Built to protect a legacy,  
Smith & Wesson® provides  
authentic products to help the  
courageous defend against  
life's biggest adversaries.**



 Smith & Wesson®

 Smith & Wesson®

**2024 NEW PRODUCTS**

# BULLSEYE® PRO THROWING AXE

CLAMSHELL ITEM: 1205004 UPC: 661120750321

The Bullseye® Pro Throwing Axe is custom designed for competitive axe throwing and meets all the WATL regulations. This axe will maximize any competitor's score with a 4" bit, larger beard and smooth release handle. The proprietary replaceable handle lets users replace or customize the handle with ease or even swap them during a match.

## PRODUCT FEATURES

- Custom Designed Forged Axe Head to Improve Throwing League Score
- User-Replaceable Handle for Increased Durability and Easy Repair or Replacement
- Meets WATL (World Axe Throwing League) Regulations
- 1065 Blade Steel for a Long Lasting Axe Head

BLADE LENGTH: 4 IN

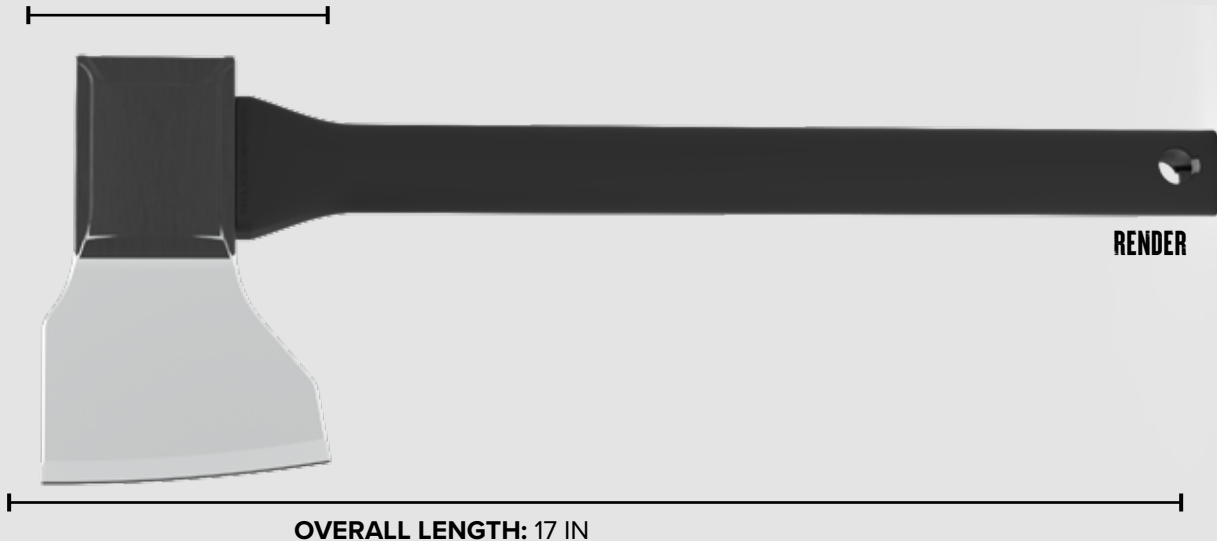



# BULLSEYE® THROWING BOWIE

CLAMSHELL ITEM: 1205005 UPC: 661120750338



Smith and Wesson continues to dominate the recreational knife throwing market and is broadening their assortment of throwing products with the Bullseye Bowie. This bowie provides throwing forgiveness with a dual pointed ends throwing tool to increase chances of sticking.

## PRODUCT FEATURES

- 3cr Stainless Steel for Ultimate Toughness
- 2 Pack
- Custom Balanced With Dual Pointed Ends for Easier Throwing
- Polyester Sheath for Safe and Easy Transportation



# EXTREME OPS® SPRING ASSIST KARAMBIT



**BLISTER ITEM:** 1205008 **UPC:** 661120750352  
**BOX ITEM:** 1208411 **UPC:** 661120750680

The unique shape of the Extreme Ops® Spring Assist Karambit will catch the eye of anyone looking to add to their knife collection. With the spring assist, finger flipper, thumb stud, and pocket hook, this karambit offers a variety of ways to open quickly out of pocket, making it perfect for EDC or tactical use.

## PRODUCT FEATURES

- 8Cr Blade Steel for Edge Retention and Corrosion Resistance
- True Karambit Blade Shape for Tactical Use
- Finger Loop for Retention
- Assisted Blade for Fast Deployment
- G10 Handles for Extra Grip and Comfort



**HANDLE LENGTH: 5 IN**

**BLADE LENGTH: 3 IN**



**OVERALL LENGTH: 7.5 IN**



# EXTREME OPS® FIXED BLADE KARAMBIT



**BLISTER ITEM:** 1205007 **UPC:** 661120750345  
**BOX ITEM:** 1208412 **UPC:** 661120750697

The unique shape of this fixed blade Karambit will catch the eye of anyone looking to add to their knife collection. The full tang offers a solid grip and increases durability, making it perfect for EDC or tactical uses.

## PRODUCT FEATURES

- 8Cr Blade Steel for Edge Retention and Corrosion Resistance
- True Karambit Blade Shape for Tactical Use
- Finger Loop for Retention
- Polymer Molded Sheath for Quick Deployment
- G10 Handles for Extra Grip and Comfort



**BLADE LENGTH: 3.25 IN**



**OVERALL LENGTH: 7 IN**



# UNWAVERED™ - SPRING ASSIST FOLDING DAGGER



**BLISTER ITEM:** 1205011 **UPC:** 661120750444  
**BOX ITEM:** 1208413 **UPC:** 661120750727

Expanding on the Unwavered family and its nod to the history and tradition of Smith & Wesson firearms, introducing the Spring Assist Folding Dagger. Featuring checkered rosewood inset into stainless steel scales, a finger flipper, single edged dagger profile, and laser engraving, the Unwavered™ – Spring Assist Folding Dagger is a blend of classic and modern that is sure to impress.

## PRODUCT FEATURES

- 8Cr Blade Steel for Edge Retention and Corrosion Resistance
- Liner Lock Mechanism for a Solid Lock Up
- Reversible Pocket Clip for Easy Carry
- Spring Assisted for Easy Deployment
- Rosewood and Stainless Steel Handle With a Laser Engraved Pattern for a Timeless, Firearm Inspired Look



**HANDLE LENGTH: 4.25 IN**

**BLADE LENGTH: 3.5 IN**



**OVERALL LENGTH: 7.75 IN**



# EXTRACTION & EVASION® ASSISTED CLEAVER



**BLISTER ITEM:** 1205012 **UPC:** 661120750376  
**BOX ITEM:** 1208414 **UPC:** 661120750673

Modeled after the fan favorite machete cleaver, the Extraction & Evasion® Cleaver is a folding knife designed with hard use in mind. With textured non-slip aluminum handles and a tall cleaver blade design, this knife is a robust addition to anyone looking for a larger folder that is ready for any task.

## PRODUCT FEATURES

- 8Cr Blade Steel for Edge Retention and Corrosion Resistance
- Black Oxide Coated Stainless Steel Blade
- Spring Assisted With Finger Flipper for Quick, Consistent Deployment
- Aluminum Scales With Rubberized Finish for a Secure Grip During Use



HANDLE LENGTH: 5 IN

BLADE LENGTH: 3.5 IN



OVERALL LENGTH: 8.5 IN

# EXECUTIVE PLATINUM



**BLISTER ITEM:** 1205009 **UPC:** 661120750369  
**BOX ITEM:** 1208415 **UPC:** 661120750666

The Executive Platinum knife joins the already popular executive line of knives, bringing a classy look to everyday carry. With a 8Cr Blade and Stainless Steel handle the Executive Platinum is a classy EDC that is ready for any task.

## PRODUCT FEATURES

- 8Cr Blade Steel for Edge Retention and Corrosion Resistance
- Sleek Stainless Steel Drop Point Blade and Handle for a Clean Professional Look
- Frame Lock With Overtravel Stop for Strong, Dependable Lockup
- Swappable Pocket Clip for Left or Right-Handed Carry



**HANDLE LENGTH: 4.25IN**

**BLADE LENGTH: 3 IN**



**OVERALL LENGTH: 7.25 IN**



# OASIS® CARABINER FOLDING KNIFE



**BLISTER ITEM:** 1206288 **UPC:** 661120750406  
**BOX ITEM:** 1208418 **UPC:** 661120750710

The Oasis was designed with the outdoor enthusiast in mind. Its carabiner style clip can be attached to bags, belts, straps and more. The 8Cr steel will hold an edge when you need it and keep the blade from corrosion. This all comes at a desirable price point which makes this knife an incredible value.

## PRODUCT FEATURES

- 8Cr Blade Steel for Edge Retention and Corrosion Resistance
- Carabiner for Versatile Carry Options
- Liner Lock Mechanism for Sturdy Lockup
- Finger Flipper for Quick, Consistent Deployment
- Aluminum Scales



**HANDLE LENGTH: 4 IN**

**BLADE LENGTH: 3 IN**

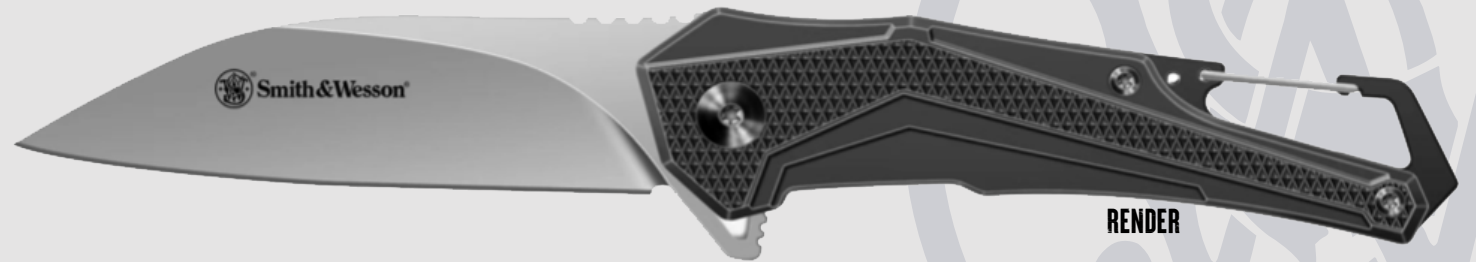

**OVERALL LENGTH: 7 IN**

# EXTREME OPS® SPRING ASSIST TANTO



**BLISTER ITEM:** 1206286 **UPC:** 661120750383  
**BOX ITEM:** 1208416 **UPC:** 661120750703

The Extreme Ops® Tanto was designed for those on a budget, without sacrificing quality. With 8Cr steel this knife can withstand any task at hand. The scales are textured for grip and boasts an assisted finger flipper action for quick and easy use. This all comes at a desirable price point which makes this a must have for a budget EDC option.

## PRODUCT FEATURES

- 8Cr Blade Steel for Edge Retention and Corrosion Resistance
- Pocket Clip for Easy Carry
- Liner Lock Mechanism for Sturdy Lockup
- Assisted Open for Faster Extraction
- Machined Aluminum Scales for a Solid Grip



**HANDLE LENGTH: 3.5 IN**

**BLADE LENGTH: 2.5 IN**



**OVERALL LENGTH: 6 IN**

# 24/7<sup>®</sup> SPRING ASSIST



**BLISTER ITEM:** 1206287 **UPC:** 661120750390  
**BOX ITEM:** 1208417 **UPC:** 661120750659

The 24/7<sup>®</sup> Spring Assist follows the style of the popular 24/7<sup>®</sup> family of knives and it brings a lot to the table in a small package. A sleek, blacked-out look with a pop of red in the pivot collar and back spacer gives some contrast to this attractive, little sidekick.

## PRODUCT FEATURES

- 8Cr Blade Steel for Edge Retention and Corrosion Resistance.
- Pocket Clip for Easy Carry
- Liner Lock Mechanism for Sturdy Lockup
- Machined Aluminum Scales for a Solid Grip
- Spring Assisted for Faster Deployment



**HANDLE LENGTH: 3 IN**

**BLADE LENGTH: 1.9 IN**



**OVERALL LENGTH: 4.9 IN**

# EXTREME OPS® TANTO WITH GLASS BREAKER



BLISTER ITEM: 1205907 UPC: 661120749721

The Extreme Ops® Tanto is a sleek, tactical oriented folder featuring a tanto point on a bearing pivot. Finger flipper and thumb stud offer multiple options for deployment while the reversible pocket clip allows for left or right-handed carry.

## PRODUCT FEATURES

- 7Cr Blade Steel for Chosen for Edge Holding and Corrosion Resistance
- Reversible Pocket Clip for Easy Carry
- Liner Lock Mechanism for Sturdy Lockup
- Machined Aluminum Scales for a Solid Grip
- Bearing Pivot for Quick, Smooth Deployment



HANDLE LENGTH: 5 IN

BLADE LENGTH: 3.5 IN



OVERALL LENGTH: 8.5 IN

RENDER



# EXTREME OPS® TWO-TONE DROP POINT



BLISTER ITEM: 1205905 UPC: 661120749783

The Extreme Ops® Two-Tone Drop Point is suited for any tactical situation. Featuring textured, aluminum scales for a solid feeling grip that can hold up to any task. Finger flipper and thumb stud offer multiple options for deployment. An attractive two-tone blade made from 3Cr will hold a great edge and resist corrosion.

## PRODUCT FEATURES

- 3Cr Blade for Toughness
- Pocket Clip for Easy Carry
- Liner Lock Mechanism for Sturdy Lockup
- Machined Aluminum Scales for a Solid Grip
- Bearing Pivot for Quick, Smooth Deployment
- Finger Flipper and Thumb Stud for Multiple Opening Options



BLADE LENGTH: 3 IN



RENDER



HANDLE LENGTH: 4 IN

OVERALL LENGTH: 7 IN

# EXTREME OPS® SPRING ASSISTED DROP POINT



BLISTER ITEM: 1205911 UPC: 661120749738

The Extreme Ops® Spring Assisted Drop Point is a lightweight solution with no compromises. The Spring Assisted 7Cr blade allows for lightning fast deployment while the textured handle ensures a tight grip. The Black and Tan color combo matches your tactical load out.

## PRODUCT FEATURES

- 7Cr Blade Steel for Edge Retention and Corrosion Resistance
- Tip Down Pocket Clip for Easy Carry
- Liner Lock Mechanism for Sturdy Lockup
- Polymer Scales for a Lightweight, Solid Grip
- Spring Assisted With Bearings for Faster Deployment



HANDLE LENGTH: 4.5 IN

BLADE LENGTH: 3.25 IN



RENDER

OVERALL LENGTH: 7.75 IN

# S.W.A.T.® SPRING ASSISTED DROP POINT



BLISTER ITEM: 1205909 UPC: 661120749745

The S.W.A.T.® Spring Assisted Drop Point offers a lot of features in a lightweight package. The 7Cr blade is spring assisted for quick deployment while the ball bearings keep things nice and smooth. Textured, polymer scales match the grip of your tactical carry while blending in unnoticed.

## PRODUCT FEATURES

- 7Cr Blade Steel for Edge Retention and Corrosion Resistance
- Pocket Clip for Easy Carry
- Liner Lock Mechanism for Sturdy Lockup
- Polymer Scales for a Lightweight, Solid Grip
- Spring Assisted With Bearings for Faster Deployment

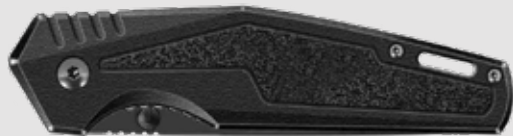

HANDLE LENGTH: 4 IN

BLADE LENGTH: 3 IN



RENDER

OVERALL LENGTH: 7 IN

# SPECIAL OPS® SERRATED CLIP POINT



BLISTER ITEM: 1205913 UPC: 661120749752

The Special Ops® Serrated Clip Point is a larger knife with plenty of traction for a secure grip during any task. The ultra fast deployment comes from dual thumb studs and pivot bearings. Blade and liner lock jimping and lightweight grips ensure your hand won't slip during tactical use.

## PRODUCT FEATURES

- 7Cr Blade Steel for Edge Retention and Corrosion Resistance
- Pocket Clip for Easy Carry
- Liner Lock Mechanism for Sturdy Lockup
- Polymer Scales for a Lightweight, Solid Grip
- Bearing Pivot for Quick, Smooth Deployment



HANDLE LENGTH: 4.68 IN

BLADE LENGTH: 3 IN



RENDER

OVERALL LENGTH: 8 IN



# BLACK OPS® RECURVE FOLDER



BLISTER ITEM: 1205899 UPC: 661120749820

The Black Ops® Recurve Folder switches things up with a sleek grip and unique recurve blade. The inset liner lock keeps the profile slim and lightweight to fit into your EDC rotation while the pivot bearings allow for a quick and consistent deployment.

## PRODUCT FEATURES

- 7Cr Blade Steel for Edge Retention and Corrosion Resistance
- Pocket Clip for Easy Carry
- Liner Lock Mechanism for Sturdy Lockup
- Polymer Scales for a Lightweight, Solid Grip
- Bearing Pivot for Quick, Smooth Deployment



HANDLE LENGTH: 4.5 IN

BLADE LENGTH: 3 IN

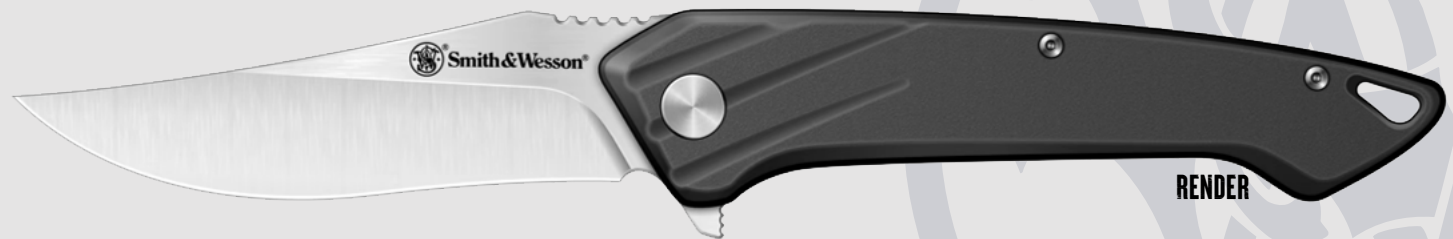

RENDER

OVERALL LENGTH: 7.5 IN

# BLACK OPS® CLIP POINT FOLDER



BLISTER ITEM: 1205914 UPC: 661120749790

The Black Ops® Clip Point Folder is a sleek knife with a larger, ergonomic profile. Machined aluminum scales give a solid feel without adding a lot of weight, while providing plenty of grip. The 3Cr blade sports a fine tip for precision cutting tasks without compromising durability.

## PRODUCT FEATURES

- 3Cr Blade Steel for Toughness
- Pocket Clip for Easy Carry
- Liner Lock Mechanism for Sturdy Lockup
- Aluminum Scales for a Solid Grip
- Bearing Pivot for Quick, Smooth Deployment



HANDLE LENGTH: 4.5 IN

BLADE LENGTH: 3.5 IN



RENDER

OVERALL LENGTH: 8 IN



# 24/7<sup>®</sup> CROSSBAR FOLDER



BLISTER ITEM: 1205908 UPC: 661120749868

The 24/7<sup>®</sup> Crossbar Folder is a gentleman's carry with a slim profile and premium features. The robust crossbar lock offers ambidextrous opening and closing while ensuring a secure lock up. A deep carry clip sits low in the pocket and is also reversible for left or right-handed carry.

## PRODUCT FEATURES

- 7Cr Blade Steel for Edge Retention and Corrosion Resistance
- Reversible Pocket Clip for Easy Carry
- Polymer Scales for a Lightweight, Solid Grip
- Bearing Pivot for Quick, Smooth Deployment
- Crossbar Lock Mechanism for Extreme Strength and One-Handed Use



HANDLE LENGTH: 4.5 IN

BLADE LENGTH: 3.25 IN



RENDER

OVERALL LENGTH: 7.75 IN



Smith & Wesson®

**2024 RETURNING PRODUCTS**





Smith & Wesson®

**FOLDING KNIVES**

# UNWAVERED™



BLISTER ITEM: 1193149 UPC: 661120655480  
BOX ITEM: 1193150 UPC: 661120655497

Unwavering, just like the carrier. This classic knife stands steadfast and prepared for anything. With a modified drop point blade for versatile use, a spring assisted opening is made for quick and easy access, a liner lock for easy one-handed close, and an engraved handle, this knife is perfect for anyone who wants a reliable and trustworthy blade.

## PRODUCT FEATURES

- Modified drop point blade for versatile use
- Assisted opening for quick and easy access
- Liner lock for easy one handed close
- Finger flipper for easy access



HANDLE LENGTH: 4.5 IN

BLADE LENGTH: 3.25 IN



OVERALL LENGTH: 7.75 IN

# 1ST RESPONSE® DROP SILVER/BLACK



## DROP POINT

BOX ITEM: SWFR UPC: 28634700677

## DROP POINT SERRATED

BOX ITEM: SWFRS UPC: 28634700684

BLISTER ITEM: SWFRSCP UPC: 28634701391

The 1st Response® Liner Lock Folding Knife is made out of a high carbon stainless steel drop point blade with an ambidextrous thumb disc. Its stainless-steel handle comes with black G-10 inlay, a glass breaking tool, strap cutter, and pocket clip.

## PRODUCT FEATURES

- Stainless Steel with G-10 Inlay Handle
- High Carbon Stainless Steel Blade
- Thumb Plate
- Liner Lock
- Strap Cutter
- Glass Breaker
- Pocket Clip
- Weight: 5.8 oz



HANDLE LENGTH: 4.7 IN



BLADE LENGTH: 3.3 IN

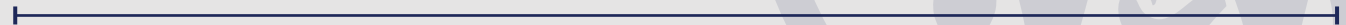

OVERALL LENGTH: 8 IN



Drop Point Serrated Blade Option

# DROP POINT SERRATED BIRDSEYE



## SILVER/BLACK

BOX ITEM: SW608S UPC: 28634709175

## BLACK/BLUE

BOX ITEM: SW608BLS UPC: 286347009199

## PRODUCT FEATURES

- Aluminum Handle
- Black Oxide High Carbon Stainless Steel Blade
- Index Flipper
- Liner Lock
- Strap Cutter
- Glass Breaker
- Pocket Clip
- Weight: 4.3oz



**EDGE RETENTION**  
**8CR**



HANDLE LENGTH: 5 IN



BLADE LENGTH: 3.4 IN



OVERALL LENGTH: 8.5 IN



# MODEL 325 REVOLVER KNIFE

BLISTER ITEM: 1168583 UPC: 661120265382



## PRODUCT FEATURES

- Finger Flipper
- Frame Lock
- Leather Holster
- Stainless Steel Blade
- Dual Thumb Studs



HANDLE LENGTH: 4.5 IN

BLADE LENGTH: 3 IN



OVERALL LENGTH: 7.5 IN



# SW1101 DROP POINT BLACK



BOX ITEM: 1084308 UPC: 661120413332  
BLISTER ITEM: 1084309 UPC: 661120413349

## PRODUCT FEATURES

- Rubberized Textured Aluminum Handle
- Black Oxide High Carbon Stainless Steel Blade
- Dual Thumb Studs
- Liner Lock
- Finger Flipper
- Pocket Clip
- Lanyard Hole
- Weight: 4.4oz



HANDLE LENGTH: 4 IN



BLADE LENGTH: 3 IN

OVERALL LENGTH: 6.89 IN

# SW1100 DROP POINT



BOX ITEM: 1084306 UPC: 661120413318  
BLISTER ITEM: 1084307 UPC: 661120413325

## PRODUCT FEATURES

- Aluminum with Textured Insert Handle
- Satin Finish High Carbon Stainless Steel Blade
- Dual Thumb Studs
- Frame Lock
- Finger Flipper
- Pocket Clip
- Lanyard Hole
- Weight: 3.1oz



HANDLE LENGTH: 3.74 IN



BLADE LENGTH: 2.75 IN

OVERALL LENGTH: 6.3 IN

# SW1103 DROP POINT FDE



BOX ITEM: 1084312 UPC: 661120413677  
BLISTER ITEM: 1084313 UPC: 661120413684

## PRODUCT FEATURES

- Glass Filled Textured Nylon Handle
- Black Oxide High Carbon Stainless Steel Blade
- Dual Thumb Studs
- Liner Lock
- Finger Flipper
- Pocket Clip
- Lanyard Hole
- Weight: 3.7oz



HANDLE LENGTH: 4.53 IN



# STONEWASHED DROP POINT



BOX ITEM: SW609 UPC: 28634709212  
BLISTER ITEM: SW609CP UPC: 28634709229

## PRODUCT FEATURES

- Stonewash G-10 Handle
- High Carbon Stainless Steel Blade
- Finger Flipper
- Frame Lock
- Pocket Clip
- Weight 5.9 oz

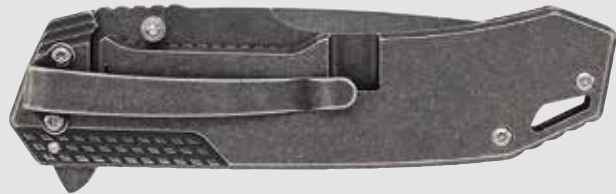

HANDLE LENGTH: 4.75 IN



BLADE LENGTH: 3.6 IN

OVERALL LENGTH: 8.3 IN



# SPECIAL TACTICAL<sup>®</sup> TANTO POINT



BOX ITEM: CKTAC UPC: 028634000753

## PRODUCT FEATURES

- ABS with Rubber Coating Handle
- High Carbon Stainless Steel
- Dual Thumb Studs
- Liner Lock
- Finger Flipper
- Pocket Clip
- Lanyard Hole
- Weight: 3.5oz



HANDLE LENGTH: 4.6 IN



BLADE LENGTH: 3.5 IN



OVERALL LENGTH: 8.1 IN

# SPECIAL TACTICAL® SERRATED



## TANTO POINT SERRATED

BOX ITEM: CKTACBS UPC: 028634000784

BLISTER ITEM: CKTACBSCP UPC: 028634700226

## DROP POINT SERRATED

BOX ITEM: CKTACBSD UPC: 028634700740

BLISTER ITEM: CKTACBSDCP UPC: 028634704385

## PRODUCT FEATURES

- ABS with Rubber Coating Handle
- High Carbon Stainless Steel
- Dual Thumb Studs
- Liner Lock
- Finger Flipper
- Pocket Clip
- Lanyard Hole
- Weight: 3.5oz



HANDLE LENGTH: 4.6 IN

BLADE LENGTH: 3.5 IN



OVERALL LENGTH: 8.1 IN



Drop Point Serrated Blade Option

# BORDER GUARD® SERRATED STONEWASH



BOX ITEM: SWBG10S UPC: 28634708550

BLISTER ITEM: SWBG10SCP UPC: 28634708888

## PRODUCT FEATURES

- Stonewash Aluminum G-10 Handle
- High Carbon Stainless Steel Blade
- Dual Thumb Studs
- Liner Lock
- Index Flipper
- Strap Cutter
- Glass Breaker
- Pocket Clip
- Weight: 6oz



HANDLE LENGTH: 4.8 IN

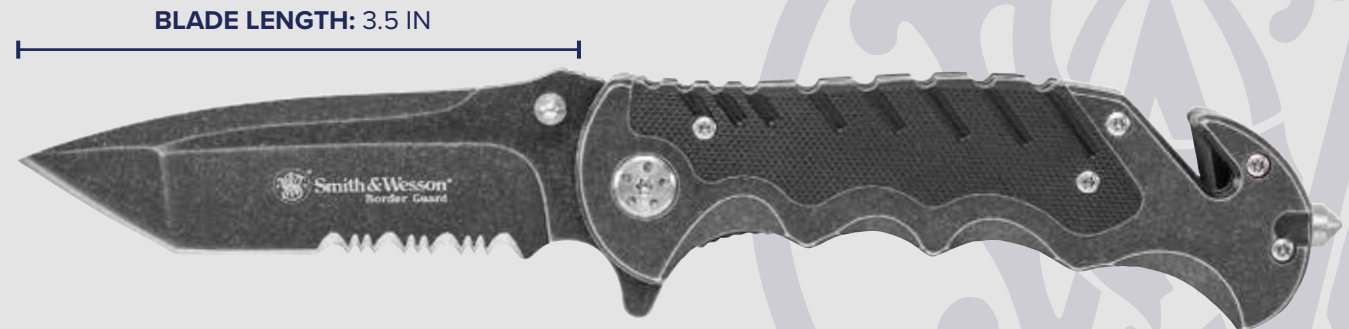

BLADE LENGTH: 3.5 IN

OVERALL LENGTH: 8.3 IN

# BORDER GUARD® BLACK



## DROP POINT

BOX ITEM: SWBG1 UPC: 28634702435

BOX ITEM: SWBG1S UPC: 28634702442

## TANTO

BOX ITEM: SWBG2T UPC: 28634702459

BOX ITEM: SWBG2TS UPC: 28634702466

## PRODUCT FEATURES

- Aluminum Handle
- Black Oxide High Carbon Stainless Steel Blade
- Dual Thumb Studs
- Liner Lock
- Strap Cutter
- Glass Breaker
- Pocket Clip
- Weight: 8.8oz



HANDLE LENGTH: 5.6 IN

BLADE LENGTH: 4.4 IN



OVERALL LENGTH: 10 IN



*Tanto Serrated Blade Option*



*Serrated Blade Option*

# BORDER GUARD® TANTO G10 HANDLE



BOX ITEM: SWBG6TS UPC: 28634706266

The Smith & Wesson® Border Guard® Liner Lock is made with a black tanto partially serrated blade with ambidextrous thumb studs. Its G-10 handle with lanyard hole, a glass breaking tool, strap cutter, and a pocket clip.

## PRODUCT FEATURES

- High Carbon Black Oxide S.S. Blade
- G-10 Handle
- Dual Thumb Studs
- Liner Lock
- Strap Cutter
- Glass Breaker
- Pocket Clip
- Weight: 9.2oz



HANDLE LENGTH: 5.9 IN



BLADE LENGTH: 4.2 IN

OVERALL LENGTH: 10.1 IN



# EXTREME OPS® TANTO SERRATED BLACK



BOX ITEM: CK5TBS UPC: 28634105649

BLISTER ITEM: CK5TBSCP UPC: 28634105656

## PRODUCT FEATURES

- Aluminum Handle
- Black Oxide High Carbon Stainless Steel Blade
- Dual Thumb Studs
- Liner Lock
- Pocket Clip
- Weight: 2.9oz



HANDLE LENGTH: 4.1 IN



# EXTREME OPS® DROP POINT LOCKBACK BLACK

BOX ITEM: CK105BKEU UPC: 28634703401



## PRODUCT FEATURES

- Aluminum Handle
- Black Oxide High Carbon Stainless Steel Blade
- Nail Groove
- Lockback
- Pocket Clip
- Weight: 4.6oz



HANDLE LENGTH: 4.6 IN



BLADE LENGTH: 3.4 IN



OVERALL LENGTH: 8 IN

# EXTREME OPS® DROP POINT TAN



## EXTREME OPS® DROP POINT TAN

SKU: CK105HDCP UPC: 28634705122

## EXTREME OPS® TANTO BLACK BLADE TAN

SKU: CK5TBSD UPC: 286340000616

### PRODUCT FEATURES

- Aluminum Handle
- Black Oxide High Carbon Stainless Steel Blade
- Dual Thumb Studs
- Liner Lock
- Pocket Clip
- Weight: 2.9oz



HANDLE LENGTH: 4.1 IN

EXTREME OPS® TANTO BLACK BLADE TAN



EXTREME OPS® DROP POINT TAN



# EXTREME OPS® TANTO G-10 BLACK

BOX ITEM: CK13TCP UPC: 28634705115



## PRODUCT FEATURES

- G-10 Handle
- High Carbon Stainless Steel Blade
- Dual Thumb Studs
- Liner Lock
- Pocket Clip
- Weight: 3.7oz



HANDLE LENGTH: 4.5 IN



OVERALL LENGTH: 7.8 IN

# EXTREME OPS® DROP POINT SILVER



BOX ITEM: CK105H UPC: 28634105663

BLISTER ITEM: CK105HCP UPC: 28634105687

## PRODUCT FEATURES

- Aluminum Handle
- High Carbon Stainless Steel Blade
- Dual Thumb Studs
- Pocket Clip
- Liner Lock
- Weight: 2.9oz



HANDLE LENGTH: 4.1 IN



OVERALL LENGTH: 7.3 IN



# EXTREME OPS® CLIP SERRATED BLACK/BLUE



BOX ITEM: CK111S UPC: 28634700462

## PRODUCT FEATURES

- Aluminum Handle
- Black Oxide High Carbon Stainless Steel Blade
- Dual Thumb Studs
- Liner Lock
- Pocket Clip
- Weight: 2.9oz



HANDLE LENGTH: 4.1 IN



# EXTREME OPS® CLIP POINT IRIDESCENT

BOX ITEM: CK113 UPC: 28634702831



## PRODUCT FEATURES

- Iridescent Handle
- Black Oxide High Carbon Stainless Steel Blade
- Dual Thumb Studs
- Liner Lock
- Pocket Clip
- Weight: 2.3oz



HANDLE LENGTH: 4.5 IN



BLADE LENGTH: 2.7 IN

OVERALL LENGTH: 6.4 IN

# EXTREME OPS® LOCKBACK NAIL GROOVE SILVER

BOX ITEM: CK6AEU UPC: 28634701865



## PRODUCT FEATURES

- Aluminum Handle
- High Carbon Stainless Steel Blade
- Nail Groove
- Lockback
- Pocket Clip
- Weight: 3.9oz



HANDLE LENGTH: 4.6 IN



BLADE LENGTH: 3.5 IN



OVERALL LENGTH: 8.1 IN

# EXTREME OPS® TANTO BLACK

BOX ITEM: CK10HBS UPC: 28634700806



## PRODUCT FEATURES

- Stainless Steel Handle
- Black Oxide High Carbon Stainless Steel Blade
- Dual Thumb Studs
- Frame Lock
- Pocket Clip
- Weight: 3.9oz



HANDLE LENGTH: 4.4 IN



BLADE LENGTH: 3.4 IN

OVERALL LENGTH: 7.8 IN

# EXTREME OPS® CLIP POINT SERRATED FOLDER



BOX ITEM: SWA24S UPC: 28634705436

BLISTER ITEM: SWA24SCP UPC: 28634704743

## PRODUCT FEATURES

- Aluminum Handle
- Black Oxide High Carbon Stainless Steel Blade
- Dual Thumb Studs
- Liner Lock
- Finger Flipper
- Pocket Clip
- Weight: 3.5oz



HANDLE LENGTH: 4 IN



BLADE LENGTH: 3.1 IN

OVERALL LENGTH: 7.1 IN



# EXTREME OPS® DROP POINT ALUMINUM HANDLE

BOX ITEM: SWA25 UPC: 28634705443



## PRODUCT FEATURES

- Aluminum Handle
- Black Oxide High Carbon Stainless Steel Blade
- Dual Thumb Studs
- Liner Lock
- Pocket Clip
- Weight: 3.2oz



HANDLE LENGTH: 4.5 IN



OVERALL LENGTH: 7.8 IN

# EXTREME OPS® TANTO SERRATED BLACK



BOX ITEM: SWFR2S UPC: 28634701605

BLISTER ITEM: SWFR2SCP UPC: 28634706174

## PRODUCT FEATURES

- Rubberized Aluminum Handle
- Black Oxide High Carbon Stainless Steel Blade
- Dual Thumb Studs
- Liner Lock
- Strap Cutter
- Glass Breaker
- Pocket Clip
- Weight: 4.4oz



HANDLE LENGTH: 4.7 IN



BLADE LENGTH: 3.3 IN



OVERALL LENGTH: 8 IN

# EXTREME OPS<sup>®</sup> DROP POINT SERRATED FOLDER

BLISTER ITEM: CK204CP UPC: 28634708642



## PRODUCT FEATURES

- Aluminum Handle
- Black Oxide High Carbon Stainless Steel Blade
- Dual Thumb Studs
- Liner Lock
- Finger Flipper
- Pocket Clip
- Weight: 4oz



HANDLE LENGTH: 4.7 IN



BLADE LENGTH: 3.1 IN

OVERALL LENGTH: 7.7 IN

# EXTREME OPS® KARAMBIT CAMO

BOX ITEM: CK32C UPC: 28634010394



## PRODUCT FEATURES

- Titanium Coated Stainless Steel Handle
- High Carbon Stainless Steel Blade
- Finger Hole
- Thumb Hole
- Frame Lock
- Pocket Clip
- Weight: 4.7oz



HANDLE LENGTH: 5 IN

BLADE LENGTH: 3 IN



OVERALL LENGTH: 8 IN

# EXTREME OPS® KARAMBIT HAWKBILL



BOX ITEM: CK33 UPC: 28634010486

## PRODUCT FEATURES

- G-10 Handle
- High Carbon Stainless Steel Blade
- Finger Hole
- Liner Lock
- Pocket Clip
- Weight: 6.8oz



HANDLE LENGTH: 4.7 IN

BLADE LENGTH: 3.1 IN



OVERALL LENGTH: 7.9 IN



# EXTREME OPS® TANTO STONEWASHED



BOX ITEM: CK404 UPC: 28634707409

CLAM PACK ITEM: CK404CP UPC: 28634707416

The Smith & Wesson® Extreme Ops® Frame Lock Partially Serrated Folding Knife is made with a stonewashed stainless-steel tanto blade. It features multiple ambidextrous thumb knobs and spine jimping. Its stonewashed skeleton handle also has a lanyard hole and pocket clip for easy access and storage.

## PRODUCT FEATURES

- Stainless Steel Handle
- Dual Thumb Studs
- Frame Lock
- Pocket Clip
- Weight: 2.3oz



HANDLE LENGTH: 3.58 IN

BLADE LENGTH: 2.65 IN



OVERALL LENGTH: 6.23 IN

# EXTREME OPS® DROP POINT BLACK

SKU: SWEX2S UPC: 28634700943



## PRODUCT FEATURES

- Stainless steel blade
- Aluminum Handle
- Pocket clip
- Ambidextrous thumb knobs
- Liner lock
- Jimping



BLADE LENGTH: 3.3 IN

OVERALL LENGTH: 7.8 IN

# EXECUTIVE GOLD

BOX ITEM: CK110GL UPC: 28634700431



## PRODUCT FEATURES

- Titanium Coated Stainless Steel Handle
- Titanium Coated High Carbon Stainless Steel Blade
- Dual Thumb Studs
- Frame Lock
- Pocket Clip
- Weight: 3.5oz



HANDLE LENGTH: 4 IN



BLADE LENGTH: 2.8 IN



OVERALL LENGTH: 6.8 IN

# OASIS® DROP POINT FOLDER



## OASIS® DROP POINT BLACK

BOX ITEM: SW423B UPC: 28634700783

## OASIS® DROP POINT STONEWASHED

CLAM PACK ITEM: SW421CP UPC: 28634707454

## OASIS® DROP POINT TITANIUM

CLAM PACK ITEM: SW423GCP UPC: 28634701407

## PRODUCT FEATURES

- Titanium Coated Stainless Steel Handle
- Titanium Coated High Carbon Stainless Steel Blade
- Dual Thumb Studs
- Liner Lock
- Pocket Clip
- Weight: 4.8oz



**EDGE RETENTION**

**7CR**



HANDLE LENGTH: 4.3 IN



DROP POINT TITANIUM



DROP POINT STONEWASHED

BLADE LENGTH: 3.2 IN



DROP POINT BLACK

OVERALL LENGTH: 7.5 IN



# DROP POINT FOLDER



BOX ITEM: CKLPB UPC: 28634001422

BLISTER ITEM: CKLPBCP UPC: 28634001439

## PRODUCT FEATURES

- Stainless Steel Handle
- High Carbon Stainless Steel Blade
- Dual Thumb Studs
- Frame Lock
- Weight: 1oz



HANDLE LENGTH: 3 IN

BLADE LENGTH: 2.3 IN



OVERALL LENGTH: 5.3 IN



# DROP POINT FOLDER - RAINBOW



BLISTER ITEM: CKLPRCP UPC: 28634990702

## PRODUCT FEATURES

- Stainless Steel Handle
- High Carbon Stainless Steel Blade
- Dual Thumb Studs
- Frame Lock
- Weight: 1oz



HANDLE LENGTH: 3 IN

BLADE LENGTH: 2.3 IN



OVERALL LENGTH: 5.3 IN

# 24/7<sup>®</sup> LOCKBACK BLACK

BOX ITEM: CK109 UPC: 28634700424



## PRODUCT FEATURES

- Aluminum Handle
- High Carbon Stainless Steel Blade
- Dual Thumb Studs
- Lockback
- Pocket Clip
- Weight: 2.8oz



HANDLE LENGTH: 4.4 IN



BLADE LENGTH: 3 IN

OVERALL LENGTH: 7.4 IN

# 24/7<sup>®</sup> TANTO FOLDER



BOX ITEM: 1147097 UPC: 661120107071

BLISTER ITEM: 1136219 UPC: 661120107064

The Smith & Wesson<sup>®</sup> 24/7<sup>®</sup> Folder is the ultimate knife for slim everyday carry. Featuring a unique textured handle and an ultra-smooth action, this knife boasts a full blade length with a super-slim profile making it a great carry knife. If you're looking for a slim EDC knife that won't take up a lot of pocket space, the 24/7<sup>®</sup> folder is the right knife for you. show less

## PRODUCT FEATURES

- G10 Handle Scales
- Liner Lock
- Ultra Glide<sup>®</sup> Bearing System
- Finger Flipper
- Tip-Up Pocket Clip

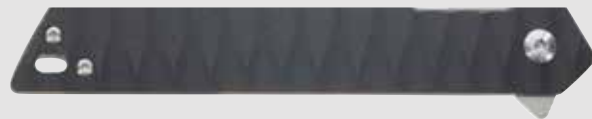

HANDLE LENGTH: 8.5 IN

BLADE LENGTH: 3.5 IN



OVERALL LENGTH: 12 IN

# WOOD HANDLE FOLDER



BOX ITEM: 1147091 UPC: 661120107033

BLISTER ITEM: 1136969 UPC: 661120104292

## PRODUCT FEATURES

- Frame Lock
- Stainless Steel Handle with Wood Inserts
- Tip-Down Pocket Clip
- Lanyard Hole
- Dual Thumb Studs



HANDLE LENGTH: 4.7 IN



OVERALL LENGTH: 8.5 IN

# DROP POINT SILVER SKELETONIZED



BOX ITEM: CK400 UPC: 28634707027

BLISTER ITEM: CK400CP UPC: 28634707164

## PRODUCT FEATURES

- Stainless Steel Handle
- High Carbon Stainless Steel Blade
- Dual Thumb Studs
- Frame Lock
- Pocket Clip
- Weight: 1.6oz



HANDLE LENGTH: 3.2 IN



BLADE LENGTH: 2.2 IN



OVERALL LENGTH: 5.4 IN

# DROP POINT SILVER SKELETONIZED, LARGE



BLISTER ITEM: CK400LCP UPC: 28634707195

BLISTER ITEM: CK400LTSCP UPC: 28634708055

## PRODUCT FEATURES

- Stainless Steel Handle
- High Carbon Stainless Steel Blade
- Dual Thumb Studs
- Frame Lock
- Pocket Clip
- Weight: 3.4oz



HANDLE LENGTH: 4.4 IN



*Tanto Serrated Blade Option*



# MULTI-TOOL FOLDING KNIFE

BLISTER ITEM: 1136970 UPC: 661120104308



## PRODUCT FEATURES

- Stainless Steel
- Frame Lock
- Three Hex Wrenches & Flathead Screwdriver
- Hydration Tool
- Tip-Up Pocket Clip
- Bottle Opener



HANDLE LENGTH: 3.5 IN



BLADE LENGTH: 2 IN

OVERALL LENGTH: 5.5 IN

# BIG BENJI



BLISTER ITEM: 1193144 UPC: 661120655459  
BOX ITEM: 1193145 UPC: 661120655466

Introducing the Big Benji - the ultimate multi-tool! This clever number has all of the same great features of the original Benji, but with a 2" longer blade. It's a knife, bottle opener and money clip - all in one package. The Ultra Glide® technology makes it easy to access, while the 8Cr high carbon stainless steel makes sure your knife remains sharp and reliable.

## PRODUCT FEATURES

- High carbon stainless steel
- Money clip for versatility
- Bottle opener for multi-tool capability
- Ultra Glide® technology for easier access
- Finger flipper for faster deployment
- Frame lock for easy one-handed close



HANDLE LENGTH: 4.25 IN

BLADE LENGTH: 3.5 IN



OVERALL LENGTH: 7.75 IN

# BENJI™ FOLDING KNIFE



BOX ITEM: 1122566 UPC: 661120081326

CLAM PACK ITEM: 1117230 UPC: 661120081302

Perfect for your discreet EDC, this knife packs big features in a small package. This all-in-one pocket knife, money clip, and bottle opener fits cleanly into the coin pocket of your favorite jeans, so you're always prepared.

## PRODUCT FEATURES

- G10 Handle
- Finger Flipper
- Frame Lock
- Ultra Glide®
- Tip Up Pocket Clip/Money Clip
- Bottle Opener



HANDLE LENGTH: 2.8 IN

BLADE LENGTH: 1.5 IN



OVERALL LENGTH: 4.3 IN



# FREIGHTER™ FOLDING KNIFE



BOX ITEM: 1122567 UPC: 661120081067

CLAM PACK ITEM: 1117232 UPC: 661120081104

The Freighter™ liner lock folding knife is the perfect addition to your collection. Constructed from a durable stainless steel frame and equipped with a belt clip and thumb stud, this sturdy pocket knife will hold up to any task and is perfect for everyday use.

## PRODUCT FEATURES

- Stainless Steel G10 Handle
- Dual Thumb Studs
- Liner Lock
- Tip Down Pocket Clip



HANDLE LENGTH: 4.5 IN



# SIDEBURN™ FOLDING KNIFE



BOX ITEM: 1122568 UPC: 661120081166

CLAM PACK ITEM: 1117235 UPC: 661120081173

Don't let the lightweight and sleek design fool you from thinking it's your ordinary everyday knife. This EDC has a Modified Wharncliffe blade giving it an edge above all the rest.

## PRODUCT FEATURES

- G10 Handle Scales
- Finger Flipper
- Birds Eye Opener
- Liner Lock
- Ultra Glide®
- Tip Up Pocket Clip



HANDLE LENGTH: 4 IN



BLADE LENGTH: 3 IN

OVERALL LENGTH: 7.3 IN

# STAVE™ FOLDING KNIFE



BOX ITEM: 1122569 UPC: 661120081333

BLISTER ITEM: 1117233 UPC: 661120081340

The Stave™ is your ideal knife for any task. The high-carbon steel blade has a curved belly that's perfect for cutting or chopping; while the stainless steel and G10 construction make this knife ultra-tough and great looking.

## PRODUCT FEATURES

- Stainless Steel G10 Handle
- Finger Flipper
- Liner Lock
- Ultra Glide®
- Tip Down Pocket Clip



HANDLE LENGTH: 4.5 IN



BLADE LENGTH: 3.3 IN



OVERALL LENGTH: 7.8 IN



# FREELANCER™ FOLDING KNIFE

BOX ITEM: 1122570 UPC: 661120081050

BLISTER ITEM: 1117234 UPC: 661120081098

This button lock clip point pocket knife is built for a smooth open. Break away from finger flippers and thumb studs for a smooth snap-open pocket knife that fits your everyday carry needs.

## PRODUCT FEATURES

- High Carbon Stainless Steel Blade
- G10 Handle Scales
- Button Lock/Unlock
- Tip Up Pocket Clip



HANDLE LENGTH: 4.5 IN

BLADE LENGTH: 3.5 IN



OVERALL LENGTH: 8 IN



# STONEWASH KEYCHAIN

BOX ITEM: 1100064 UPC: 661120076063

BLISTER ITEM: 1100065 UPC: 661120076070

Never be without your Smith & Wesson® Keychain Folding Knife. This knife comes with a G-10 stonewashed handle and a Ti-Nitride blade coating. This 3Cr13 steel blade is ideal for on-the-go. It weighs 2.4 ounces and has a blade length of 2.25" and includes a finger flipper, thumb stud, lanyard hole, and keychain for the avid adventurer.

## PRODUCT FEATURES

- Stainless Steel Blade
- Stonewash Coating
- Money Clip
- Nail Nick
- Frame Lock
- Thumb Stud
- Pocket Clip
- Bottle Opener
- Keychain Lanyard
- Weight: 2.4oz



HANDLE LENGTH: 3 IN

BLADE LENGTH: 2.25 IN



OVERALL LENGTH: 5.25 IN



# TANTO SILVER/BLACK



BOX ITEM: 1100066 UPC: 661120076087

BLISTER ITEM: 1100067 UPC: 661120076094

If you're on-the-go or need a handy tool, our S&W® Nylon Folding Knife is perfect for you. It's made with an 8Cr13MoV steel with a 2.75" blade length and weighs only 2.5 ounces. The glass-filled G-10 nylon handle comes with a finger flipper, liner lock and thumb stud.

## PRODUCT FEATURES

- Bead Blast Finished High Carbon S.S. Blade
- Glass Filled Nylon Handle With G-10 Texture
- Finger Flipper
- Pocket Clip
- Liner Lock
- Thumb Stud
- Weight: 2.5oz



HANDLE LENGTH: 3.25 IN



BLADE LENGTH: 2.75 IN



OVERALL LENGTH: 6 IN

# CLIP FOLDER WITH KEYCHAIN



BLISTER ITEM: 1100061 UPC: 661120076032

## PRODUCT FEATURES

- Black Oxide Coated High Carbon S.S. Blade
- Polymer Handle
- Included Keychain Bottle Opener
- Pocket Clip
- Liner Lock
- Thumb Stud
- Weight: 3.7oz



HANDLE LENGTH: 4.5 IN



BLADE LENGTH: 3.25 IN

OVERALL LENGTH: 7.65 IN

# CLIP FOLDER G10

BOX ITEM: 1100062 UPC: 661120076049

BLISTER ITEM: 1100063 UPC: 661120076056

The Smith & Wesson® Clip Fold Knife has a G-10 Aluminum Handle and is excellent for outdoor survival, camping, and EDC. With a 3.25" blade length and a weight of 4.7 ounces, this durable knife is dependable in nearly all situations. It has a spring-assisted opening, thumb stud, and a lanyard hole, as well as a convenient pocket clip for quick access. It is made of 8Cr13MoV black oxide coated high carbon stainless steel.

## PRODUCT FEATURES

- G10 Handle
- Finger Flipper
- Liner Lock
- Pocket Clip
- Thumb Stud
- Lanyard Hole
- Weight: 4.7oz



HANDLE LENGTH: 4.5 IN



BLADE LENGTH: 3.25 IN

OVERALL LENGTH: 7.75 IN



# S.W.A.T.® II CLIP POINT FOLDING KNIFE



BOX ITEM: 1100058 UPC: 661120076001

BLISTER ITEM: 1100059 UPC: 661120076018

S&W® SWAT® II will be your toughest knife yet. It has a 8Cr13MoV steel black serrated blade and a black/OD Green rubberized aluminum handle. At 5.2 ounces and a blade length of 3.5" it's the perfect EDC for the outdoor enthusiast, the hunter or ultimate survival. Included is a thumb stud, lanyard hole and a pocket clip.

## PRODUCT FEATURES

- Black Oxide Coated High Carbon S.S. Blade
- Rubberized Aluminum Handle
- Thumb Stud
- Liner Lock
- Pocket Clip
- Lanyard Hole
- Weight: 5.2oz



HANDLE LENGTH: 5 IN

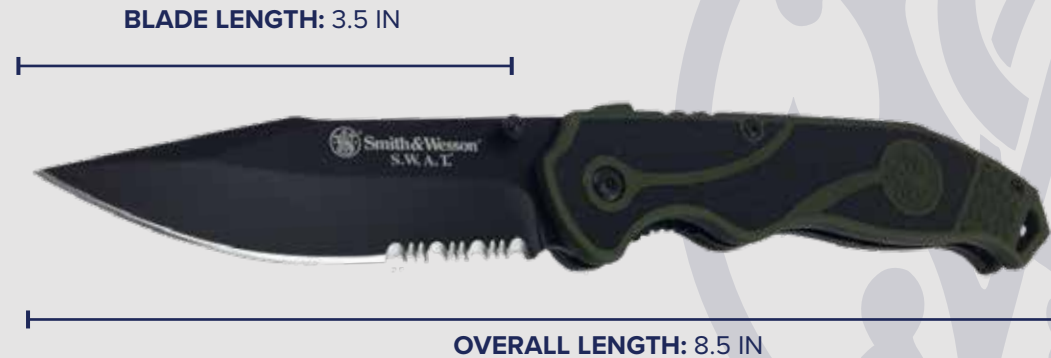



# 24/7<sup>®</sup> FOLDING CLEAVER



BLISTER ITEM: 1193141 UPC: 661120655435  
BOX ITEM: 1193142 UPC: 661120655442

This folding cleaver is perfect for those who want a versatile cutting tool that they can use in a variety of ways. With a chisel blade that is ideal for cutting through tough materials, a spring assist design that makes it easy to open and close one-handed, and a liner lock that keeps it safe and secure, this cleaver is a must-have for anyone who wants to take EDC to the next level.

## PRODUCT FEATURES

- Chisel blade for versatile use
- Assisted opening for quick and easy access
- Liner lock for easy one-handed close



HANDLE LENGTH: 4.5 IN

BLADE LENGTH: 3.25 IN



OVERALL LENGTH: 7.75 IN

# DRIVE™



CLAM PACK ITEM: 1117229 UPC: 661120081135

Always be prepared with the Smith & Wesson® Drive™ Folding Knife. The high-carbon blade is perfect for all your daily cutting tasks. Its keychain accessibility and integral bottle opener make sure you're always hydrated wherever you are.

## PRODUCT FEATURES

- Stainless Steel Blade
- Stonewashed Aluminum Handle
- Finger Flipper
- Frame Lock
- Ultra Glide®
- Bottle Opener



HANDLE LENGTH: 2 IN

BLADE LENGTH: 1.3 IN



OVERALL LENGTH: 3.3 IN



**Smith & Wesson®**

**ASSISTED OPENING**

# DROP POINT BLACK/FDE HANDLE



BLISTER ITEM: 1084303 UPC: 661120413288

## PRODUCT FEATURES

- Black Oxide Coated High Carbon S.S. Blade
- Rubberized Aluminum Handle
- Assisted Opening
- Dual Thumb Studs
- Liner Lock
- Pocket Clip
- Weight: 4.8oz



HANDLE LENGTH: 4.5 IN



BLADE LENGTH: 3.5 IN

OVERALL LENGTH: 8 IN

# S.A. RED ACCENT



BOX ITEM: 1100038 UPC: 661120075981

BLISTER ITEM: 1100039 UPC: 661120075998

## PRODUCT FEATURES

- Black Oxide Coated High Carbon S.S. Blade
- Rubberized Aluminum Handle
- Assisted Opening
- Thumb Stud
- Liner Lock
- Pocket Clip
- Tungsten Glass Breaker
- Seat Belt Cutter
- Weight: 5oz



HANDLE LENGTH: 4.75 IN



BLADE LENGTH: 3.25 IN

OVERALL LENGTH: 8 IN

# S.A. OD GREEN



BOX ITEM: 1100036 UPC: 661120075967

BLISTER ITEM: 1100037 UPC: 661120075974

## PRODUCT FEATURES

- Black Oxide Coated High Carbon S.S. Blade
- Rubberized Aluminum Handle
- Assisted Opening
- Thumb Stud
- Liner Lock
- Pocket Clip
- Weight: 4.5oz



HANDLE LENGTH: 4.5 IN



BLADE LENGTH: 3.25 IN

OVERALL LENGTH: 7.75 IN



# 1ST RESPONSE® M.A.G.I.C.®



## BLUNT TIP

BOX ITEM: SW911B UPC: 28634702176

## TANTO

BOX ITEM: SW911N UPC: 28634702077

The Smith & Wesson® has a 3rd Generation 1st Response® M.A.G.I.C.® Assisted Opening Liner Lock Folding Knife & Rescue Tool. It's made with a black stainless-steel double hollow ground serrated recurve tanto blade. It features dual thumb studs and jimping, textured, and a designed black nylon fiber handle with a safety lock, spring-loaded glass breaker, and a pocket clip.

## PRODUCT FEATURES

- Stainless Steel Blade
- Glass Filled Nylon Handle
- Thumb Jimping
- Dual Thumb Studs
- Safety Lock
- Spring Loaded Glass Breaker
- Pocket Clip
- Weight: 4.9oz



BLADE LENGTH: 3.4 IN



HANDLE LENGTH: 4.8 IN



OVERALL LENGTH: 8.2 IN



# SPEC OPS™ CARBON

BLISTER ITEM: 1160827 UPC: 661120265412  
BOX ITEM: 1179962 UPC: 661120265429



## PRODUCT FEATURES

- High Carbon Stainless Steel Blade
- Titanium Nitride Coated Blade
- Spring Assisted Blade
- Finger Flipper
- Liner Lock
- Tip Down Pocket Clip



HANDLE LENGTH: 4.5 IN



BLADE LENGTH: 3.5 IN



OVERALL LENGTH: 8 IN

# SPECIAL OPS® TANTO

BOX ITEM: SPECM UPC: 28634701322



## PRODUCT FEATURES

- 4034 Black Oxide S.S. Blade
- Aluminum Handle
- M.A.G.I.C.® Assisted Opening
- Finger Actuator
- Dual Thumb Knobs
- Liner Lock
- Safety Lock
- Pocket Clip



- Blade Length: 3.1" (7.9 cm)
- Overall Length: 7.4" (18.8 cm)
- Weight: 4.1oz



HANDLE LENGTH: 4.2 IN



BLADE LENGTH: 3.2 IN



OVERALL LENGTH: 7.4 IN

# EXECUTIVE BARLOW



BOX ITEM: 1147094 UPC: 661120107057

BLISTER ITEM: 1136223 UPC: 661120107040

## PRODUCT FEATURES

- G10 Handle Scales
- Liner Lock
- Spring Assisted Opening
- Finger Flipper
- Tip-Down Pocket Clip



**ASSISTED  
OPENING**



**EDGE RETENTION**

**BCR**



**HANDLE LENGTH: 3.5 IN**



**BLADE LENGTH: 2.75 IN**



**OVERALL LENGTH: 6.25 IN**

# EXECUTIVE ROSEWOOD BARLOW



BLISTER ITEM: 1160818 UPC: 661120265399  
BOX ITEM: 1179950 UPC: 661120265405

## PRODUCT FEATURES

- Rosewood Scales
- Liner Lock
- Spring Assisted Opening
- Finger Flipper
- Tip-Down Pocket Clip



HANDLE LENGTH: 3.5 IN



BLADE LENGTH: 2.75 IN

OVERALL LENGTH: 6.25 IN

# VELOCITE™ ASSISTED OPENING



BOX ITEM: 1122573 UPC: 661120081036

BLISTER ITEM: 1117237 UPC: 661120081081

This is one of our lightest EDC pocket knives. This clip point pocket knife is built with a heavily textured grip and a spring-assisted opening mechanism for a smooth open every time. Solid, sturdy, and an extremely light composition make this knife the perfect addition for an on-the-go carry.

## PRODUCT FEATURES

- Textured Polymer Handle
- Finger Flipper
- Liner Lock
- Tip Down Pocket Clip
- Spring Assisted Opening



HANDLE LENGTH: 4.5 IN

BLADE LENGTH: 3.4 IN



OVERALL LENGTH: 7.9 IN



# CLEFT™ ASSISTED OPENING



BOX ITEM: 1122572 UPC: 661120081043

BLISTER ITEM: 1117238 UPC: 661120081074

A hefty clip point folding knife built tough enough to handle your biggest jobs, this EDC packs a sturdy blade for heavy duty work in a compact package. Complete with a belt clip and thumb stud, this boldly distinguished and ruggedly handsome pocket knife is built to handle your toughest tasks with ease.

## PRODUCT FEATURES

- Stainless Steel G10 Handle Scales
- Dual Thumb Studs
- Liner Lock
- Tip Up Pocket Clip
- Spring Assisted Opening



HANDLE LENGTH: 4.5 IN

BLADE LENGTH: 3.4 IN



OVERALL LENGTH: 7.9 IN



# BLACK OPS® RECURVE SPRING ASSIST



BOX ITEM: 1147098 UPC: 661120107095

BLISTER ITEM: 1136220 UPC: 661120107088

## PRODUCT FEATURES

- G10 Handle Scales
- Liner Lock
- Spring Assisted Opening
- Finger Flipper
- Reversible Pocket Clip
- Weight: 5oz



HANDLE LENGTH: 4.5 IN



BLADE LENGTH: 3.5 IN

OVERALL LENGTH: 8 IN

# BLACK OPS<sup>®</sup> SILVER HANDLE



## DROP POINT BLADE SILVER HANDLE

CLAM ITEM: SWBLOP3CP UPC: 28634704316

## DROP POINT SERRATED BLADE SILVER HANDLE

BOX ITEM: SWBLOP3S UPC: 28634703531

## FOLDING DROP POINT SERRATED SILVER

CLAM ITEM: SWBLOP3SMSCP UPC: 28634705702

## TANTO POINT BLADE SILVER HANDLE

BOX ITEM: SWBLOP3T UPC: 28634703548

## TANTO POINT SERRATED BLADE SILVER HANDLE

CLAM ITEM: SWBLOP3TSCP UPC: 28634704446

## PRODUCT FEATURES

- Stainless Steel Blade
- Aluminum Handle
- M.A.G.I.C.<sup>®</sup> Assisted Opening
- Finger Actuator
- Dual Thumb Knobs
- Liner Lock
- Safety Lock
- Pocket Clip
- Weight 4.8oz



*Serrated Blade Option*



*Tanto Blade Option*



*Tanto Serrated Blade Option*



HANDLE LENGTH: 4.3 IN



BLADE LENGTH: 3.4 IN

OVERALL LENGTH: 7.7 IN

# BLACK OPS<sup>®</sup> TANTO SAND COLOR



BOX ITEM: SWBLOP3TD UPC: 28634706372

## PRODUCT FEATURES

- Stainless Steel Blade
- Aluminum Handle
- M.A.G.I.C.<sup>®</sup> Assisted Opening
- Finger Actuator
- Dual Thumb Knobs
- Liner Lock
- Safety Lock
- Pocket Clip
- Weight 4.8oz



# BLACK OPS® TANTO BLUE/BLACK



## TANTO POINT BLADE BLUE/BLACK HANDLE

BOX ITEM: SWBLOP3TBL UPC: 28634704040

## TANTO POINT SERRATED BLADE BLUE/BLACK HANDLE

BOX ITEM: SWBLOP3TBLS UPC: 28634704057

## PRODUCT FEATURES

- Stainless Steel Blade
- Aluminum Handle
- M.A.G.I.C.® Assisted Opening
- Finger Actuator
- Dual Thumb Knobs
- Liner Lock
- Safety Lock
- Pocket Clip
- Weight 4.8oz

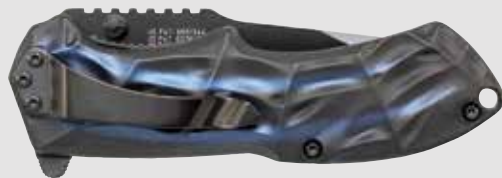

HANDLE LENGTH: 4.3 IN



Serrated Blade Option



BLADE LENGTH: 3.4 IN

OVERALL LENGTH: 7.7 IN

# BLACK OPS<sup>®</sup> DROP POINT - PINK



BOX ITEM: SWBLOP3SMP UPC: 028634705993

BLISTER ITEM: SWBLOP3SMPCP UPC: 028634705795

## PRODUCT FEATURES

- 4034 Black Oxide S.S. Blade
- Aluminum Handle
- M.A.G.I.C.<sup>®</sup> Assisted Opening
- Finger Actuator
- Dual Thumb Knobs
- Liner Lock
- Safety Lock
- Pocket Clip
- Weight: 2.6 oz.



BLADE LENGTH: 2.5 IN





# BLACK OPS<sup>®</sup> DROP POINT BLADE



CLAM ITEM: SWBLOP2SMBSCP UPC: 028634705665

## PRODUCT FEATURES

- 4034 Black Oxide S.S. Blade
- Aluminum Handle
- M.A.G.I.C.<sup>®</sup> Assisted Opening
- Finger Actuator
- Dual Thumb Knobs
- Liner Lock
- Safety Lock
- Pocket Clip
- Weight: 2.3oz



HANDLE LENGTH: 3.3 IN



BLADE LENGTH: 2.6 IN

OVERALL LENGTH: 5.9 IN

# S.W.A.T.® DROP POINT



## DROP POINT BLADE BLACK HANDLE

BOX ITEM: SWATMB UPC: 28634700165

## DROP POINT BLADE BLACK HANDLE

CLAM PACK ITEM: SWATMBCP UPC: 28634703722

## DROP POINT SERRATED BLADE BLACK HANDLE

BOX ITEM: SWATMBS UPC: 28634700172

## PRODUCT FEATURES

- 4034 Black Oxide S.S. Blade
- Aluminum Handle
- M.A.G.I.C.® Assisted Opening
- Finger Actuator
- Liner Lock
- Safety Lock
- Pocket Clip
- Weight: 3.9oz



HANDLE LENGTH: 4.3 IN

BLADE LENGTH: 3.2 IN



OVERALL LENGTH: 7.5 IN



Serrated Blade Option

# S.W.A.T.® DROP POINT BLACK HANDLE



## DROP POINT BLADE BLACK HANDLE

BOX ITEM: SWATLB UPC: 28634700714

## DROP POINT SERRATED BLADE BLACK HANDLE

BOX ITEM: SWATLBS UPC: 28634700721

## PRODUCT FEATURES

- 4034 Black Oxide S.S. Blade
- Aluminum Handle
- M.A.G.I.C.® Assisted Opening
- Finger Actuator
- Dual Thumb Knobs
- Liner Lock
- Safety Lock
- Pocket Clip
- Weight: 5.8 oz.



HANDLE LENGTH: 4.8 IN



BLADE LENGTH: 3.7 IN

OVERALL LENGTH: 8.5 IN



Serrated Blade Option

# OUT THE FRONT



## DAGGER POINT BLADE GREY HANDLE

BOX ITEM: SWOTF9B UPC: 28634709762

## DAGGER POINT SERRATED BLADE GREY HANDLE

BOX ITEM: SWOTF9BS UPC: 28634709779

## TANTO POINT BLADE GREY HANDLE

BOX ITEM: SWOTF9TB UPC: 28634709786

## TANTO POINT SERRATED BLADE GREY HANDLE

BOX ITEM: SWOTF9TBS UPC: 28634709793

## PRODUCT FEATURES

- AUS-8 Steel Blade
- Aluminum Handle
- Blade Release
- Safety Lock
- Glass Breaker
- Blade Slider
- Pocket Clip
- Weight: 6oz



HANDLE LENGTH: 5.5 IN

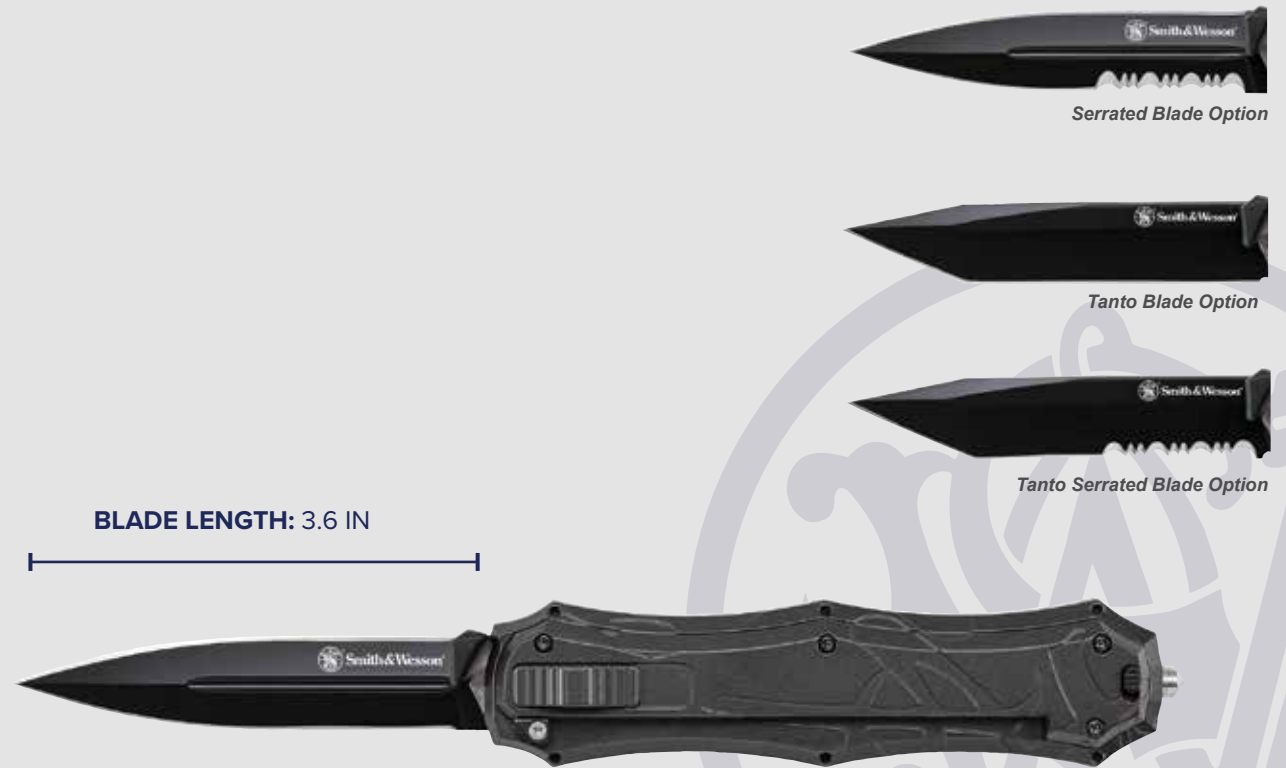

BLADE LENGTH: 3.6 IN

OVERALL LENGTH: 8.8 IN



Smith & Wesson®

**FIXED KNIVES**

# 24/7<sup>®</sup> TANTO FIXED

BOX ITEM: 1147099 UPC: 661120107071

BLISTER ITEM: 1136218 UPC: 661120107132



The 24/7<sup>®</sup> Fixed is the folder's big brother, great for heavy duty jobs. The grooved handle is a comfortable hit and is a true full tang, with steel is visible on all sides. The blade itself is a beefy tanto with a deep bevel that gives the tanto a sleek look. Despite this, the blade is still hefty enough for your tough jobs weighing in at just over 6 ounces. The plastic handle features two different sized holes for multiple lashing options and a clip for belt or boot carry.

## PRODUCT FEATURES

- High Carbon Stainless Steel Blade
- G10 Handle Scales
- Full Tang
- Sheath Included
- Lanyard Hole



BLADE LENGTH: 4 IN



OVERALL LENGTH: 8.5 IN



# 3.5" H.R.T.® BOOT KNIFE



## 7.5" H.R.T.® DUAL EDGE BOOT

BOX ITEM: SWHRT3 UPC: 28634892303

## 7.5" H.R.T.® BLACK FALSE EDGE BOOT

BOX ITEM: SWHRT3BF UPC: 28634892310

The Smith & Wesson® H.R.T.® Full Tang Fixed Blade Knife is made out of a high carbon stainless-steel spear point blade. The blade is 7.5" and comes with a black TPR handle with lanyard hole and black nylon/fiberglass belt/boot sheath for lashing to pack or gear.

## PRODUCT FEATURES

- Full Tang
- High Carbon Stainless Steel
- TPR Handle
- Lanyard Hole
- Nylon/Fiberglass Belt/Boot Sheath
- Weight 4.6oz





# 4.75" H.R.T.® BOOT KNIFE



## H.R.T.® 9" DUAL EDGE BOOT KNIFE

BOX ITEM: SWHRT9B UPC: 28634939206

CLAM PACK ITEM: SWHRT9BCP UPC: 28634703456

## H.R.T.® 9" FALSE EDGE BOOT KNIFE

BOX ITEM: SWHRT9BF UPC: 28634705450

BLISTER ITEM: SWHRT9BFCP UPC: 28634705047

The Smith & Wesson® H.R.T.® Full Tang Fixed Blade Knife is made out of a black high carbon stainless-steel dual-edged spear point blade with blood grooves. Its TPE rubber wrapped handle comes with lanyard hole and black leather belt/boot sheath

## PRODUCT FEATURES

- High Carbon Stainless Steel
- Full Tang
- Lanyard Hole
- TPE Handle
- Leather Sheath
- Weight: 7.7oz



# 2.75" H.R.T.® FDE FALSE EDGE BOOT KNIFE



BOX ITEM: 1100072 UPC: 661120076124

BLISTER ITEM: 1100073 UPC: 661120076131

The Smith & Wesson® FDE Boot Knife is ideal for carrying on you when you're on-the-go. It has a single edge with finger guards and a rubberized polymer handle for a quick draw and maximized control. Weighing at 1.6 ounces and a blade length of 2.75" it's perfect for concealed carry. Included is a plastic sheath.

## PRODUCT FEATURES

- Black Oxide Coated High Carbon S.S. Blade
- Rubberized Handle
- Single Edge
- Finger Guards
- Hard Polymer Sheath Included
- Weight: 1.6oz



# 2" H.R.T.® BOOT/NECK KNIFE

BLISTER ITEM: 1160815 UPC: 661120999829  
BOX ITEM: 1182571 UPC: 661120999959



## PRODUCT FEATURES

- High Carbon Stainless Steel
- Rubberized Handle
- Injected Nylon Sheath
- Single Edge
- Finger Guards



BLADE LENGTH: 2 IN



OVERALL LENGTH: 5 IN

# 4" H.R.T.® BOOT KNIFE

BLISTER ITEM: 1160816 UPC: 661120999836  
BOX ITEM: 1182572 UPC: 661120999973



## PRODUCT FEATURES

- High Carbon Stainless Steel
- Rubberized Handle
- Injected Nylon Sheath
- Single Edge
- Finger Guards



# 5.5" H.R.T.<sup>®</sup> BOOT KNIFE

BLISTER ITEM: 1183086 UPC: 661120651222  
BOX ITEM: 1182573 UPC: 661120999980



## PRODUCT FEATURES

- High Carbon Stainless Steel
- Rubberized Handle
- Injected Nylon Sheath
- Single Edge
- Finger Guards

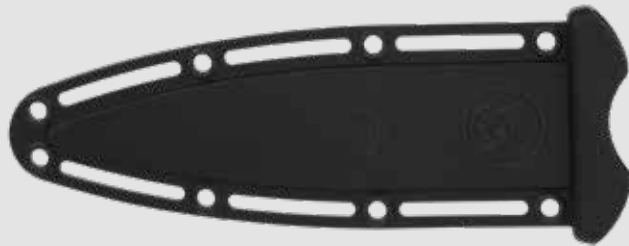

# DUAL EDGE BOOT KNIFE, STONE WASHED



BOX ITEM: SWF606 UPC: 028634709113

The Smith & Wesson® Full Tang Boot Knife Fixed Blade Knife is made with a stonewashed high carbon stainless-steel dual-edged spear point blades with dual finger choils. Its black TPE handle slabs come with a lanyard hole, pommel jimping, and premium black leather boot/belt sheath with security snap.

## PRODUCT FEATURES

- Stonewash High Carbon S.S. Blade
- G10 TPE Handle
- Full Tang
- Leather Boot/Belt Sheath
- Lanyard Hole
- Pommel Jimping
- Weight: 5.8oz



NO SHIP CA, NY, MA

# SPECIAL OPS® TANTO FIXED BLADE



## TANTO BLADE BLACK HANDLE

BOX ITEM: SW7 UPC: 28634706075

## TANTO SERRATED BLADE BLACK HANDLE

BOX ITEM: SW7S UPC: 28634706099

## PRODUCT FEATURES

- TPE Handle
- Ambidextrous Sheath
- Lanyard Hole
- Full Tang
- Stainless Steel Pommel





# TANTO NECK KNIFE PARACORD WRAPPED



BOX ITEM: SW910TAM UPC: 28634707737

BLISTER ITEM: SW910TAMCP UPC: 28634707744

Smith & Wesson® Tanto Neck Knife is made from stainless-steel and features a tanto point blade. It comes with a sheath and chain, so you can carry it securely around your neck.

## PRODUCT FEATURES

- High Carbon S.S. Blade
- Full Tang w/550 Paracord Wrapped Handle
- Nylon Fiber Neck Sheath w/Breakaway Chain
- Weight: 1.8oz



HANDLE LENGTH: X IN



BLADE LENGTH: 2.8 IN

OVERALL LENGTH: 5.9 IN

# SEARCH & RESCUE®



## CLIP POINT BLADE BLACK HANDLE

BOX ITEM: CKSUR1 UPC: 28634892655

## BOWIE POINT BLADE BLACK HANDLE

BOX ITEM: CKSUR2CP UPC: 28634892693

## TANTO POINT BLADE BLACK HANDLE

BOX ITEM: CKSURT UPC: 28634892648

## PRODUCT FEATURES

- High Carbon Black Oxide S.S. Blade
- Rubberized Aluminum Handle
- Ballistic Sheath w/Sharpening Stone
- Weight: 7.4oz



BOWIE POINT BLADE



TANTO POINT BLADE



BLADE LENGTH: 6 IN



OVERALL LENGTH: 10.5 IN



# SEARCH & RESCUE® DROP POINT



BOX ITEM: 1100070 UPC: 661120076100

BLISTER ITEM: 1100071 UPC: 661120076117

Smith & Wesson® Search & Rescue® Fixed Blade knife is ready for whatever comes its way. It features a 8Cr13MoV high carbon stainless-steel blade and rubberized aluminum handle for a firm grip. The blade is also powder-coated and 6", so you can make large cuts. This fixed blade knife includes a ballistic sheath and a sharpening stone that keeps the knife prepared for any situation.

## PRODUCT FEATURES

- Black Oxide Coated High Carbon S.S. Blade
- Rubberized Handle
- Partial Serration
- Blood Groove
- Tungsten Glass Breaker
- Sharpener Included
- Sheath Included
- Weight: 13.6oz

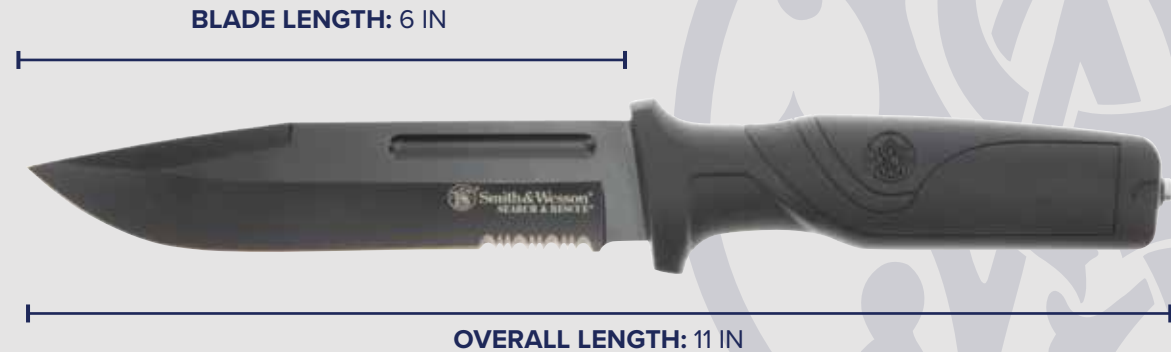

# SPECIAL OPS® M-9 BAYONET

BOX ITEM: SW3B UPC: 28634700592

CLAM PACK ITEM: SW3BCP UPC: 28634706631

Our Smith & Wesson® Special Ops® M-9 Bayonet comes fully loaded with a black powder coated spear point blade and a textured nylon handle. The edge has a notched spine and large blood grooves and deep saw cuts in the spine. Included is a black scabbard with a large storage pouch, a sharpening stone, and wire cutters.

## PRODUCT FEATURES

- 420J2 Black Oxide Steel Blade
- Nylon Fiber Handle
- Scabbard w/Sharpening Stone
- Spear Point With Notched Spine
- M9 Bayonet Mount fits onto AR15/M16 Mil-Spec Rifles
- Weight: 14.6oz



# M-9 BAYONET OD

BOX ITEM: SW3G UPC: 28634700608



## PRODUCT FEATURES

- 420J2 S.S. Blade
- Nylon Fiber Handle
- Scabbard w/Sharpening Stone
- Spear Point With Notched Spine
- M9 Bayonet Mount fits onto AR15/M16 Mil-Spec Rifles
- Weight: 14.6oz



# SPEAR



BOX ITEM: SW8 UPC: 28634706648

The Smith & Wesson® Spear Fixed Blade has a black stainless-steel false edged spear point blade. It has a black nylon filled glass fiber handle that screws off for a spear attachment to common broom handle. Included is a black polyester belt sheath.

## PRODUCT FEATURES

- Stainless Steel Black Oxide Blade
- Glass Filled Nylon Handle
- Screws onto Common Broom Handle Thread
- Nylon Belt Sheath
- Weight: 8.5oz



# HATCHET/KNIFE COMBO

BOX ITEM: CH629 UPC: 28634381029



## PRODUCT FEATURES

- Blade Type - 3Cr13 S.S.
- Handle Material - Rubberized Steel
- Nylon Sheath



9.5"



10.7"



# H.R.T.<sup>®</sup> CLEAVER NECK KNIFE

BLISTER ITEM: 1193152 UPC: 661120655527  
BOX ITEM: 1193153 UPC: 661120655534

This H.R.T.<sup>®</sup> Cleaver Neck Knife is the perfect tool for everyday carry. Its G10 handle provides added durability, the 8Cr steel blade provides better edge retention, the titanium nitride blade coating protects it from corrosion, and the breakaway neck cord ensures safety. The molded nylon sheath makes it easy to carry and easier to deploy. Whether you're looking for a lightweight EDC option or something with a little more stealth, this H.R.T.<sup>®</sup> Neck Knife is a great choice.

## PRODUCT FEATURES

- G10 handle for added durability
- Titanium nitride blade coating for corrosion resistance
- Breakaway neck cord for safety
- Molded nylon sheath for convenient carry



# H.R.T.® KARAMBIT NECK KNIFE



BLISTER ITEM: 1193154 UPC: 661120655541  
BOX ITEM: 1193155 UPC: 661120655558

This H.R.T.® Karambit Neck Knife is the perfect tool for everyday carry. Its G10 handle provides added durability, the 8Cr steel blade provides better edge retention, the titanium nitride blade coating protects it from corrosion, and the breakaway neck cord ensures safety. The molded nylon sheath makes it easy to carry and easier to deploy. Whether you're looking for a lightweight EDC option or something with a little more stealth, this H.R.T.® Neck Knife is a great choice.

## PRODUCT FEATURES

- G10 handle for added durability
- Titanium nitride blade coating for corrosion resistance
- Breakaway neck cord for safety
- Molded nylon sheath for convenient carry



BLADE LENGTH: 2 IN



OVERALL LENGTH: 5.2 IN



# H.R.T.® SPEAR POINT NECK KNIFE



BLISTER ITEM: 1193156 UPC: 661120655565  
BOX ITEM: 1193157 UPC: 661120655572

This H.R.T.® Spear Point Neck Knife is the perfect tool for everyday carry. Its G10 handle provides added durability, the 8Cr steel blade provides better edge retention, the black titanium nitride coating protects it from corrosion, and the breakaway neck cord ensures safety. The molded nylon sheath makes it easy to carry and easier to deploy. Whether you're looking for a lightweight EDC option or something with a little more stealth, this H.R.T.® Neck Knife is a great choice.

## PRODUCT FEATURES

- G10 handle for added durability
- Titanium nitride blade coating for corrosion resistance
- Breakaway neck cord for safety
- Molded nylon sheath for convenient carry



BLADE LENGTH: 2 IN



OVERALL LENGTH: 5.5 IN



# OUTBACK KUKRI FIXED BLADE

BLISTER ITEM: SWBH UPC: 028634990818

This full tang kukri is ready for any adventure you take it on. It's forward weighted blade shape is perfect for chopping and with the rubberized handle you always have a good grip on it.

## PRODUCT FEATURES

- Full Tang
- Nylon Belt Sheath with Shoulder Strap







Smith & Wesson®

**THROWING PRODUCTS**



# BULLSEYE® ULTIMATE THROWING COMBO

BOX ITEM: 1139486 UPC: 661120107125



The Ultimate Throwing Pack has a wide variety of throwing implements for you to work your board over. Featuring our iconic throwing knives and axes, the pack also includes the newest addition to the S&W® throwing family: our all-new cleavers. All made out of durable stainless steel to prevent knicks and sharpened for good sticks, master your short-range game with the Ultimate Throwing Pack.

## PRODUCT FEATURES

- Stainless Steel
- 3 Pack Cleavers, Axes, & Knives
- 4 Pack Cards
- Sheaths Included



# BULLSEYE® THROWING CLEAVER - 3 PACK



BLISTER ITEM: 1136221 UPC: 661120107118

We're taking throwing knives to the next level: with cleavers. These well-balanced stainless steel cleavers are weighted for the ideal turn so you can make sure your throws hit consistently. Each of the throwing cleavers also features a bottle opener on the end of the handle, just make sure you throw responsibly.

## PRODUCT FEATURES

- Stainless Steel
- 3 pack
- Bottle Opener
- Nylon Sheath



OVERALL LENGTH: 10 IN



# BULLSEYE® THROWING CARDS - 4 PACK

BLISTER ITEM: 1136222 UPC: 661120107101

The Bullseye® throwing cards from Smith & Wesson® are a great addition to your throwing arsenal. Well balanced and weighted for throwing with pristine edges to make sure your throws stick, you'll have a blast flinging these cards on your homemade boards or at your local throwing range.

## PRODUCT FEATURES

- Stainless Steel
- Textured Back for Enhanced Grip
- 4 Pack
- Laser Etched
- Nylon Sheath



# BULLSEYE® LARGE THROWING AXE

BLISTER ITEM: 1160822 UPC: 661120265368



## PRODUCT FEATURES

- Balanced design with three beveled edges making it easier to find the target
- Bottle opener in handle offers multi-tool capability
- Nylon sheath included for convenient storage and travel
- Stainless steel construction for extreme durability



OVERALL LENGTH: 20 IN

# BULLSEYE® THROWING AXES

CLAM ITEM: 1117231 UPC: 661120081128

Three axes are better than one. Enjoy a fun night axe throwing with a built-in bottle opener and premium steel construction. With perfectly balanced frames and a sharpened edge on three sides, you're bound to hit the bullseye every time.

## PRODUCT FEATURES

- Stainless Steel Construction
- Comes in a Set of 3
- Integrated Bottle Opener
- Nylon Sheath



OVERALL LENGTH: 10.3 IN



3 Pack

# BULLSEYE® THROWING COMBO



BOX ITEM: 1122228 UPC: 661120081111

Three super sharp axes combined with three precision throwing knives make the perfect throwing combo.

## PRODUCT FEATURES

- Stainless Steel Construction
- 3 Pack Axes
- 3 Pack Knives
- Integrated Bottle Opener on Axes
- Nylon Sheath for Each Set
- Overall Length Axes 10.3"
- Overall Length Knives 8"

3 Pack



3 Pack



# BULLSEYE® THROWING KNIVES - 3 PACK



BLISTER ITEM: SWTK8CP UPC: 28634706280

## PRODUCT FEATURES

- 2Cr13 Black Oxide S.S.
- Comes in a Set of 3
- Nylon Belt Sheath
- Individual Weight 4.1oz



OVERALL LENGTH: 8 IN



# BULLSEYE® THROWING KNIVES - 3 PACK



BLISTER ITEM: SWTK10CP UPC: 28634706297

## PRODUCT FEATURES

- (3) - 10" Throwing Knives
- Nylon Belt Sheath
- Individual Weight 7oz



OVERALL LENGTH: 10 IN



# BULLSEYE® THROWING KNIVES - 6 PACK



BLISTER ITEM: SWTK8CP UPC: 28634706280

Smith & Wesson® 6 pack of 8" throwing knives are made out of stainless-steel dual edged spear point blades. Included is a black polyester belt sheath.

## PRODUCT FEATURES

- 2Cr13 Stainless Steel
- (6) - 8" Throwing Knives
- Nylon Belt Sheath
- Individual Weight 4.7oz

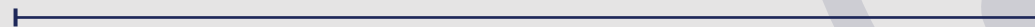

OVERALL LENGTH: 8 IN





# BULLSEYE® THROWING CYLINDERS - 4 PACK



BLISTER ITEM: 1193147 UPC: 661120655473

Look no further than the Bullseye® Throwing Cylinders! This pack includes four stainless steel, perfectly-sized throwing cylinders that are beveled on all sides to ensure they always find their target. Plus, the embroidered carrying case provides safe and easy transport. Whether you're throwing for fun or vying for the championship title, this is the perfect pack for you!

## PRODUCT FEATURES

- All sides are beveled to ensure they always find their target
- Pack of four so you have multiple chances to throw
- Embroidered carrying case for safe and easy transport



OVERALL LENGTH: 3 IN



Smith & Wesson®

**BATONS**

# QUICK RELEASE BATONS



## 21" BATON

BOX ITEM: 1117242 UPC: 661120081180

## 24" BATON

BOX ITEM: 1117241 UPC: 661120081197

This steel construction baton enables you to always be at the ready. With push-button collapsing, it is easy to deploy and retract. The baton easily collapses into a compact size for easy carrying and a rapid deployment.

## PRODUCT FEATURES

- 4140 Steel Construction
- Rubberized Grip Handles
- Push Button Collapsing
- Threaded End Caps
- 360° Rotating Synthetic Sheath

### Handle Length

- 21" Baton - 6"
- 24" Baton - 7"

### Weight

- 21" Baton - 22.08oz
- 24" Baton - 24.16oz

### 360° Rotating Sheath



8.8"



9.9"

24" Expanded Length



21" Expanded Length



# COLLAPSIBLE BATONS



## 21" BATON

BOX ITEM: 1100094 UPC: 661120076148

BLISTER ITEM: 1100095 UPC: 661120076155

## 26" BATON

BOX ITEM: 1100096 UPC: 661120081197

BLISTER ITEM: 1100097 UPC: 661120076179

Made from 4130 seamless alloy steel tubing with HRC (rockwell hardness) 46-47. Its textured and raised rubber handle provides a firm grip and has a tensile strength of 6639 lbf (3011 kgf) and a bending strength of 4056 lbf (1840 kgf). With a patent pending window punch you have protection at your fingertips. Included is a 360-degree sheath.

## PRODUCT FEATURES

- 4130 SEAMLESS ALLOY STEEL TUBING
- Textured and Raised Rubber Handle
- HRC Rockwell Hardness 46-47
- 360-Degree Sheath
- Patent-Pending Window Punch
- Tensile Strength 6639 lbf (3011 kgf)
- Bending Strength 4056 lbf (1840 kgf)



# SMALL COLLAPSIBLE BATON



## S&W COLLAPSIBLE BATON 12"

BOX ITEM: SWBAT12B UPC: 28634705863

CLAM PACK ITEM: SWBAT12BCP UPC: 28634705870

## PRODUCT FEATURES

- Includes Handheld Sheath for Jogging, Walking and Hiking
- Pocket Clip
- Steel: STKM-11A Carbon Steel
- Handle Material: STKM-11A Carbon Steel
- Handle Length: 5" (12.7 cm)
- Overall Length: 12.1" (30.7 cm)
- Weight: 8.9oz



*Closed*



**OVERALL LENGTH: 12.1 IN**

# COLLAPSIBLE BATON



## S&W® COLLAPSIBLE BATON 16"

BOX ITEM: SWBAT16H UPC: 28634703012

CLAM PACK ITEM: SWBAT16HCP UPC: 28634703166

## S&W® COLLAPSIBLE BATON 21"

BOX ITEM: SWBAT21H UPC: 28634703029

CLAM PACK ITEM: SWBAT21HCP UPC: 28634703173

## S&W® COLLAPSIBLE BATON 24"

BOX ITEM: SWBAT24H UPC: 28634703036

CLAM PACK ITEM: SWBAT24HCP UPC: 28634703180

## S&W® COLLAPSIBLE BATON 26"

BOX ITEM: SWBAT26H UPC: 28634703043

CLAM PACK ITEM: SWBAT26HCP UPC: 28634703197

## PRODUCT FEATURES

- 4130 Seamless Alloy Steel Tubing W/Hrc 46-47
- Textured and Raised Rubber Handle
- 1680 Denier Outer Shell Belt Sheath (M.O.L.L.E. Compatible)
- Tensile Strength: 6639 lbf (3011 kgf)
- Bending Strength: 4056 lbf (1840 kgf)



Handle Length 6.6" (16.7 cm)  
Weight 13.9 oz.

16"



Handle Length 8.2" (20.8 cm)  
Weight 1 lb. 1.1 oz.

21"



Handle Length 9.2" (23.3 cm)  
Weight 1 lb. 2.9 oz.

24"



Handle Length 9.7" (24.6 cm)  
Weight 1 lb. 3.8 oz.

26"



Sheath Comes with All Collapsible Batons

# LITE COLLAPSIBLE BATON



## S&W® LITE COLLAPSIBLE BATON 21"

BOX ITEM: SWBAT21LT UPC: 28634709434

## S&W® LITE COLLAPSIBLE BATON 26"

BOX ITEM: SWBAT26LT UPC: 28634709458

## PRODUCT FEATURES

- Tip Steel - 1215MS Free Cutting Steel
- First Shaft Steel - STKM 11A Carbon Steel
- Middle Shaft Material - 7076 T6 Aluminum
- 7076 T6 Aluminum Handle w/Soft Foam Grip
- 1680 Denier Outer Shell Belt Sheath
- Tensile Strength: 2653 lbf (1204 kgf)
- Bending Strength: 1986 lbf (901 kgf)

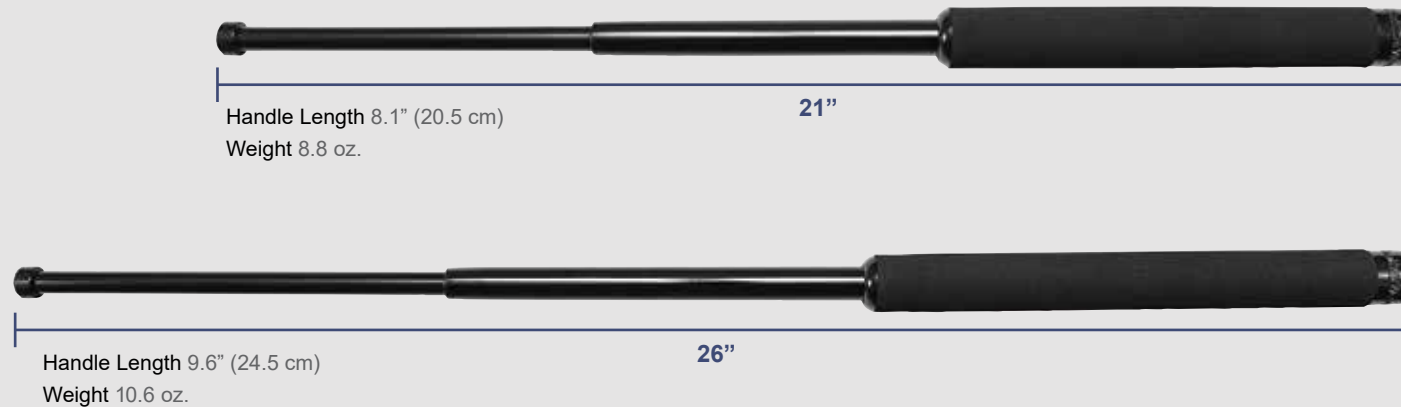

*Sheath Comes with All Collapsible Batons*





**Smith & Wesson®**

**TOOLS AND ACCESSORIES**

# CYLINDER SPINNER

BOX ITEM: 1199997 UPC: 661120747574

This Smith & Wesson® Cylinder Spinner is perfect for those who want to keep their hands busy. With six removable brass colored plated simulated cartridges, this spinner is perfect for those who need a distraction or a tool to focus. The polished body and precision bearing ensures that it spins smoothly. Whether you're at home or in the office, this spinner is the perfect novelty for you.

## PRODUCT FEATURES

- Ball Bearing Spindle
- 6 Removable Brass Colored Simulated Cartridges
- Polished Finished Body



OVERALL WIDTH: 2 IN



# FOLDING PEN KNIFE



BOX ITEM: 1122571 UPC: 661120081296

BLISTER ITEM: 1117236 UPC: 661120081319

A combination pen and pocket knife, we built this knife for finesse with its edge and with its ink. The fine blade, aluminum construction, and ball-point pen give you precise control no matter your medium to withstand extreme conditions.

## PRODUCT FEATURES

- Stainless Steel Blade
- Aluminum Body
- Liner Lock
- Thumb Stud
- Twist-Out Writing Point
- Pocket Clip



HANDLE LENGTH: 6 IN

BLADE LENGTH: 1.6 IN



OVERALL LENGTH: 7.6 IN



# TACTICAL STYLUS BLACK TACTICAL PEN

BOX ITEM: SWPEN3BK UPC: 28634705498



## PRODUCT FEATURES

- T6061 Aircraft Aluminum
  - Includes Stylus Tip
  - Schmidt P900M Parker Style
  - Black Ball Point Pen Refill
  - Weight 1.6oz
- 
- Material - CNC Machined Black T6061 Aircraft Aluminum
  - Overall Length 5.4"
  - Weight 1.6oz



OVERALL LENGTH: 5.4 IN



# SCREW CAP TACTICAL PEN

BOX ITEM: SWPENBK UPC: 28634702411



## PRODUCT FEATURES

- T6061 Aircraft Aluminum
- Screw Cap Pen
- Schmidt P900M Parker Style
- Black Ball Point Pen Refill



OVERALL LENGTH: 5.7 IN

# UNIVERSAL ARMORER TOOL



BOX ITEM: SWUAT1 UPC: 28634705887

## PRODUCT INCLUDES

- 1/16" Allen Wrench
- 1/16" Roll Tip Punch Pin
- 1/8" Roll Tip Punch Pin
- 1/16" Flat Tip Punch Pin
- 1/8" Flat Tip Punch Pin
- M&P® Slave Pin
- 1/8" Solid Punch Pin
- 1/8" Brass Flat Tip Punch Pin
- 1/8" Brass Roll Tip Punch Pin
- 1/32" Cut Tip Punch Pin
- 1/16" Cut Tip Punch Pin
- 1/8" Cut Tip Punch Pin

- Aluminum
- Overall Length 5.1" (13.0 cm)
- Weight: 2oz



OVERALL LENGTH: 5.1 IN

# KNIFE SHARPENER

BLISTER ITEM: 1117198 UPC: 661120081142



Never have another dull moment with our on-the-go, easily accessible knife sharpener. Always be prepared with ceramic and carbide sharpeners and a Torx driver to ensure your blades will always be in peak condition.

## PRODUCT FEATURES

- Ceramic and Carbide Sharpeners
- Glass Reinforced Nylon Body
- Tapered Diamond Honing Stone
- T8 Torx Driver
- Keychain





# SMITH & WESSON® MULTI-TOOL

CLAM PACK ITEM: SWMT1CP UPC: 28634706877



## PRODUCT FUNCTIONS

- Needle Nose Plier
- Regular Plier
- Wire Cutter
- Fine Edge Blade
- Small Phillips Head
- Can Opener
- Ruler
- Fine Grit File
- Hexagon Wrench—3 Sizes
- Bottle Opener
- Nail Puller
- Large Screwdriver
- Small Screwdriver
- Saw

- Overall Length 6.5"
- Weight 8.6 oz.



LENGTH: 4.2 IN

# VEHICLE ESCAPE TOOL



BLISTER ITEM: 1117239    UPC: 661120081357

This tool is the ultimate copilot when it comes to emergencies on the road. With a built-in seatbelt cutter and a hardened glass breaking hammer, its small but mighty aluminum construction will always have your back no matter what. And when you don't need it to save your life, it will save the life of your electronics with dual USB charging ports.

## PRODUCT FEATURES

- Seatbelt Cutter
- Glass Breaker
- Solid All Metal Construction
- 2 Port USB Chargers



# .38 SPEC TOOL-A-LONG MULTI-TOOL

SKU: 1095031 UPC: 661120416098

## PRODUCT FEATURES

- Stainless steel construction
- 7 different tools in a compact design
- Includes aluminum carabiner

- Clam Size: 3.875"W x 6.25"H x 0.5"D
- Case Pack: 4

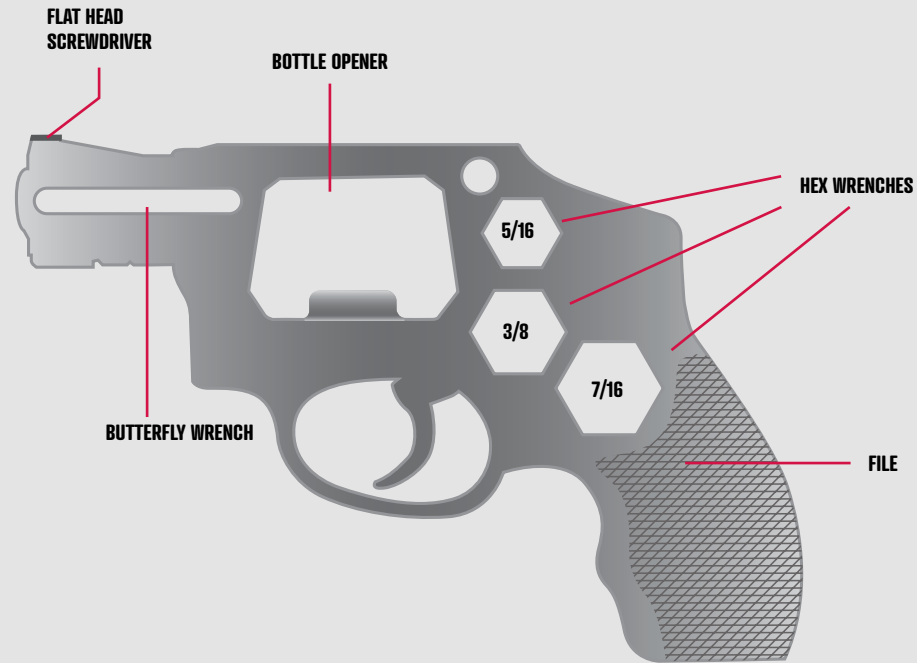

# PLEXIGLASS STANDING DISPLAY

SKU: SWPLEXSD UPC: 28634707577





Smith & Wesson<sup>®</sup>, M&P<sup>®</sup> and M2.0<sup>®</sup>  
are trademarks of Smith & Wesson  
Brands, Inc. used under license.



**Smith & Wesson<sup>®</sup>**