



PRODUCT CATALOG
2024



NEW PRODUCTS
2024

CROWFOOT WRENCH



The Wheeler® Crowfoot Wrenches are professional-grade, hardened steel wrenches specifically crafted to stand up to the rigors of AR-15/LR308 assembly, maintenance, and modification; allowing you to tackle any AR building or maintenance task. Each wrench is purposely-built with precision to exact fitment allowing you to install handguards, muzzle devices, and barrels with confidence. Each dual-ended wrench is designed to be multifunctional; delivering exceptional value.



MUZZLE DEVICE & BUFFER TUBE 3/4" & 5/8"
PRODUCT: 1199465 UPC: 661120749325

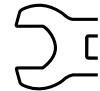

AR-15/LR308 BARREL NUT 1 1/8" & 1 1/4"
PRODUCT: 1199466 UPC: 661120749332



AR-15/LR308 BARREL NUT 1 5/16" & 30MM
PRODUCT: 1199467 UPC: 661120749349

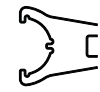

CASTLE NUT STANDARD & LOW PROFILE
PRODUCT: 1199468 UPC: 661120749356



MIL-SPEC BARREL NUT AR-15 & LR308/AR-10
PRODUCT: 1199464 UPC: 661120749318

KEY BENEFITS

- INNOVATIVE DUAL-ENDED WRENCH DESIGN PERFORMS MULTIPLE FUNCTIONS PER WRENCH
- COMPATIBLE WITH XL F.A.T. WRENCH OR ANY OTHER 1/2" DRIVE TORQUE WRENCHES
- PROFESSIONAL-GRADE, HARDENED STEEL CONSTRUCTION WITHSTANDS EXTREME USE & RESISTS BENDING
- BLACK OXIDE FINISH PREVENTS RUST AND CORROSION WHILE EXTENDING THE LIFE OF THE WRENCH
- 5 MULTI-FUNCTION WRENCHES TO CHOOSE FROM PERFORM 12 DIFFERENT FUNCTIONS FOR INSTALLING MIL-SPEC AND AFTERMARKET AR-15/LR-308 COMPONENTS

CROWFOOT WRENCH ASSORTMENT



5/8"-3/4"
BUFFER TUBE, A2 FIXED
STOCK & MUZZLE DEVICE



STANDARD & LOW PROFILE
CASTLE NUT & M4
ADJUSTABLE STOCK



AR-15 & LR308/AR-10
AR-15 FREE FLOAT BARREL NUT
AR-15 MIL-SPEC BARREL NUT
AR-10 BARREL NUT
LR308 BARREL NUT



1 5/16" x 30MM
AR-15/LR308 AFTERMARKET
HANDGUARDS



1 1/8" x 1 1/4"
AR-15/LR308 AFTERMARKET
HANDGUARDS



XL F.A.T. WRENCH® COMPLETE AR-15 CROWFOOT SET

PRODUCT: 1196191

UPC: 661120749295



The Wheeler® XL F.A.T. Wrench® Complete AR-15 Crowfoot Set is the ultimate kit for the in-home or professional gunsmith looking to build AR-15's and LR-308's with mil-spec or aftermarket components. The set includes the XL F.A.T. Wrench that adjusts from 10-150 ft-lbs., providing more than enough torque required to complete any AR-15/LR308 build function with precision and confidence. Whether you're attaching accessories, assembling upper and lower receivers, or performing routine maintenance, you can be confident that the XL F.A.T. Wrench Crowfoot Set will deliver consistent and accurate torque every single time. At the core of the kit are 5 multi-function crowfoot wrenches that perform 12 different tasks thanks to their innovative, dual-ended design. These professional-grade, hardened steel wrenches are specifically crafted to stand up to the rigors of AR-15/LR308 assembly, maintenance, and modification; empowering you to tackle any AR building task. All the contents are neatly organized and secured in a premium latching hard case.

KEY BENEFITS

- COMPLETE KIT FOR DIY GUN BUILDERS AND GUNSMITHS INSTALLING AND MAINTAINING MIL-SPEC AND AFTERMARKET AR-15/LR308 COMPONENTS
- RATCHETING 1/2" TORQUE WRENCH DELIVERS 10-150 FT-LB TORQUE RANGE NEEDED FOR HIGH TORQUE APPLICATIONS
- PROFESSIONAL-GRADE, HARDENED STEEL CROWFOOT WRENCHES WITHSTAND EXTREME USE & RESIST BENDING
- PREMIUM LATCHING HARD CASE ORGANIZES AND PROTECTS CONTENTS, KEEPING THEM SECURE AND PROTECTED DURING TRANSPORT AND STORAGE
- 5 VERSATILE, DUAL-ENDED CROWFOOT WRENCHES PERFORM 12 FUNCTIONS

SET INCLUDES:

- XL F.A.T. WRENCH
- 11/8" - 11/4" CROWFOOT WRENCH
- BARREL NUT CROWFOOT WRENCH
- 30MM - 15/16" CROWFOOT WRENCH
- 5/8" - 3/4" CROWFOOT WRENCH
- CASTLE NUT CROWFOOT WRENCH



XL F.A.T. WRENCH® COMPLETE AR-15 CROWFOOT SET



5/8"-3/4"
BUFFER TUBE, A2 FIXED STOCK & MUZZLE DEVICE



STANDARD & LOW PROFILE
CASTLE NUT & M4 ADJUSTABLE STOCK



AR-15 & LR308/AR-10
AR-15 FREE FLOAT BARREL NUT
AR-15 MIL-SPEC BARREL NUT
AR-10 BARREL NUT
LR308 BARREL NUT



1 5/16" x 30MM
AR-15/LR308 AFTERMARKET HANDGUARDS



1 1/8" x 1 1/4"
AR-15/LR308 AFTERMARKET HANDGUARDS

XL F.A.T. WRENCH® AR-15 CROWFOOT SET

PRODUCT: 1199887

UPC: 661120749301

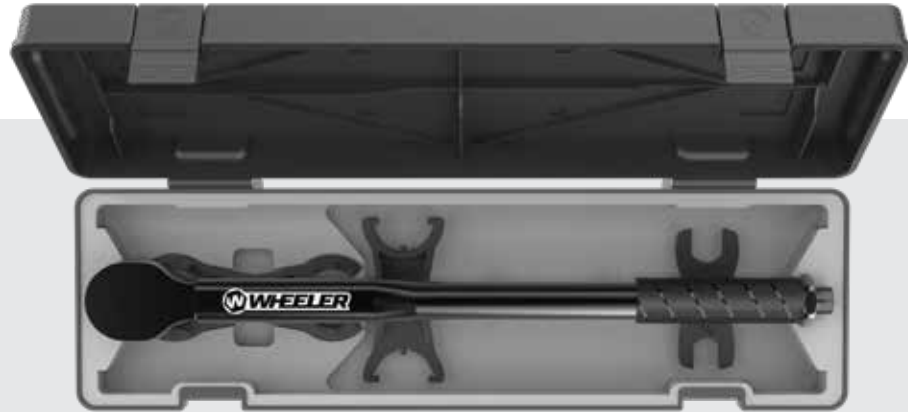

The Wheeler® XL F.A.T. Wrench® AR-15 Crowfoot Set is a must-have for any DIY gun builder or professional gunsmith looking to build mil-spec AR-15's and LR308's. The set includes the XL F.A.T. Wrench that adjusts from 10-150 ft-lbs., providing more than enough torque required to complete any AR-15/LR308 build function with precision and confidence. Whether you're attaching accessories, assembling upper and lower receivers, or performing routine maintenance, you can be confident that the XL F.A.T. Wrench Crowfoot Set will deliver consistent and accurate torque every single time. At the core of the kit are 3 multi-function crowfoot wrenches that perform 8 different tasks thanks to their innovative, dual-ended design. These professional-grade, hardened steel wrenches are specifically crafted to stand up to the rigors of AR-15/LR308 assembly, maintenance, and modification; empowering you to tackle any AR building task. All the contents are neatly organized and secured in a premium latching hard case.

KEY BENEFITS

- ESSENTIAL KIT FOR DIY GUN BUILDERS AND GUNSMITHS INSTALLING AND MAINTAINING MIL-SPEC AR-15/LR308 COMPONENTS
- RATCHETING ½" TORQUE WRENCH DELIVERS 10-150 FT-LB TORQUE RANGE NEEDED FOR HIGH TORQUE APPLICATIONS
- PROFESSIONAL-GRADE, HARDENED STEEL CROWFOOT WRENCHES WITHSTAND EXTREME USE & RESIST BENDING
- PREMIUM LATCHING HARD CASE ORGANIZES AND PROTECTS CONTENTS, KEEPING THEM SECURE AND PROTECTED DURING TRANSPORT AND STORAGE
- 3 VERSATILE, DUAL-ENDED CROWFOOT WRENCHES PERFORM 8 FUNCTIONS

SET INCLUDES:

- XL F.A.T. WRENCH
- BARREL NUT CROWFOOT WRENCH
- 5/8" - 3/4" CROWFOOT WRENCH
- CASTLE NUT CROWFOOT WRENCH

XL F.A.T. WRENCH® AR-15 CROWFOOT SET

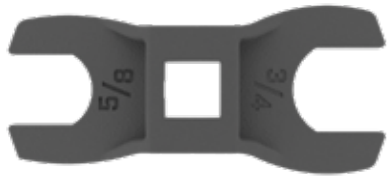

5/8"-3/4"

BUFFER TUBE, A2 FIXED STOCK & MUZZLE DEVICE



STANDARD & LOW PROFILE

CASTLE NUT & M4 ADJUSTABLE STOCK



AR-15 & LR308/AR-10

AR-15 FREE FLOAT BARREL NUT
AR-15 MIL-SPEC BARREL NUT
AR-10 BARREL NUT
LR308 BARREL NUT



ULTIMATE AR-15 ARMORER'S KIT

PRODUCT: 4002649

UPC: 661120750536



The Wheeler® Pro Series Ultimate AR-15 Armorer's Kit has been engineered and designed with both the DIY gun-builder and the seasoned professional gunsmith in mind. This 28-piece kit of professional-grade tools redefines what it means to build, maintain, accurize, and customize an AR-15. Each tool in this comprehensive collection is purpose-built for precision and reliability, giving you the confidence that you have the right tools for the job. From installing springs and detents in a lower receiver, lapping upper receivers for accuracy, or torquing down muzzle devices and handguards, rest assured this kit has it covered. No more worries about damaged or misplaced tools with the premium latching hard case that ensures that your tools remain protected and organized wherever you go.

KEY BENEFITS

- PROFESSIONAL ARMORER'S GRADE KIT BUILT FROM THE GROUND UP FOR THE DIY GUN BUILDER OR PROFESSIONAL GUNSMITH
- 28-PIECE KIT INCLUDES ALL THE TOOLS NEEDED TO BUILD, ACCURIZE, AND MAINTAIN AN AR-15
- PREMIUM LATCHING HARD CASE WITH HANDLE KEEPS CONTENTS PROTECTED AND SECURE DURING TRANSPORT

KIT INCLUDES: 28 PIECE

- 1/2" DRIVE XL F.A.T. WRENCH®
- COMPLETE SET OF MULTI-FUNCTION CROWFOOT WRENCHES
- AR-15 ROLL PIN INSTALL TOOL KIT
- UPPER RECEIVER LAPPING KIT
- AR-15 ARMORER'S BENCH BLOCK
- GAS BLOCK TAPER PIN REMOVAL TOOL
- AR-15 PIVOT AND ROLL PIN INSTALLATION TOOL
- AR-15 MAGWELL VISE BLOCK
- UPPER/PIC RAIL VISE BLOCK
- AR-15 UPPER RECEIVER ACTION ROD
- LATCHING HARD CASE WITH HANDLE



ULTIMATE AR-15 ARMORER'S KIT



1/2" DRIVE XL F.A.T. WRENCH®



COMPLETE SET OF
MULTI-FUNCTION CROWFOOT
WRENCHES



AR-15 ROLL PIN INSTALL TOOL KIT



UPPER RECEIVER LAPPING KIT

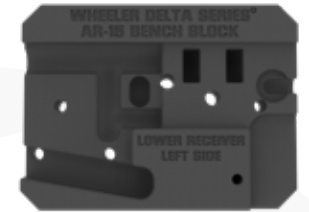

AR-15 ARMORER'S BENCH BLOCK



AR-15 MAGWELL VISE BLOCK



UPPER/PIC RAIL VISE BLOCK



AR-15 UPPER RECEIVER ACTION ROD



GAS BLOCK TAPER PIN
REMOVAL TOOL



AR-15 PIVOT PIN INSTALLATION TOOL



AR-15 ARMORER'S KIT

PRODUCT: 4005282

UPC: 661120750635



The Wheeler® Pro Series AR-15 Armorer's Kit has been engineered and designed with both the DIY gun builder and the seasoned professional gunsmith in mind. This 18-piece kit of professional-grade tools contains all the essential tools that you need to completely build and maintain an AR-15. Each tool in this collection is purpose-built for precision and reliability, giving you the confidence that you have the right tools for the job. From installing springs and detents in lower receivers, muzzle devices, and handguards, rest assured this kit has it covered. No more worries about damaged or misplaced tools with the latching hard case that ensures that your tools remain protected and organized wherever you go.

KEY BENEFITS

- PROFESSIONAL ARMORER'S GRADE KIT BUILT FROM THE GROUND UP FOR THE DIY GUN-BUILDER OR PROFESSIONAL GUNSMITH
- 18-PIECE KIT INCLUDES ALL THE TOOLS FOR MAINTAINING AND BUILDING AN AR-15
- LATCHING HARD CASE WITH HANDLE KEEPS CONTENTS PROTECTED AND SECURE DURING TRANSPORT

KIT INCLUDES: 18 PIECE

- 1/2" DRIVE TORQUE WRENCH
- AR-15 ROLL PIN INSTALL TOOL KIT
- AR-15 ARMORER'S BENCH BLOCK
- AR-15 PIVOT PIN INSTALLATION TOOL
- AR-15 MAGWELL VISE BLOCK
- UPPER/PIC RAIL VISE BLOCK
- AR-15 UPPER RECEIVER ACTION ROD
- PROFESSIONAL ARMORER'S WRENCH



AR-15 ARMORER'S KIT



1/2" DRIVE TORQUE WRENCH



AR-15 ROLL PIN INSTALL TOOL KIT



AR-15 ARMORER'S BENCH BLOCK



AR-15 PIVOT PIN INSTALLATION TOOL

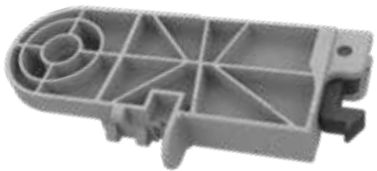

AR-15 MAGWELL VISE BLOCK



UPPER/PIC RAIL VISE BLOCK



AR-15 UPPER RECEIVER ACTION ROD



PROFESSIONAL ARMORER'S WRENCH

30 PIECE HEX/TORX BENCHTOP SCREWDRIVER SET

PRODUCT: 4002882

UPC: 661120750574



Experience unmatched convenience and organization in your workspace with the Wheeler® 30 Piece Hex/Torx Benchtop Screwdriver Set. Engineered to be an all-in-one tool assortment, this comprehensive collection contains 10 SAE Hex, 10 Metric Hex and 10 Torx screwdrivers to cover a wide range of common fasteners, guaranteeing you have the right tool for the job. Features include color-coded handles and markings offering quick identification of each screwdriver type and size, ensuring you spend less time searching for the right tool. Textured, rubber over-molded handles fit comfortably in the hand, increasing grip while reducing hand strain. The black phosphate-coated shafts protect against rust and corrosion, giving you peace of mind that your tools will be long-lasting and look great on your bench for years to come. The sturdy benchtop stand ensures that your tools stay organized, preventing tool loss and time spent looking for misplaced tools. The versatile 3-piece modular stand not only keeps the tools organized but also detaches for ultimate portability.

KEY BENEFITS

- COMPREHENSIVE 30 PIECE SCREWDRIVER SET ENGINEERED TO BE AN ALL-IN-ONE TOOL ASSORTMENT FOR COMMON SAE/METRIC HEX OR TORX FASTENERS
- INCLUDED BENCHTOP STAND ENSURES AN ORGANIZED WORKSPACE, EFFECTIVELY PREVENTING TOOL LOSS AND THE TIME-CONSUMING SEARCH FOR MISPLACED TOOLS
- RUBBER OVER-MOLDED, TEXTURED HANDLES WITH IMPROVED ERGONOMICS, INCREASE GRIP WHILE REDUCING HAND STRAIN
- COLOR-CODED HANDLES WITH SIZE MARKINGS ALLOW FOR QUICK IDENTIFICATION AND MINIMIZES THE TIME SPENT SEARCHING FOR THE RIGHT SCREWDRIVER
- BLACK PHOSPHATE COATING ON THE DRIVER PREVENTS RUST AND CORROSION WHILE KEEPING THE SET LOOKING GOOD FOR YEARS



METRIC HEX (MM): 1.5 / 2 / 2.5 / 3 / 4 / 5 / 6 / 7 / 8 / 10



SAE HEX (INCH): 3/32 / 7/64 / 1/8 / 9/64 / 5/32 / 3/16 / 7/32 / 1/4 / 5/16 / 3/8



TORX: T7 / T8 / T9 / T10 / TT15 / TT20 / TT25 / TT27 / TT30 / TT40

10 PIECE METRIC HEX BENCHTOP SCREWDRIVER SET



Experience unmatched convenience and organization in your workspace with the Wheeler® 10 Piece Metric Hex Benchtop Screwdriver Set. Engineered to be an all-in-one tool assortment for common Metric Hex fasteners, this 10-piece driver set ranges from 1.5mm-10mm, guaranteeing that you're equipped with the right tools for every task. Features include color-coded handles and markings offering quick identification of each screwdriver type and size, ensuring you spend less time searching for the right tool. Textured, rubber over-molded handles fit comfortably in the hand, increasing grip while reducing hand strain. The black phosphate-coated shafts protect against rust and corrosion, giving you peace of mind that your tools will be long-lasting and look great on your bench for years to come. The sturdy benchtop stand ensures that your tools stay organized, preventing tool loss and time spent looking for misplaced tools. The versatile stand not only keeps the tools organized but also attaches to Wheeler's other Benchtop Screwdriver Sets, allowing you to build the ultimate collection of benchtop tools.

PRODUCT: 4005281

UPC: 661120750628

KEY BENEFITS

- COMPLETE SCREWDRIVER SET ENGINEERED TO BE AN ALL-IN-ONE TOOL ASSORTMENT FOR COMMON METRIC HEX FASTENERS (1.5MM-10MM)
- INCLUDED BENCHTOP STAND ENSURES AN ORGANIZED WORKSPACE, EFFECTIVELY PREVENTING TOOL LOSS AND THE TIME-CONSUMING SEARCH FOR MISPLACED TOOLS
- RUBBER OVER-MOLDED, TEXTURED HANDLES WITH IMPROVED ERGONOMICS, INCREASE GRIP WHILE REDUCING HAND STRAIN
- COLOR-CODED HANDLES WITH SIZE MARKINGS ALLOW FOR QUICK IDENTIFICATION AND MINIMIZES THE TIME SPENT SEARCHING FOR THE RIGHT SCREWDRIVER
- BLACK PHOSPHATE COATING ON THE DRIVER PREVENTS RUST AND CORROSION WHILE KEEPING THE SET LOOKING GOOD FOR YEARS



METRIC HEX (MM): 1.5 / 2 / 2.5 / 3 / 4 / 5 / 6 / 7 / 8 / 10

10 PIECE SAE HEX BENCHTOP SCREWDRIVER SET



Experience unmatched convenience and organization in your workspace with the Wheeler® 10 Piece SAE Hex Benchtop Screwdriver Set. Engineered to be an all-in-one tool assortment for common SAE Hex fasteners, this 10-piece driver set ranges from 3/32" to 3/8", guaranteeing that you're equipped with the right tools for every task. Features include color-coded handles and markings offering quick identification of each screwdriver type and size, ensuring you spend less time searching for the right tool. Textured, rubber over-molded handles fit comfortably in the hand, increasing grip while reducing hand strain. The black phosphate-coated shafts protect against rust and corrosion, giving you peace of mind that your tools will be long-lasting and look great on your bench for years to come. The sturdy benchtop stand ensures that your tools stay organized, preventing tool loss and time spent looking for misplaced tools. The versatile stand not only keeps the tools organized but also attaches to Wheeler's other Benchtop Screwdriver Sets, allowing you to build the ultimate collection of benchtop tools.

PRODUCT: 4005280

UPC: 661120750611

KEY BENEFITS

- COMPLETE SCREWDRIVER SET ENGINEERED TO BE AN ALL-IN-ONE TOOL ASSORTMENT FOR COMMON SAE HEX FASTENERS (3/32"-3/8")
- INCLUDED BENCHTOP STAND ENSURES AN ORGANIZED WORKSPACE, EFFECTIVELY PREVENTING TOOL LOSS AND THE TIME-CONSUMING SEARCH FOR MISPLACED TOOLS
- RUBBER OVER-MOLDED, TEXTURED HANDLES WITH IMPROVED ERGONOMICS, INCREASE GRIP WHILE REDUCING HAND STRAIN
- COLOR-CODED HANDLES WITH SIZE MARKINGS ALLOW FOR QUICK IDENTIFICATION AND MINIMIZES THE TIME SPENT SEARCHING FOR THE RIGHT SCREWDRIVER
- BLACK PHOSPHATE COATING ON THE DRIVER PREVENTS RUST AND CORROSION WHILE KEEPING THE SET LOOKING GOOD FOR YEARS



SAE HEX (INCH): 3/32 / 7/64 / 1/8 / 9/64 / 5/32 / 3/16 / 7/32 / 1/4 / 5/16 / 3/8

10 PIECE TORX BENCHTOP SCREWDRIVER SET



Experience unmatched convenience and organization in your workspace with the Wheeler® 10 Piece Torx Benchtop Screwdriver Set. Engineered to be an all-in-one tool assortment for common Torx fasteners, this 10-piece driver set ranges from T7-T40, guaranteeing that you're equipped with the right tools for every task. Features include color-coded handles and markings offering quick identification of each screwdriver type and size, ensuring you spend less time searching for the right tool. Textured, rubber over-molded handles fit comfortably in the hand, increasing grip while reducing hand strain. The black phosphate-coated shafts protect against rust and corrosion, giving you peace of mind that your tools will be long-lasting and look great on your bench for years to come. The sturdy benchtop stand ensures that your tools stay organized, preventing tool loss and time spent looking for misplaced tools. The versatile stand not only keeps the tools organized but also attaches to Wheeler's other Benchtop Screwdriver Sets, allowing you to build the ultimate collection of benchtop tools.

PRODUCT: 4005278

UPC: 661120750604

KEY BENEFITS

- COMPLETE SCREWDRIVER SET ENGINEERED TO BE AN ALL-IN-ONE TOOL ASSORTMENT FOR COMMON TORX FASTENERS (T7-T40)
- INCLUDED BENCHTOP STAND ENSURES AN ORGANIZED WORKSPACE, EFFECTIVELY PREVENTING TOOL LOSS AND THE TIME-CONSUMING SEARCH FOR MISPLACED TOOLS
- RUBBER OVER-MOLDED, TEXTURED HANDLES WITH IMPROVED ERGONOMICS, INCREASE GRIP WHILE REDUCING HAND STRAIN
- COLOR-CODED HANDLES WITH SIZE MARKINGS ALLOW FOR QUICK IDENTIFICATION AND MINIMIZES THE TIME SPENT SEARCHING FOR THE RIGHT SCREWDRIVER
- BLACK PHOSPHATE COATING ON THE DRIVER PREVENTS RUST AND CORROSION WHILE KEEPING THE SET LOOKING GOOD FOR YEARS



TORX: T7 / T8 / T9 / T10 / TT15 / TT20 / TT25 / TT27 / TT30 / TT40

DIGITAL F.A.T. WRENCH® FIREARM ACCURIZING TORQUE



The Wheeler® Digital F.A.T. Wrench® (Firearm Accurizing Torque) brings even more precise torque settings to the handheld torque screwdriver. This amazing digital handheld torque wrench lets you apply repeatable torque with precision. Equipped with a generous torque adjustment range of 5-100 in-lbs., the Digital F.A.T. Wrench can tackle a wide variety of common gunsmithing tasks like tightening installing red dot sights, scope rings, bases, and other fasteners to their exact torque specification. The dual audible and visual indicators tell the user exactly when the desired torque setting has been achieved, safeguarding against over-torqued or broken fasteners. The driver features a magnetized tip to prevent bits from falling out and a textured, rubber over-mold that improves ergonomics and grip while reducing hand strain during high torque applications. The driver shafts and bits all have a black phosphate coating that prevents rust and corrosion and extends tool life; guaranteeing that your tools will look great for years to come. All the tools are neatly organized and secured in a premium latching hard case that easily stacks on top of other Wheeler screwdriver sets for smart, convenient storage.

PRODUCT: 4001001

UPC: 661120746997

KEY BENEFITS

- TORQUE ADJUSTMENT RANGE OF 5-100 IN-LBS. COVERS A WIDE VARIETY OF COMMON GUNSMITHING TASKS INCLUDING LOW TORQUE RED DOT SIGHTS
- LCD SCREEN FEATURES LIVE AND PEAK MODES FOR MEASURING TORQUE
- AUDIBLE AND VISUAL INDICATORS WHEN DESIRED TORQUE IS REACHED
- RUBBERIZED HANDLE IMPROVES ERGONOMICS FOR ENHANCED COMFORT AND GRIP, REDUCING HAND STRAIN AND FATIGUE
- HOLLOW-GROUND FLAT BITS CREATE A PRECISE FIT TO PREVENT DAMAGE TO SCREWS AND FIREARMS
- PHOSPHATE COATING ON BITS AND SHAFT PREVENTS RUST AND CORROSION, KEEPING THEM LOOKING GOOD FOR YEARS TO COME
- PREMIUM LATCHING HARD CASE ORGANIZES AND PROTECTS CONTENTS, KEEPING THEM SECURE AND PROTECTED DURING TRANSPORT AND STORAGE



FLAT: #10 / #11 / #32



SAE HEX (INCH): 3/32 / 7/64 / 5/32



TORX: T15 / T20



SPECIALTY: LEUPOLD/BUEHLER / HEX TO SQUARE ADAPTER

F.A.T. WRENCH® FIREARM ACCURIZING TORQUE

PRODUCT: 4001002

UPC: 661120746980



The Wheeler® F.A.T. Wrench® (Firearm Accurizing Torque) brings perfect consistency to every screw on your rifle. This amazing, industry-standard handheld torque wrench lets you apply repeatable, accurate torque. Why is this important? Because precisely tightened screws and mounts prevent damage to optics and firearms and decrease the chances of failure in the field. Equipped with an adjustable torque range that delivers 10-65 in-lbs., it's engineered to tackle a wide variety of common gunsmithing tasks like tightening scope bases and rings, action screws, and more with precision. The driver features a magnetized tip to prevent bits from falling out and a textured, rubber over-mold that improves ergonomics and grip while reducing hand strain during high torque applications. The 10 included bits are treated with a black phosphate coating that prevents rust and corrosion and extends tool life; guaranteeing that your tools will look great for years to come. All the contents are neatly organized and secured in a premium latching hard case that easily stacks on top of other Wheeler screwdriver sets for smart, convenient storage.

KEY BENEFITS

- TORQUE ADJUSTMENT RANGE OF 10-65 IN-LBS. FOR A WIDE VARIETY OF GUNSMITHING TASKS WHEN PRECISION IS A MUST
- RUBBERIZED HANDLE IMPROVES ERGONOMICS FOR ENHANCED COMFORT AND GRIP, REDUCING HAND STRAIN AND FATIGUE
- HOLLOW-GROUND FLAT BITS CREATE A PRECISE FIT TO PREVENT DAMAGE TO SCREWS AND FIREARMS
- INCLUDES 10 LONG-LASTING BITS MADE WITH HARDENED S2 STEEL BITS
- PHOSPHATE COATING ON BITS AND SHAFT PREVENTS RUST AND CORROSION, KEEPING THEM LOOKING GOOD FOR YEARS TO COME
- PREMIUM LATCHING HARD CASE ORGANIZES AND PROTECTS CONTENTS, KEEPING THEM SECURE AND PROTECTED DURING TRANSPORT AND STORAGE



FLAT: #10 / #11 / #32



SAE HEX (INCH): 3/32 / 7/64 / 5/32



TORX: T15 / T20



SPECIALTY: LEUPOLD/BUEHLER / HEX TO SQUARE ADAPTER



100 PIECE PROFESSIONAL F.A.T. WRENCH® SCREWDRIVER SET

FIREARM ACCURIZING TORQUE

PRODUCT: 4001004

UPC: 661120747000



Take gunsmithing to the next level with the Wheeler® 100-Piece Professional F.A.T. Wrench® Screwdriver Set. The combination of our iconic F.A.T. Wrench (Firearm Accurizing Torque) with 97 screwdriver bits and adapters makes this set a gunsmith's dream. Equipped with an adjustable torque range that delivers 10-65 in-lbs., the F.A.T. Wrench is engineered to tackle a wide variety of common gunsmithing tasks like tightening scope bases and rings, action screws, and more with precision. Both the F.A.T. Wrench and the 1/4" driver feature magnetized tips and rubber over-molded handles that improve ergonomics and grip while reducing hand strain. The driver shafts and bits all have a black phosphate coating that prevents rust and corrosion and extends tool life; guaranteeing that your tools will look great for years to come. All the tools are neatly organized and secured in a premium latching hard case that easily stacks on top of other Wheeler screwdriver sets for smart, convenient storage.

KEY BENEFITS

- COMPREHENSIVE SET OF FLAT, PHILLIPS, SQUARE, SAE/METRIC HEX, TORX, AND SPECIALTY BITS FOR MANY COMMON FASTENERS
- INCLUDED F.A.T. WRENCH ACHIEVES PERFECT TORQUE WITHOUT CAUSING DAMAGE TO THE FASTENER
- HOLLOW-GROUND FLAT BITS CREATE A PRECISE FIT TO PREVENT DAMAGE TO SCREWS AND FIREARMS
- RUBBER OVER-MOLDED HANDLES IMPROVE ERGONOMICS AND INCREASE GRIP WHILE REDUCING HAND STRAIN
- MAGNETIZED DRIVER TIPS SECURELY HOLD BITS, ENSURING THEY WILL NOT FALL OUT DURING USE
- BLACK PHOSPHATE COATING PREVENTS CORROSION AND EXTENDS THE LIFE OF THE DRIVER; KEEPING THE DRIVER AND BITS LOOKING GREAT FOR YEARS
- PREMIUM LATCHING HARD CASE ORGANIZES AND PROTECTS CONTENTS, KEEPING THEM SECURE AND PROTECTED DURING TRANSPORT AND STORAGE

Regular bits cause damage & are a poor fit



HOLLOW GROUND BITS

Hollow-ground flat bits create precise fit to prevent damage to screws and firearms















100 PIECE PROFESSIONAL F.A.T. WRENCH® SCREWDRIVER SET

FIREARM ACCURIZING TORQUE



-  **FLAT:** #1-#6 / #8 / #13-#16 / #18-#21 / #27-#30 / #32-#35 / #38 / #39 / #41 / #45 / #47
-  **SAE HEX (INCH):** .05 / 1/16 / 5/64 / 3/32 / 7/64 / 1/8 / 9/64 / 5/32 / 3/16 / 7/32 / 1/4 / 5/16 / 3/8
-  **METRIC HEX (MM):** 1.5 / 2 / 2.5 / 3 / 3.5 / 4 / 5 / 5.5 / 6 / 7 / 8 / 9 / 10
-  **TORX:** T5 / T6 / T7 / T8 / T9 / T10 / TT15 / TT20 / TT25 / TT27 / TT30 / TT35 / TT40
-  **PHILLIPS:** PH0 / PH1 / PH2 / PH3 / PH2 (LONG)
-  **SQUARE:** 1 / 2 / 3
-  **PIN (INCH):** 0.062 / 0.093 / 0.118 / 0.125
-  **METRIC NUT DRIVER:** 5 / 5.5 / 6 / 7 / 8 / 10 / 12
-  **SAE NUT DRIVER (INCH):** 3/16 / 1/4 / 9/32 / 5/16 / 11/32 / 3/8 / 7/16 / 1/2
-  **SPECIALTY:** LEUPOLD/BUEHLER



100 PIECE PROFESSIONAL SCREWDRIVER SET



Look no further for the ultimate screwdriver set. The Wheeler® 100 Piece Professional Screwdriver Set is the perfect addition to any handyman or professional looking to upgrade their toolbox or workbench. Wheeler's largest bit assortment includes SAE and Metric nut drivers, hollow-ground flat, Phillips, Torx, SAE and Metric hex bits, and more; equipping you with the tools to tackle any job. The two included drivers feature magnetized tips and rubber over-molded handles that improve ergonomics and grip while reducing hand strain. The driver shafts and bits all have a black phosphate coating that prevents rust and corrosion and extends tool life; guaranteeing that your tools will look great for years to come. All the tools are neatly organized and secured in a premium latching hard case that easily stacks on top of other Wheeler screwdriver sets for smart, convenient storage.

PRODUCT: 4001003

UPC: 661120747017

KEY BENEFITS

- COMPREHENSIVE SET OF FLAT, PHILLIPS, SQUARE, SAE/METRIC HEX, TORX, AND SPECIALTY BITS FOR MANY COMMON FASTENERS
- RUBBER OVER-MOLDED HANDLES IMPROVE ERGONOMICS AND INCREASE GRIP WHILE REDUCING HAND STRAIN
- MAGNETIZED DRIVER TIPS SECURELY HOLD BITS, ENSURING THEY WILL NOT FALL OUT DURING USE
- BLACK PHOSPHATE COATING PREVENTS CORROSION AND EXTENDS THE LIFE OF THE DRIVER; KEEPING THE DRIVER AND BITS LOOKING GREAT FOR YEARS
- PREMIUM LATCHING HARD CASE ORGANIZES AND PROTECTS CONTENTS, KEEPING THEM SECURE AND PROTECTED DURING TRANSPORT AND STORAGE

Regular bits
cause damage &
are a poor fit



HOLLOW GROUND BITS











Hollow-ground flat bits create precise fit to
prevent damage to screws and firearms





100 PIECE PROFESSIONAL SCREWDRIVER SET



-  **FLAT:** #1-#6 / #8 / #13-#16 / #18-#21 / #27-#30 / #32-#35 / #38 / #39 / #41 / #45 / #47
-  **SAE HEX (INCH):** .05 / 1/16 / 5/64 / 3/32 / 7/64 / 1/8 / 9/64 / 5/32 / 3/16 / 7/32 / 1/4 / 5/16 / 3/8
-  **METRIC HEX (MM):** 1.5 / 2 / 2.5 / 3 / 3.5 / 4 / 5 / 5.5 / 6 / 7 / 8 / 9 / 10
-  **TORX:** T5 / T6 / T7 / T8 / T9 / T10 / TT15 / TT20 / TT25 / TT27 / TT30 / TT35 / TT40
-  **PHILLIPS:** PH0 / PH1 / PH2 / PH3 / PH2 (LONG)
-  **SQUARE:** 1 / 2 / 3
-  **PIN (INCH):** 0.062 / 0.093 / 0.118 / 0.125
-  **METRIC NUT DRIVER:** 5 / 5.5 / 6 / 7 / 8 / 10 / 12
-  **SAE NUT DRIVER (INCH):** 3/16 / 1/4 / 9/32 / 5/16 / 11/32 / 3/8 / 7/16 / 1/2
-  **SPECIALTY:** LEUPOLD/BUEHLER / HEX ADAPT-1/4" DRIVE



89 PIECE PROFESSIONAL GUNSMITHING SCREWDRIVER SET

PRODUCT: 4001008

UPC: 661120747055



Whether you are a professional or in-home gunsmith, the Wheeler® 89 Piece Professional Gunsmithing Screwdriver Set is a must-have staple in your toolset. Unlike other screwdriver suppliers, Wheeler's engineers measured the screws on over one hundred modern and antique firearms to ensure that we offered specialty bits for every situation. Whether you are working on a Browning® Superposed, a Remington® 700, a Smith & Wesson® revolver, or a Colt® single action, you will find that there is a bit to fit every screw on your gun. The two included drivers feature magnetized tips and rubber over-molded handles that improve ergonomics and grip while reducing hand strain. The driver shafts and bits all have a black phosphate coating that prevents rust and corrosion and extends tool life; guaranteeing that your tools will look great for years to come. All the contents are neatly organized and secured in a premium latching hard case that easily stacks on top of other Wheeler screwdriver sets for smart, convenient storage.

KEY BENEFITS

- INCLUDES 15 ESSENTIAL BITS MADE SPECIFICALLY FOR A VARIETY OF STOCKS, SCOPE BASES, GRIPS, AND MORE
- HOLLOW-GROUND FLAT BITS CREATE A PRECISE FIT TO PREVENT DAMAGE TO SCREWS AND FIREARMS
- RUBBER OVER-MOLDED HANDLES IMPROVE ERGONOMICS AND INCREASE GRIP WHILE REDUCING HAND STRAIN
- MAGNETIZED DRIVER TIPS SECURELY HOLD BITS, ENSURING THEY WILL NOT FALL OUT DURING USE
- BLACK PHOSPHATE COATING PREVENTS CORROSION AND EXTENDS THE LIFE OF THE DRIVER; KEEPING THE DRIVER AND BITS LOOKING GREAT FOR YEARS
- PREMIUM LATCHING HARD CASE ORGANIZES AND PROTECTS CONTENTS, KEEPING THEM SECURE AND PROTECTED DURING TRANSPORT AND STORAGE

Regular bits cause damage & are a poor fit



HOLLOW GROUND BITS

Hollow-ground flat bits create precise fit to prevent damage to screws and firearms





89 PIECE PROFESSIONAL GUNSMITHING SCREWDRIVER SET



- ⊖ **FLAT:** #1 - #47
- ⬡ **SAE HEX (INCH):** 1/16 / 5/64 / 3/32 / 7/64 / 1/8 / 9/64 / 5/32 / 3/16
- ⊗ **PHILLIPS:** PH0 / PH1 / PH2 / PH3 / PH2 (LONG)
- ☆ **TORX:** T10 / TT15 / TT20
- ⦿ **PIN (INCH):** 0.062 / 0.093 / 0.118 / 0.125
- Ⓢ **SPECIALTY:** LEUPOLD/BUHLER / RUGER-WEAVER / GLOCK / RUGER / M1 / EXT. MAUSER MILLET / REDFIELD / S&W REBOUND / HEX ADAPT.-1/4" DRIVE / 1911 GRIP

PERFECT FOR



PISTOLS

SHOTGUNS



RIFLES



REVOLVERS

65 PIECE HEX/TORX SCREWDRIVER SET

PRODUCT: 4001007

UPC: 661120747048



The Wheeler® 65 Piece Hex/Torx Screwdriver Set features a complete assortment of SAE/Metric Hex and Torx bits. Also included is a handy precision micro-driver with 20 micro bits that give you the confidence that you have the right tools to tackle any job regardless of size. The rubber over-molded handles provide a comfortable fit in the hand, enhancing grip and eliminating hand strain. The black phosphate-coated shafts and bits ensure your tools are shielded from rust and corrosion, guaranteeing longevity and a lasting appearance. All the contents are neatly organized and secured in a premium latching hard case that easily stacks on top of other Wheeler screwdriver sets for smart, convenient storage.

KEY BENEFITS

- COMPREHENSIVE HEX/TORX SCREWDRIVER SET ENGINEERED TO BE AN ALL-IN-ONE TOOL ASSORTMENT FOR SAE/METRIC HEX OR TORX FASTENERS
- INCLUDES CONVENIENT PRECISION MICRO-DRIVER FOR EYEGLASSES, KNIFE CLIPS, OR OTHER SMALL FASTENERS
- PREMIUM LATCHING HARD CASE ORGANIZES AND PROTECTS CONTENTS, KEEPING THEM SECURE AND PROTECTED DURING TRANSPORT AND STORAGE
- RUBBER OVER-MOLDED, TEXTURED HANDLES WITH IMPROVED ERGONOMICS INCREASE GRIP WHILE REDUCING HAND STRAIN
- BLACK PHOSPHATE COATING ON THE DRIVER AND BITS PREVENTS RUST AND CORROSION WHILE KEEPING THE SET LOOKING GOOD FOR YEARS

65 PIECE HEX/TORX SCREWDRIVER SET



- ⊖ **FLAT:** #2 / #6 / #14 / #19 / #26 / #32
- ⬡ **SAE HEX (INCH):** 3/32 / 7/64 / 1/8 / 9/64 / 3/16 / 3/8 / 5/32 / 5/16 / 7/32 / 1/4
- ⬡ **MICRO SAE HEX (INCH):** .028 / .035 / .05 / 1/16 / 3/32 / 5/64
- ⬡ **METRIC HEX (MM):** 2.5 / 3 / 4 / 4.5 / 5 / 5.5 / 6 / 7 / 8 / 10
- ⬡ **MICRO METRIC HEX (MM):** 0.7 / 0.9 / 1.3 / 1.5 / 2 / 2.5
- ☆ **TORX:** T8 / T9 / T10 / TT15 / TT20 / TT25 / TT27 / TT30 / TT35 / TT40 / TT45
- ☆ **MICRO TORX:** T1 / T2 / T3 / T4 / T5 / T6 / T7
- ⊗ **PHILLIPS:** PH00 (MICRO) / PH0 / PH1 / PH2 / PH3
- Ⓢ **SPECIALTY:** LEUPOLD/BUEHLER

43 PIECE GUNSMITHING SCREWDRIVER SET

PRODUCT: 4001006

UPC: 661120747031



Screwdrivers are one of the most important and used gunsmithing tools and the Wheeler® 43 Piece Gunsmithing Screwdriver Set is no exception. Unlike other screwdriver suppliers, Wheeler's engineers measured the screws on over one hundred modern and antique firearms to make sure that we offered bits for every situation. Whether you are working on a Browning® Superposed, a Remington® 700, a Smith & Wesson® revolver, or a Colt® single action, you will find that there is a bit to fit every screw on your gun. The precise hollow-ground flat bits fit perfectly in the screw slot, preventing damage to screws or expensive firearms. The rubberized driver handle improves ergonomics for better comfort and grip while reducing hand strain and fatigue. The black phosphate coating not only adds an aesthetic touch but also acts as a barrier against corrosion and rust ensuring your tools remain in top condition for years to come. All the contents are neatly organized and secured in a premium latching hard case that easily stacks on top of other Wheeler screwdriver sets for smart, convenient storage.

KEY BENEFITS

- RUBBER OVER-MOLDED, TEXTURED HANDLES WITH IMPROVED ERGONOMICS INCREASE GRIP WHILE REDUCING HAND STRAIN
- PREMIUM LATCHING HARD CASE ORGANIZES AND PROTECTS CONTENTS, KEEPING THEM SECURE AND PROTECTED DURING TRANSPORT AND STORAGE
- BLACK PHOSPHATE COATING ON THE DRIVER AND BITS PREVENTS RUST AND CORROSION WHILE KEEPING THE SET LOOKING GOOD FOR YEARS

Regular bits
cause damage &
are a poor fit







HOLLOW GROUND BITS

Hollow-ground flat bits create precise fit to
prevent damage to screws and firearms



43 PIECE GUNSMITHING SCREWDRIVER SET



-  **FLAT:** #1 / #3 / #9 / #11 / #12 / #13 / #15 / #16 / #18 / #19 / #22 / #24 / #25 / #27 / #28 / #31 / #33 / #36 / #39 / #41
-  **SAE HEX (INCH):** 1/16 / 5/64 / 3/32 / 7/64 / 1/8 / 9/64 / 5/32 / 3/16 / 7/32 / 1/4
-  **PHILLIPS:** PH0 / PH1 / PH2 / PH3
-  **TORX:** T10 / TT15 / TT20 / TT27 / TT30
-  **SPECIALTY:** LEUPOLD/BUEHLER / HEX ADAPT.-1/4" DRIVE

PERFECT FOR



PISTOLS

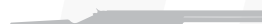

SHOTGUNS



RIFLES



REVOLVERS

36 PIECE SPACESAVER SCREWDRIVER SET

PRODUCT: 4001005

UPC: 661120747024



Small but mighty, the Wheeler® 36 Piece Spacesaver Screwdriver Set provides a convenient assortment of SAE and Metric Hex, Torx, Phillips, and Flat bits, perfect for common household and other general use tasks. The convenient compact size of this set makes it an ideal fit for range bags or household storage. The textured, rubber over-molded handles have improved ergonomics that fit comfortably in the hand, increasing grip while reducing hand strain. The black phosphate-coated shafts and bits protect against rust and corrosion, giving you peace of mind that your tools will be long-lasting and look great for years. All the contents are neatly organized and secured in a premium latching hard case that keeps the contents protected and secure. Versatility, convenience, and durability – all packaged into one compact set that's ready to accompany you wherever your work takes you.

KEY BENEFITS

- ASSORTMENT OF FLAT, PHILLIPS, TORX, SAE/METRIC HEX FIT MANY COMMON FASTENERS ENSURING YOU ALWAYS HAVE THE RIGHT TOOLS AT HAND
- CONVENIENT COMPACT SIZE IS PERFECT FOR USE AND STORAGE IN RANGE BAGS
- PREMIUM LATCHING HARD CASE ORGANIZES AND PROTECTS CONTENTS, KEEPING THEM SECURE AND PROTECTED DURING TRANSPORT AND STORAGE
- RUBBER OVER-MOLDED, TEXTURED HANDLES WITH IMPROVED ERGONOMICS INCREASE GRIP WHILE REDUCING HAND STRAIN
- BLACK PHOSPHATE COATING ON THE DRIVER AND BITS PREVENTS RUST AND CORROSION WHILE KEEPING THE SET LOOKING GOOD FOR YEARS



36 PIECE SPACESAVER SCREWDRIVER SET



⊖ FLAT: #1 / #11 / #13 / #28 / #39 / #47

⬡ SAE HEX (INCH): 1/16 / 1/8 / 3/16 / 3/32 / 5/32 / 5/64 / 7/64 / 9/64

⊗ PHILLIPS: PH0 / PH1 / PH2 / PH3

☆ TORX: T6 / T7 / T8 / T9 / T10 / T15 / T20 / T25

ULTRA SCOPE MOUNTING KIT

PRODUCT: 4001009

UPC: 661120747130



The Wheeler® Ultra Scope Mounting Kit takes all the best scope mounting tools on the market and puts them together into one ultimate kit. Level your rifle and scope, precisely torque base and scope rings, and get on target quicker with all the included professional grade tools. The Ultra Scope Mounting Kit even provides a lens pen and thread locker to keep your scope clean and your optics secure on even the largest caliber guns. All the contents are neatly organized and secured in a premium latching hard case that easily stacks on top of other Wheeler screwdriver sets for smart, convenient storage. Mount your optic with ease and confidence with the Wheeler Ultra Scope Mounting Kit.

KEY BENEFITS

- F.A.T. WRENCH WITH 10-65 IN-LBS. TORQUE RANGE REPEATABLY AND PRECISELY TORQUES SCOPE RINGS AND BASES WITHOUT RISK OF DAMAGE TO FIREARMS OR OPTICS
- PROFESSIONAL RETICLE LEVELING SYSTEM ENSURES A PERFECTLY LEVEL SCOPE
- PROFESSIONAL LASER BORE SIGHTER WITH HIGH VISIBILITY GREEN LASER TO GET ON TARGET QUICKER
- PHOSPHATE COATING ON BITS PREVENTS RUST AND CORROSION, KEEPING THEM LOOKING GOOD FOR YEARS TO COME
- PREMIUM LATCHING HARD CASE ORGANIZES AND PROTECTS CONTENTS, KEEPING THEM SECURE AND PROTECTED DURING TRANSPORT AND STORAGE

KIT INCLUDES:

- F.A.T. WRENCH
- 9 BLACK PHOSPHATE-COATED BITS & SOCKET
- PROFESSIONAL RETICLE LEVELING SYSTEM
- GREEN LASER BORE SIGHTER (BATTERY INCLUDED)
- THREAD LOCKER
- LENS PEN
- STORAGE CASE

ULTRA SCOPE MOUNTING KIT



F.A.T. WRENCH® WITH 9
BLACK PHOSPHATE-COATED
BITS & SOCKET



PROFESSIONAL RETICLE
LEVELING SYSTEM



THREAD LOCKER



LENS PEN



GREEN LASER BORE SIGHTER
(BATTERY INCLUDED)



STORAGE CASE



FEATURED PRODUCTS

F.A.T. STIX® TORQUE LIMITERS *FIREARM ACCURIZING TORQUE*



The Wheeler® F.A.T. Stix® Limiters take the guesswork out of torquing gear on the go. Each limiter is preset to a specific torque value, allowing for easy use at the range or in the field. We've got you covered with limiters ranging from 10 in-lbs. to 65 in-lbs. in 5 in-lbs. increments, ensuring you will have the right tool for the task. They precisely adjust to the specified torque, providing protection against the risk of components coming loose or causing harm to firearms and fasteners. These limiters are compatible with the Wheeler F.A.T. Stix T-Handle Driver or any other driver that accepts 1/4" bits.

KEY BENEFITS

- PRESET TO SPECIFIC IN-LB. TORQUE VALUES, REQUIRING NO ADJUSTMENTS FOR QUICK AND CONVENIENT USE
- ACCURATELY TIGHTENS TO DESIRED TORQUE SPECIFICATION, SAFEGUARDING AGAINST LOOSE COMPONENTS, DAMAGE TO FIREARMS AND STRIPPED SCREWS
- EXTREMELY ACCURATE WITHIN +/-5% ENSURING THE CORRECT TORQUE EVERY TIME
- REVERSIBLE DESIGN ALLOWS FOR TIGHTENING AND LOOSENING FASTENERS WITHOUT DAMAGE TO THE LIMITER
- COMPATIBLE WITH F.A.T. STIX T-HANDLE DRIVER OR ANY OTHER DRIVER THAT ACCEPTS 1/4" BITS

PRODUCT: 1192764	10 IN-LB	UPC: 661120747147
PRODUCT: 1192765	15 IN-LB	UPC: 661120747154
PRODUCT: 1192766	20 IN-LB	UPC: 661120747161
PRODUCT: 1192767	25 IN-LB	UPC: 661120747178
PRODUCT: 1192768	30 IN-LB	UPC: 661120747185
PRODUCT: 1192769	35 IN-LB	UPC: 661120747192
PRODUCT: 1192770	40 IN-LB	UPC: 661120747208
PRODUCT: 1192771	45 IN-LB	UPC: 661120747215
PRODUCT: 1192772	50 IN-LB	UPC: 661120747222
PRODUCT: 1192773	55 IN-LB	UPC: 661120747239
PRODUCT: 1192774	60 IN-LB	UPC: 661120747246
PRODUCT: 1192775	65 IN-LB	UPC: 661120747253



RETURNING PRODUCTS



F.A.T. STIX™

FIREARM ACCURIZING TORQUE

PRODUCT: 1136022

UPC: 661120107798

- PRESET TORQUE LIMITERS ARE QUICK AND CONVENIENT WITH NO ADJUSTMENTS REQUIRED
- ACCURATELY TIGHTENS TO DESIRED SPECIFICATION, PREVENTING DAMAGE AND STRIPPED SCREWS
- REVERSIBLE DESIGN ALLOWS FOR TIGHTENING AND LOOSENING FASTENERS WITHOUT DAMAGING THE LIMITER
- SOFT CARRY CASE ORGANIZES THE KIT AND IS IDEAL FOR PORTABILITY

Whether in the garage or on the range, tightening to the correct torque value can be the difference between success and failure. The Wheeler F.A.T. Stix set features 15, 25, 35, 45, and 65 in-lbs torque limiters to cover all of the most common applications. This set also includes 12 common bits, a 1/2" socket, and a 1/4" drive bit extension. The ergonomic T-handle design is comfortable and easy to use for a variety of tasks. The convenient carry case makes F.A.T. Stix the perfect tool for on-the-go.





SPORTER RINGS

WEAVER®/PICATINNY SCOPE RINGS

PRODUCT: 1133753	34MM LOW	UPC: 661120107866
PRODUCT: 1133754	34MM MED	UPC: 661120107873
PRODUCT: 1133755	34MM HIGH	UPC: 661120107880
PRODUCT: 1133750	30MM LOW	UPC: 661120107835
PRODUCT: 1133751	30MM MED	UPC: 661120107842
PRODUCT: 1133752	30MM HIGH	UPC: 661120107859
PRODUCT: 1133747	1" LOW	UPC: 661120107804
PRODUCT: 1133748	1" MED	UPC: 661120107811
PRODUCT: 1133749	1" HIGH	UPC: 661120107828

- REVERSIBLE LUG CREATES SECURE INTERCHANGEABLE FIT TO WEAVER AND PICATINNY RAILS
- LIGHTWEIGHT 6061 ALUMINUM CONSTRUCTION FOR DURABILITY
- OFFSET SCREWS FOR EASY ADJUSTMENTS
- AVAILABLE IN MULTIPLE HEIGHTS
- RESEALABLE PACKAGING ALLOWS FOR STORAGE AND EASILY TESTING FIT

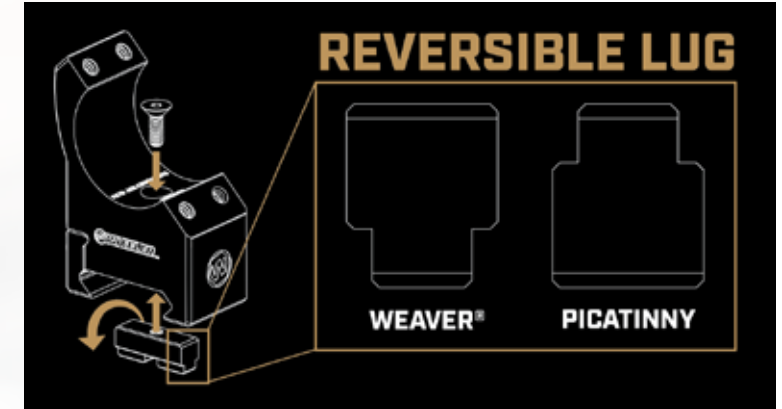

The Wheeler Weaver®/Picatinny Rings change the scope ring game. These revolutionary rings feature an easily adjustable base for conversion from Weaver to Pic Rail compatibility and back again. The durable 6061 aluminum construction will last through all your hunts and competitions. Four offset screws securely hold your scope in place.



AR ARMORER'S ULTRA KIT

PRODUCT: 156559

UPC: 661 120565598

KIT INCLUDES:

- AR-15 ARMORER'S VISE
- AR-15 COMBO TOOL
- TORQUE WRENCH
- UPPER VISE BLOCK WITH GAS TUBE ALIGNMENT OIL
- AR-15 MAINTENANCE MAT
- AR-15 ROLL PIN INSTALL TOOL KIT
- ADJUSTABLE RECEIVER LINK
- MAG/UPPER RECEIVER BRUSH
- DOUBLE-ENDED GENERAL CLEANING BRUSH
- AR-15 BORE GUIDE
- .22 CAL BORE BRUSH
- BOLT CARRIER BRUSH
- CHAMBER BRUSH
- NYLON BRUSH HANDLE
- CLEANING PICK SET
- CUSTOM CARRY CASE
- AR FRONT SIGHT TOOL
- DELTA RING TOOL
- STRAP WRENCH
- AR-15 BENCH BLOCK
- PIVOT & ROLL PIN INSTALL TOOL

The Wheeler® AR Armorer's Ultra Kit contains every premium tool needed to build and maintain your AR-15 rifle.



AR ARMORER'S PROFESSIONAL KIT

PRODUCT: 156555

UPC: 661120565550

KIT INCLUDES:

- AR-15 ARMORER'S VISE
- AR-15 COMBO TOOL
- TORQUE WRENCH
- UPPER VISE BLOCK WITH GAS TUBE ALIGNMENT OIL
- AR-15 MAINTENANCE MAT
- PIVOT & ROLL PIN INSTALL TOOL
- ADJUSTABLE RECEIVER LINK
- MAG/UPPER RECEIVER BRUSH
- DOUBLE-ENDED GENERAL CLEANING BRUSH
- AR-15 BORE GUIDE
- .22 CAL BORE BRUSH
- BOLT CARRIER BRUSH
- CHAMBER BRUSH
- NYLON BRUSH HANDLE
- CLEANING PICK SET
- CUSTOM CARRY CASE
- AR FRONT SIGHT TOOL
- DELTA RING TOOL
- STRAP WRENCH

The Wheeler® AR Armorer's Professional Kit contains premium tools needed to build and maintain your AR-15 rifle.





AR ARMORER'S ESSENTIALS KIT

PRODUCT: 156111

UPC: 661120561118

KIT INCLUDES:

- AR-15 COMBO TOOL
- TORQUE WRENCH
- UPPER VISE BLOCK WITH GAS TUBE ALIGNMENT OIL
- AR-15 MAINTENANCE MAT
- PIVOT & ROLL PIN INSTALL TOOL
- AR-15 MAG WELL VISE BLOCK
- ADJUSTABLE RECEIVER LINK
- CUSTOM CARRY CASE

The Wheeler® AR Armorer's Essentials Kit contains essential tools an armorer needs to build or maintain AR-15/M16 rifles. Each tool is designed with application specific features to perform specific functions with precision and ease.





UPPER RECEIVER ACTION ROD

PRODUCT: 1100182

UPC: 661120418061

- WORKS ON ALL AR-15'S WITH STANDARD BARREL EXTENSIONS
- LOCKS INTO BARREL EXTENSION
- TORQUE BARREL NUTS WITHOUT RISKING DAMAGE TO UPPER
- NO REMOVAL OF OPTICS OR SIGHTS REQUIRED
- WORK ON YOUR UPPER FROM MULTIPLE ANGLES WITHOUT SLIPPING IN VICE JAWS
- GAS PORT ALIGNMENT TOOL

The Wheeler® Upper Receiver action rod reduces stress on upper receiver during barrel installation or removal.

PATS: AOB.COM/PATENTS



PROFESSIONAL ARMORER'S WRENCH

PRODUCT: 1099561

UPC: 661120418047

- STEEL CONSTRUCTION
- OVERMOLDED RUBBER HANDLE W/ TORQUE SPECS
- MIL-SPEC BARREL NUT WRENCH
- FREE FLOAT BARREL NUT WRENCH
- BUFFER TUBE CASTLE NUT WRENCH
- A2 FLASH HIDER WRENCH
- RIFLE RECEIVER EXTENSION WRENCH
- 1/2" TORQUE WRENCH COMPATIBLE

The Wheeler® Professional Armorer's Wrench is designed to be the last wrench you'll need for building your perfect rifle. This tool is what every gunsmith or armorer needs to be able to build or repair their AR-15.





AR COMBO TOOL WITH TORQUE WRENCH

PRODUCT: 156700

UPC: 661 120567004

- HARDENED STEEL BARREL NUT PINS
- CUTOUT FOR 3/4" FLASH HIDER
- BUFFER TUBE NUT DRIVER
- CUTOUT FOR FIXED STOCK BUFFER TOOL

Cover most of your AR-15 service needs with a single tool. An innovative layered and laminated stamped steel construction makes the Delta Series® Combo Tool the most durable AR tool available. Additionally, the included Torque wrench in the Combo pack makes this a complete set for many AR maintenance and modification needs.

AR COMBO TOOL ONLY

PRODUCT: 156999

UPC: 661 120569992





AR-15 MAINTENANCE MAT

47" X 20"

PRODUCT: 156824

UPC: 661120568247

- MADE OF PADDED NEOPRENE
- ABSORBS OILS AND SOLVENTS
- NON-SLIP RUBBER BACKING
- ROLLS UP FOR EASY STORAGE
- HAND WASHABLE

The Wheeler® AR-15 Maintenance Mat is perfect for any AR-15 owner. It features a screen printed expanded view of an AR-15 Carbine to easily identify the parts of your rifle. The Mat is made of a dark gray non-marring padded neoprene material with a durable non-skid rubber backing to protect firearm finishes while helping to keep track of small parts. Excess oils and solvents are absorbed into the mat, keeping the surface clean and dry.





AR TRIGGER GUARD

INSTALL TOOL

PRODUCT: 710907

UPC: 661120109075

- INSTALL OR CHANGE TRIGGER GUARDS QUICKLY AND EASILY
- INCLUDES INSTALL PIN AND AN UNINSTALL PIN
- PINS CONVENIENTLY STORE IN THE FRAME
- MADE OF DURABLE ALUMINUM WITH A MIL-SPEC ANODIZED SURFACE FINISH

The Wheeler® AR Trigger Guard Install Tool is designed to make quick work of installing and removing trigger guard pins.





AR ARMORER'S VISE

PRODUCT: 156224

UPC: 661120562245

- NON-SLIP RUBBER FEET CAN BE REMOVED FOR PERMANENT BENCHTOP MOUNTING
- FOREND SUPPORT CAN ACCOMMODATE DIAMETERS UP TO 2.3"
- RIGID STEEL BASE FEATURES DEPRESSIONS FOR HOLDING SPARE PARTS OR TOOLS
- FRONT AND REAR SUPPORTS ROTATE TO MULTIPLE POSITIONS AND ARE REVERSIBLE FOR MAXIMUM CUSTOMIZATION

The AR-15 platform has become the mainstay of today's Modern Sporting Rifle market. The popularity and modularity of this platform has created the need for specific tools that allow users to build, maintain and reconfigure AR's. The Wheeler® Armorer's Vise provides users an ideal foundation for all AR tasks.

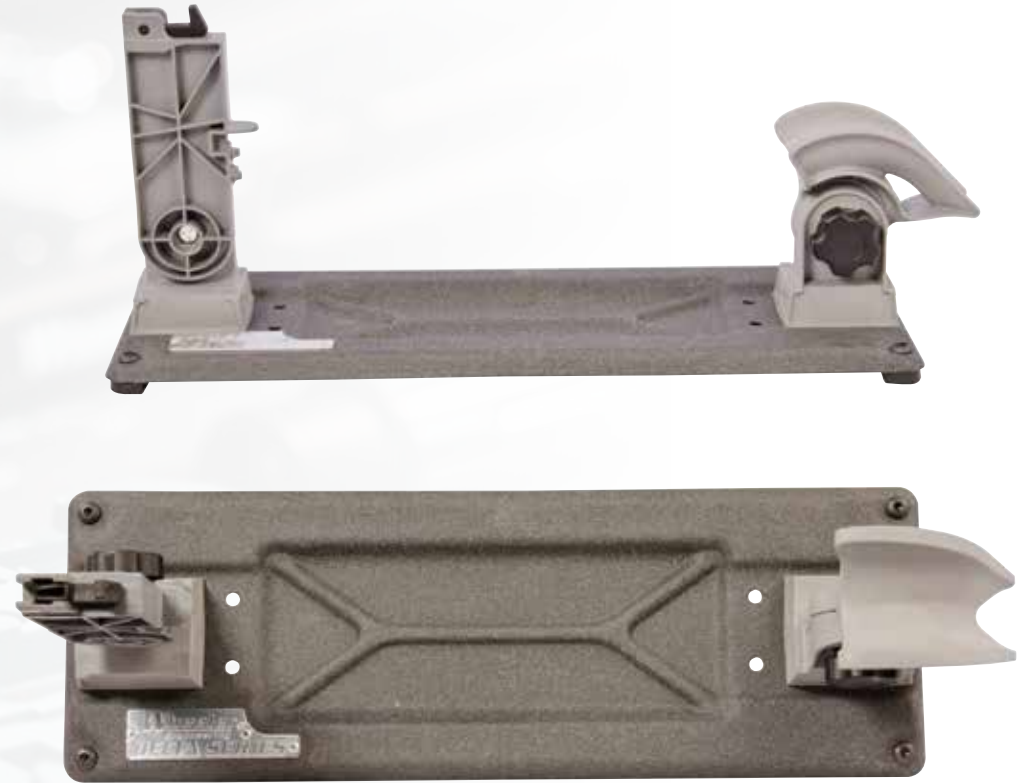



MAG WELL VISE BLOCK

PRODUCT: 156211 **AR-15** UPC: 661120562245

PRODUCT: 146200 **AR-10/LR VAR.** UPC: 661120562245

- BENCHTOP MOUNTABLE WITH INCLUDED FASTENERS
- LOCKS INTO PLACE USING MAGAZINE LOCK-ON RECEIVER
- BUILT-IN HAMMER STOP PREVENTS DAMAGE TO LOWER RECEIVER
- SOLVENT-RESISTANT POLYMER PROVIDES DURABILITY AND IS NON-MARRING TO SURFACES
- MAG WELL ARM IS REMOVABLE FOR CLAMPING IN A VISE

The Wheeler® AR-15 Mag Well Vise Block is quite possibly the handiest tool an AR-15 owner could ask for. This center support slides into the magazine well and provides a steady base for cleaning or light gunsmithing on your AR-15.

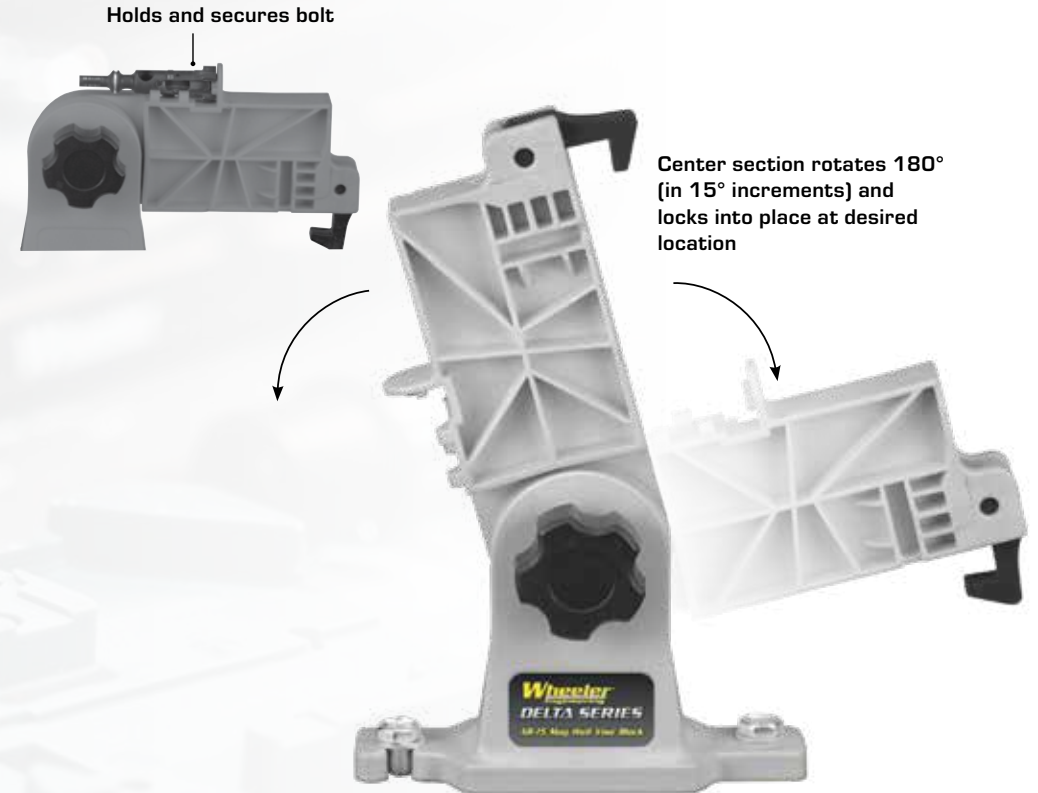



AR ARMORER'S BENCH BLOCK

PRODUCT: 156945

UPC: 661120569459

- DURABLE NON-MARRING URETHANE MATERIAL TO PROTECT GUN FINISH
- DESIGNED TO ASSIST IN ALL ASPECTS OF AN AR-15 BUILD
- IDEAL FOR CHANGING OR ADJUSTING TRIGGERS
- HOLDS LOWER SECURE FOR ROLL PIN ASSEMBLY
- PERFECT FOR GAS BLOCK PINS

Tired of trying to secure your AR parts while installing a pin, detent or spring? The Wheeler® AR-15 Bench Block is the answer! Specifically designed for AR-15 assembly and disassembly, the AR-15 Bench Block is the perfect tool. It securely holds the upper receiver, lower receiver, front sight and charging handle during assembly, disassembly and maintenance.





AR CARBON MULTI-SCRAPER

PRODUCT: 1078195

UPC: 661120411352

- CLEANS 11 SURFACES OF THE BOLT CARRIER GROUP
- FITS INSIDE AR PISTOL GRIPS
- COATED STAINLESS STEEL CONSTRUCTION

Keep carbon build-up from effecting your next shot with the Wheeler® AR Carbon Multi-Scraper. This stainless steel coated, compact tool is made to clean 11 vital surfaces of the bolt carrier group. Keep this tool on your bench or take advantage of its convenient size by storing it inside your rifle's pistol grip. This is the perfect tool for getting back to shooting quickly and effectively.



COMPACT AR MULTI-TOOL

PRODUCT: 1078948

UPC: 661120412823

- MULTI-TOOL DESIGN TO PERFORM MANY FUNCTIONS IN THE FIELD
- SATIN-FINISH, STAINLESS STEEL CONSTRUCTION
- FEATURES AN AR CARBON MULTI-SCRAPER TOOL, 5/64" HEX, 7/64" HEX, 1/8" HEX, PIVOT AND TAKEDOWN PUNCH, #2 PHILLIPS, BOLT WAIST SCRAPER, INTERIOR BCG SCRAPER, T10 TORX, T15 TORX, T20 TORX, A2 FRONT SIGHT TOOL, 3/16" FLAT, 3/4" WRENCH, 1/2" WRENCH AND A CASTLE NUT WRENCH

There is no need for a tool box at the range when you have the Wheeler® Compact AR Multi-Tool. With a satin finish and stainless steel construction, this tool is not only handy, but durable. The multi-tool design can be used to perform many different functions in the field. When you need to make adjustments, or scrape some carbon build-up, simply reach down and grab this tool out of the included nylon belt sheath and go to work. After you are finished, snap the tool back in and continue shooting.



Belt sheath included



BORE GUIDES

PRODUCT: 156213 **AR-15** UPC: 661120562139

PRODUCT: 156777 **AR-10/LR VAR.** UPC: 661120567776

PRODUCT: 777209 **300 AAC BLK.OUT** UPC: 661120772095

- PREVENTS DAMAGE TO BORE BY ALIGNING CLEANING ROD
- DURABLE ANODIZED FINISH

The Wheeler® AR-15 Bore Guide works well with .223 and .204, while the AR LR/10 Variant works well on .308. The AR-15 300 AAC Blackout Bore Guide works on any 30 caliber, 6.5 or 6.8 AR-15. The AR-15 Bore Guide inner tube diameter is .250". Fit securely in any AR-15 or AR LR/10 variant upper and can be retained in place by closing the dust cover on the upper—engaging a groove in the guide.





AR BOLT CATCH INSTALL PUNCH KIT

PRODUCT: 710906

UPC: 661120109068

- FLAT ON ONE SIDE FOR PROPER ALIGNMENT
- RUBBER OVER-MOLDED TO PREVENT DAMAGE TO FIREARM
- INCLUDES 2 STEEL PUNCHES
- 1 WITH COUNTER-BORED TIPS TO START ROLL PINS
- 1 WITH INDEXING TIPS TO FINISH ROLL PINS

The Wheeler® Bolt Catch Install Punch Kit starts bolt catch roll pins easily with the starter punch and finishes installation flush with the finishing punch.





AR DELTA RING TOOL

PRODUCT: 209943

UPC: 661120099437

- CUSTOM FORMED WIRE FITS SECURELY AROUND DELTA RING
- WELDED STEEL BRACKET FOR DURABILITY EVEN WITH STUCK OR BROKEN DELTA RINGS

The Wheeler® AR-15 Delta Ring Tool makes removing mil-spec AR-15 and M16 handguards easy by compressing the Delta Ring with one hand. Its 100% vinyl coating protects the guns finish from damage. The custom formed wire fits securely around Delta Ring. The Delta Ring Tool has a welded steel bracket for durability even with stuck or broken Delta Rings.





AR PIVOT & ROLL PIN INSTALL TOOL

PRODUCT: 156243

UPC: 661 120562436

- COMPATIBLE WITH THE AR-15, M4, OR M16
- FAST AND EFFORTLESS PIVOT SPRING AND DETENT WORK
- ROLL PIN PUNCH AND STARTER FOR ALL LOWER RECEIVER ROLL PINS
- KEY RING FOR STORAGE
- BLACK ELECTRO-COATED STEEL FOR DURABILITY

The Wheeler® AR Pivot & Roll Pin Install Tool is designed for use with the AR-15, M4 or M-16 rifles, making pivot pin spring and detent work fast and effortless. It comes with handy key ring for storage, and is made of black zinc plated steel to stand up to any job.





AR FRONT SIGHT TOOL

PRODUCT: 156437

UPC: 661120564379

- COMPATIBLE WITH ANY 1/4" HEX DRIVER
- BLACK ZINC-PLATED STEEL FOR DURABILITY

The Wheeler® AR Front Sight Tool is a 4-prong front sight tool designed to install and adjust the A2 front sight found on the AR-15, M16, and M4. It is machined from steel and has a black zinc finish to last for years. The key ring serves as a handle and helps keep the small tool accounted for. Can be used with any 1/4" hex driver.





AR UPPER VISE BLOCK

PRODUCT: 156444

UPC: 661120564447

- FITS LEFT AND RIGHT-HANDED MIL-SPEC A2 UPPER WITH CARRIER HANDLES
- FITS FLAT TOP RECEIVERS
- MADE OF NON-MARRING, SOLVENT RESISTANT POLYMER MATERIAL
- UPPER SUPPORT ROD WITH INTEGRATED ALIGNMENT ROD ENSURES BARREL NUT IS PROPERLY ALIGNED

The Wheeler® AR Upper Vise Block is the perfect product for torquing a barrel on, removing a stubborn barrel nut or for simple gun maintenance and cleaning. It is made of a non-marring, solvent resistant polymer material which can withstand almost anything you can throw at it.





AR-15 COMPLETE BRUSH SET

PRODUCT: 156715

UPC: 661120567158

KIT INCLUDES:

- MAGAZINE/UPPER RECEIVER BRUSH WITH MAGAZINE TAKE DOWN TOOL
- BOLT CARRIER BRUSH WITH 8-32 THREADS
- CHAMBER BRUSH WITH 8-32 THREADS
- .22 CAL BORE BRUSH WITH 8-32 THREADS

The Wheeler® AR-15 Complete Brush Set is specifically designed for cleaning your AR-15. The high quality nylon brushes feature an 8 x 32 thread to fit on the included cleaning handle or any 8 x 32 cleaning rod. The brush set has everything you need to clean your rifle, plus everything you need to keep your magazines clean and running reliably.





AR GAS BLOCK TAPER PIN REMOVAL TOOL

PRODUCT: 1079898

UPC: 661120412793

- WORKS ON A2 FRONT SIGHTS
- WORKS ON SMITH & WESSON SINGLE-TAPER PIN GAS BLOCKS
- WORKS ON DUAL TAPER PINS
- CONSTRUCTED FROM DURABLE TOOL STEEL

Take full control of your custom build with the Wheeler® Gas Block Taper Pin Removal Tool. Whether you have a vise, or just a ball peen hammer, the Support Block paired with the starter and finishing punches makes removing A2 style gas blocks quick and easy. Built with durable tool steel, this is a must-have for any work bench.





AR-15 ROLL PIN INSTALL TOOL KIT

PRODUCT: 952636

UPC: 661 120526360

KIT INCLUDES:

- AR BOLT CATCH INSTALL PUNCH KIT
- AR TRIGGER GUARD INSTALL TOOL
- 3 STARTER STEEL PUNCHES (1/16", 5/16", 3/32")
- 3 DRIVER STEEL PUNCHES (1/16", 5/16", 3/32")
- TWO-SIDED HAMMER
- BLOW-MOLDED STORAGE CASE

The Wheeler® AR Roll Pin Install Tool Kit is perfect for installing or removing AR roll pins without marring the firearm. The included Trigger Guard Install Tool makes installing or changing trigger guards quick and easy. The Bolt Catch Install Punch Kit is flat on one side for proper alignment.





COMPACT AR CLEANING KIT

PRODUCT: 1082251

UPC: 661120412762

KIT INCLUDES:

- AR CHAMBER BRUSH
- MULTI-FUNCTION BOLT SCRAPER TOOL
- CLEANING PICK
- COLLAPSIBLE 36" STAINLESS STEEL CLEANING ROD WITH ROTATING T-HANDLE
- THREE STAR CHAMBER CLEANING PADS
- PATCHES FOR .22 AND .30 CAL
- NYLON BRUSHES FOR .22 AND .30 CAL
- JAGS FOR .22 AND .30 CAL

Hold the power to clean your rifle in the palm of your hand with the Wheeler® Compact AR Cleaning Kit. This kit comes in a semi-rigid, zippered carry case and can be used on .22 and .30 caliber rifles. Whether you travel, clean at the range, or like to be organized at home, this kit is the perfect size for storing in small spaces, including a magazine pouch, and durable enough to take anywhere.



DELTA SERIES AR COMBO TOOL WITH TORQUE WRENCH

PRODUCT: 156700

UPC: 661120567004

- HARDENED STEEL BARREL NUT PINS
- CUTOUT FOR 3/4" FLASH HIDER
- BUFFER TUBE NUT DRIVER
- CUTOUT FOR FIXED STOCK BUFFER TUBE

Cover most of your AR-15 service needs with a single tool. An innovative layered and laminated stamped steel construction makes the Wheeler® Delta Series Combo Tool the most durable AR tool available. The included Torque wrench in the Combo pack makes this a complete set for many AR maintenance and modification needs.





AR UPPER/PIC RAIL VISE BLOCK

PRODUCT: 156888

UPC: 661120568889

- MULTI-FUNCTION DESIGN HOLDS AR-15 AND MOST AR-10/LR308 UPPERS
- EASILY SECURE ANY PIC RAIL RECEIVER OR HANDGUN
- DURABLE MACHINED ALUMINUM CONSTRUCTION

The Wheeler® AR Upper Pic Rail Vise Block is designed to securely hold AR upper receivers. It will secure AR-15 uppers by engaging the takedown lugs on the bottom of the receivers. By reversing the direction it will secure most AR-10 style uppers in the same manner. The included Pic Rail slot allows any flat top upper or handguard with a pic rail to be securely held in a vice for cleaning or maintenance.





SCOPE RING ALIGNMENT & LAPPING KITS

PRODUCT: 204061	1"	UPC: 661120040613
PRODUCT: 633266	30MM	UPC: 661120332664
PRODUCT: 1081035	34MM	UPC: 661120412557
PRODUCT: 305172	1" & 30MM	UPC: 661120051725
PRODUCT: 781366	1" ALIGN. BAR	UPC: 661120813668

KIT INCLUDES:

- LAPPING BAR(S)
- LAPPING BAR HANDLE
- ALIGNMENT BARS
- 220 GRIT LAPPING BAR COMPOUND

Aligning and lapping of new rings should become the standard practice whenever a scope is installed on a quality firearm. The alignment bars in this kit provide for perfect alignment of both rings and will also diagnose any misalignment problem, vertical or horizontal, giving you the opportunity to fix the problem before damaging the scope or experiencing frustration at the range.



RECEIVER LAPPING TOOL

PRODUCT: 156757 **AR-15** UPC: 661120567578

PRODUCT: 1082227 **AR-10/LR VAR.** UPC: 661120412564

PRODUCT: 342303 **LAP. COMP. KIT** UPC: 661120423034

KIT INCLUDES:

- FLEX DRIVER SHAFT IS COMPATIBLE WITH ELECTRIC DRILL
- 220 GRIT LAPPING COMPOUND
- LAPPING BAR FEATURES STEEL CONSTRUCTION WITH BLACK OXIDE FINISH

Get the perfect fit with the Wheeler® Receiver Lapping Tool. Lapping a receiver ensures a perfectly square and true surface for the barrel to mate against, enhancing accuracy. Honing the surface can produce optimal positioning of barrel nut so ideal torque can be achieved along with proper gas tube hole alignment.





LAPPING COMPOUNDS

REPLACEMENT GRITS

PRODUCT: 885040 **220 GRIT** UPC: 661120190578

PRODUCT: 378413 **320 GRIT** UPC: 661120190349

PRODUCT: 395155 **600 GRIT** UPC: 661120090113

- REPLACEMENT COMPOUND FOR BORE LAPPING KIT.



SPACESAVER SCREWDRIVER SET

PRODUCT: 664507

UPC: 661 120645078

- DURABLE S2 TOOL STEEL
- DURABLE NO-SLIP OVERMOLDED HANDLE
- MAGNETIC BIT RETENTION IN DRIVER
- CONVENIENT HINGED STORAGE CASE

INCLUDED INTERCHANGEABLE BITS:

FLAT: #1 / #11 / #13 / #15 / #19 / #22 / #25 / #28 / #33 / #39

HEX: 1/16" / 5/64" / 3/32" / 1/8" / 9/64" / 7/64" / 5/32" / 3/16"

TORX: T10 / T15 / T20

PHILLIPS: PH0 / PH1 / PH2 / PH3



43 PIECE GUNSMITHING SCREWDRIVER SET

PRODUCT: 954621

UPC: 661120546214

- DURABLE S2 TOOL STEEL
- DURABLE NO-SLIP OVERMOLDED HANDLE
- MAGNETIC BIT RETENTION IN DRIVER
- CONVENIENT HINGED STORAGE CASE

INCLUDED INTERCHANGEABLE BITS:

FLAT: #1 / #3 / #8 / #11 / #12 / #13 / #15 / #16 / #18 / #19
#22 / #24 / #25 / #27 / #28 / #31 / #33 / #36 / #39 / #41

HEX: 1/16" / 5/64" / 3/32" / 7/64" / 1/8" / 9/64"
5/32" / 3/16" / 7/32" / 1/4"

TORX: T10 / T15 / T20 / T27 / T30

PHILLIPS: PH0 / PH1 / PH2 / PH3

SPECIALTY: LUEPOLD-BUEHLER





55 PIECE HEX/TORX SCREWDRIVER SET

PRODUCT: 1081958

UPC: 661120412731

- DURABLE S2 TOOL STEEL
- DURABLE NO-SLIP OVERMOLDED HANDLE
- MAGNETIC BIT RETENTION IN DRIVER
- CONVENIENT HINGED STORAGE CASE

INCLUDED INTERCHANGEABLE BITS:

TORX: T1 / T2 / T3 / T4 / TT5 / TT6 / TT7 / TT8 / TT9 / TT10
TT15 / TT20 / TT25 / TT30 / TT35 / TT40 / TT45 / TT50

METRIC HEX (mm): 0.7 / 0.9 / 1.3 / 1.5 / 2 / 2.5 / 3
4 / 4.5 / 5 / 5.5 / 6 / 7 / 8 / 10

SAE HEX (in): 0.028 / 0.035 / 0.05 / 1/16 / 5/64 / 3/32
7/64 / 1/8 / 9/64 / 5/32 / 3/16 / 7/32 / 1/4 / 5/16 / 3/8

OTHER: PH1 / PH2 / FL14 / FL32

DRIVER HANDLE: 1/4" / 4mm





72 PIECE GUNSMITHING SCREWDRIVER SET

PRODUCT: 776737

UPC: 661120767374

- 54 HOLLOW-GROUND FLAT BITS
- DURABLE S2 TOOL STEEL
- TWO NO-SLIP OVERMOLDED HANDLES
- CONVENIENT HINGED STORAGE CASE

INCLUDED INTERCHANGEABLE BITS:

FLAT: #1 - #47

HEX: 1/16" / 5/64" / 3/32" / 1/8" / 9/64"

5/32" / 3/16"

TORX: T10 / T15 / T20

PHILLIPS: PH0 / PH1 / PH2 / PH3



89 PIECE PROFESSIONAL GUNSMITHING SCREWDRIVER SET

PRODUCT: 562194

UPC: 661120621942

- 54 HOLLOW-GROUND FLAT BITS
- DURABLE S2 TOOL STEEL
- TWO NO-SLIP OVERMOLDED HANDLES
- 2 1/4" SHAFT EXTENSION
- HEX-TO-SQUARE DRIVE ADAPTER
- CONVENIENT HINGED STORAGE CASE

INCLUDED INTERCHANGEABLE BITS:

FLAT: #1 - #47

HEX: 1/16" / 5/64" / 3/32" / 1/8" / 9/64"

5/32" / 3/16"

TORX: T10 / T15 / T20

PHILLIPS: PH0 / PH1 / PH2 / PH3

PIN: 0.062" / 0.093" / 0.118" / 0.125"

SPECIALTY: RUGER-WEAVER / GLOCK / LUEPOLD-BUEHLER / RUGER

MAUSER / MILLET / 1911 GRIP / PHILLIPS LONG / REDFIELD / S&W REBOUND



21 PIECE EXPANSION SET

PRODUCT: 954671

UPC: 661120546719

- GREAT ADDITION TO THE 72 OR 89 PIECE SCREWDRIVER SETS
- DURABLE S2 TOOL STEEL
- FEATURES PLASTIC STORAGE TRAY THAT FITS PERFECTLY INTO THE CURRENT CASE

INCLUDED INTERCHANGEABLE BITS:

TORX: T6 / T7 / T8 / T10 / T15 / T20 / T27 / T30

HEX (mm): 2.5 / 3 / 3.5 / 4 / 4.5 / 5 / 5.5 / 6 / 7 / 8





GUNSMITHING SCREWDRIVER UPGRADE KIT

PRODUCT: 748555

UPC: 661120485551

- 15 GUNSMITHING SPECIALTY BITS
- DURABLE S2 TOOL STEEL

Contains the 15 Specialty Bits, shaft extension and square to hex adapter found in the 89 Piece Professional Gunsmithing Screwdriver Set. Upgrade your 72 Piece Screwdriver Set or 43 Piece Set with these gunsmithing specialty bits.

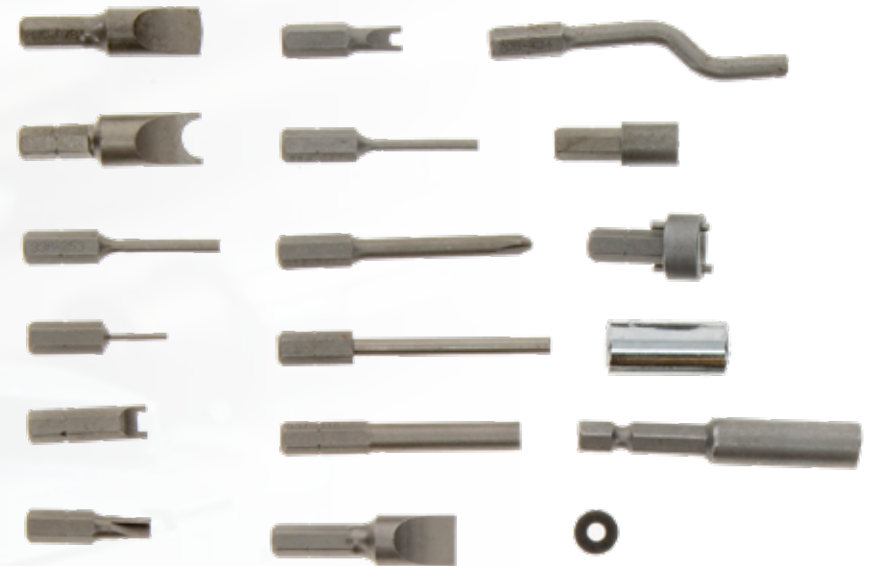

45 PIECE SAE/METRIC HEX & TORX KEY SET

PRODUCT: 1081959

UPC: 661120412748

- INCLUDES SAE/METRIC HEX AND TORX KEYS
- HARD PLASTIC STORAGE CASE ORGANIZES KEYS BY SIZE

Store all your key sets in one place with the Wheeler® 45-Piece Key Set. This convenient set allows you to store all SAE and Metric Hex and Torx keys together. Never again will you have to dig around for odd or different sizes, simply open your kit, turn to the page you need and continue working.

INCLUDED KEYS:

TORX: T1 / T2 / T3 / T4 / T5 / T6 / T7 / T8 / T9 / T10 / T15
T20 / T25 / T30 / T35

METRIC HEX (mm): 0.7 / 0.9 / 1.3 / 1.5 / 2 / 2.5 / 3
4 / 4.5 / 5 / 5.5 / 6 / 7 / 8 / 10

SAE HEX (in): 0.028 / 0.035 / 0.05 / 1/16 / 5/64 / 3/32
7/64 / 1/8 / 9/64 / 5/32 / 3/16 / 7/32 / 1/4 / 5/16 / 3/8



30 PIECE P-HANDLE DRIVER SET

PRODUCT: 1081957

UPC: 661120412724

- FEATURES 30 SAE/METRIC HEX AND TORX DRIVERS
- ERGONOMIC P-HANDLE DESIGN ALLOWS FOR SECURE AND COMFORTABLE GRIP
- MOLDED STAND CAN SIT ON BENCH TOP OR MOUNT TO WALL

Complete your workbench with the Wheeler 30-Piece P-Handle Driver Set. The sleek molded stand design paired with its ability to be mounted on the wall allow for quick, convenient access to the SAE Hex, Metric Hex and Torx drivers, making it the perfect addition to any work shop.

INCLUDED BITS:

TORX: T7 / T8 / T9 / T10 / T15 / T20 / T25 / T27 / T30 / T40

METRIC HEX (mm): 1.5 / 2 / 2.5 / 3 / 4 / 5 / 6 / 7 / 8 / 10

SAE HEX (in): 3/32 / 7/64 / 1/8 / 9/64 / 5/32 / 3/16

7/32 / 1/4 / 5/16 / 3/8



MICRO MULTI-DRIVER TOOL PEN

PRODUCT: 1082257

UPC: 661120412809

- ALUMINUM HANDLE CONSTRUCTION
- INCLUDES 17 INTERCHANGEABLE BITS
- STORES 5 BITS INTERNALLY
- COMPACT BIT HOLDER CARRIES 12 BITS

Have the bits you need on hand for your most intricate gunsmithing projects with the Wheeler® Micro Multi-Driver Tool Pen. Its convenient shape fits comfortably in your hand and is equipped to hold 5 of your most used bits.

INCLUDED INTERCHANGEABLE BITS:

HEX: H0.9 / H1.3 / H1.5 / H2

SLOTTED: SL1.5 / SL2 / SL2.5 / SL3

PHILLIPS: PH00 / PH0 / PH1

TORX: T5 / T6 / T7

TORX SECURITY: TR8 / TR9 / TR10



MULTI-DRIVER TOOL PEN

PRODUCT: 1082256

UPC: 661120412816

- ALUMINUM HANDLE CONSTRUCTION
- STORES 6 BITS INTERNALLY
- INCLUDES 13 INTERCHANGEABLE BITS
- COMPACT BIT HOLDER CARRIES 7 BITS

Have the bits you need, on hand, with the Wheeler® Multi-Driver Tool Pen. Who wants to drag their entire screwdriver set to the range? This small tool is perfect for travel. Its convenient shape fits comfortably in your hand and is equipped to hold 6 of your most used bits.

INCLUDED INTERCHANGEABLE BITS:

HEX SAE: H5/64 / H3/32 / H1/8 / H5/32

SLOTTED: SL3 / SL4 / SL4.5

PHILLIPS: PH1 / PH2

TORX: T10 / T15 / T20 / T25





PRECISION SCREWDRIVER SET

PRODUCT: 564018

UPC: 661 120640189

- CHROME PLATED STEEL BITS
- EXTENDABLE HANDLE FROM 3 3/4" - 5 1/2"
- 5 3/4" FLEXIBLE EXTENSION SHAFT
- PRECISION-FORMED BITS FOR FASTENER ENGAGEMENT

The Wheeler® Precision Screwdriver Set is a 58 piece precision screwdriver set is the perfect size to throw in your range bag. Use the extra small bits for adjusting everything from sights to lasers and even your safety glasses.





F.A.T. WRENCH®

FIREARM ACCURIZING TORQUE

PRODUCT: 553556

UPC: 661 120535560

- BITS ARE MADE FROM S2 TOOL STEEL AND HARDENED TO 56-58 ROCKWELL "C"
- TORQUE ADJUSTMENT RANGE FROM 10 IN/LBS TO 65 IN/LBS
- ACCURACY PLUS/MINUS 2 IN/LBS UP TO 40 IN/LBS; 40-65 IS +/- 5%

The Wheeler® F.A.T. Wrench® (Firearm Accurizing Torque) brings perfect consistency to every screw on your rifle. This amazing, handheld torque wrench lets you apply repeatable, accurate torque settings to scope bases and rings, action screws, and more. This prevents damage to optics and firearms, and decreases the chances of failure in the field. The large range of 10-65 in/lbs. will aid in accurately torquing screws to recommended specifications. The F.A.T. Wrench includes 10 bits built to last, made from S2 tool steel hardened to 56-58 Rockwell C. The included custom-molded case is perfect for storing the wrench and bits when not in use.



DIGITAL F.A.T. WRENCH®

FIREARM ACCURIZING TORQUE

PRODUCT: 710909

UPC: 661120109099

- BITS ARE MADE FROM S2 TOOL STEEL AND HARDENED TO 56-58 ROCKWELL C
- ERGONOMIC OVER MOLDED DESIGN
- LARGE LCD DIGITAL DISPLAY FOR EASE OF VIEWING
- AUDIBLE INDICATOR TONE
- FULL SET OF BITS INCLUDED

The Wheeler® Digital F.A.T. Wrench® (Firearm Accurizing Torque) brings precise torque settings to the handheld torque wrench market. This digital handheld torque wrench lets you apply repeatable, accurate torque settings to scope bases and rings, action screws, and more. The audible and visual indicators let the user know exactly when the desired torque setting has been achieved. The large range of 15-100 in/lbs. will aid in accurately torqueing screws to recommended specifications. The Digital F.A.T. Wrench includes 10 bits built to last, made from S2 tool steel hardened to 56-58 Rockwell C. The included custom-molded case is perfect for storing the wrench and bits when not in use.



UNIVERSAL 1911/PISTOL BENCH BLOCK

PRODUCT: 672215

UPC: 661120188278

- MAIN SPRING REMOVAL RECESS AND BOSS
- BARREL LINK REMOVAL V CHANNEL
- REAR SIGHT DRIFT CHANNEL AND FRONT SIGHT STAKING CHANNEL
- HAMMER AND SEAR PIN REMOVAL HOLES
- EJECTOR PORT DRESSING CHANNEL

Made of non-marring urethane, the Wheeler® Universal 1911/Pistol Bench Block is perfect for use on M1911 pistols as well as other firearms such as 10/22s.





ARMORER'S HANDGUN SIGHT TOOL

PRODUCT: 710905

UPC: 661120109051

- FULLY CAPTURES AND SUPPORTS SLIDE
- SIGHT PRONG IS REVERSIBLE TO ACCOMMODATE GLOCKS
- WORKS ON ALL SEMI-AUTO PISTOLS
- LARGE 4-POST DRIVE KNOB TO EASILY PUSH THE SIGHT

The Wheeler® Armorer's Handgun Sight Tool is designed for adjusting, installing or removing dovetail style front and rear handgun sights. Made of high end materials, the Wheeler® Armorer's Handgun Sight Tool will last for years of use.





UNIVERSAL BARREL CLAMP

PRODUCT: 672286

UPC: 661120722861

- PRECISION EXTRUDED FROM AIRCRAFT GRADE ALUMINUM
- BONDED WITH NON-MARRING URETHANE

The Wheeler® Universal Barrel Clamp is precision extruded from aircraft grade aluminum and bonded with non-marring urethane. The urethane coating is specially designed to provide a protective layer for the barrel's finish while providing extraordinary gripping abilities. Three different barrel openings of .85", .66" and .53" will accommodate anything from an AR pencil barrel up to a bull barrel

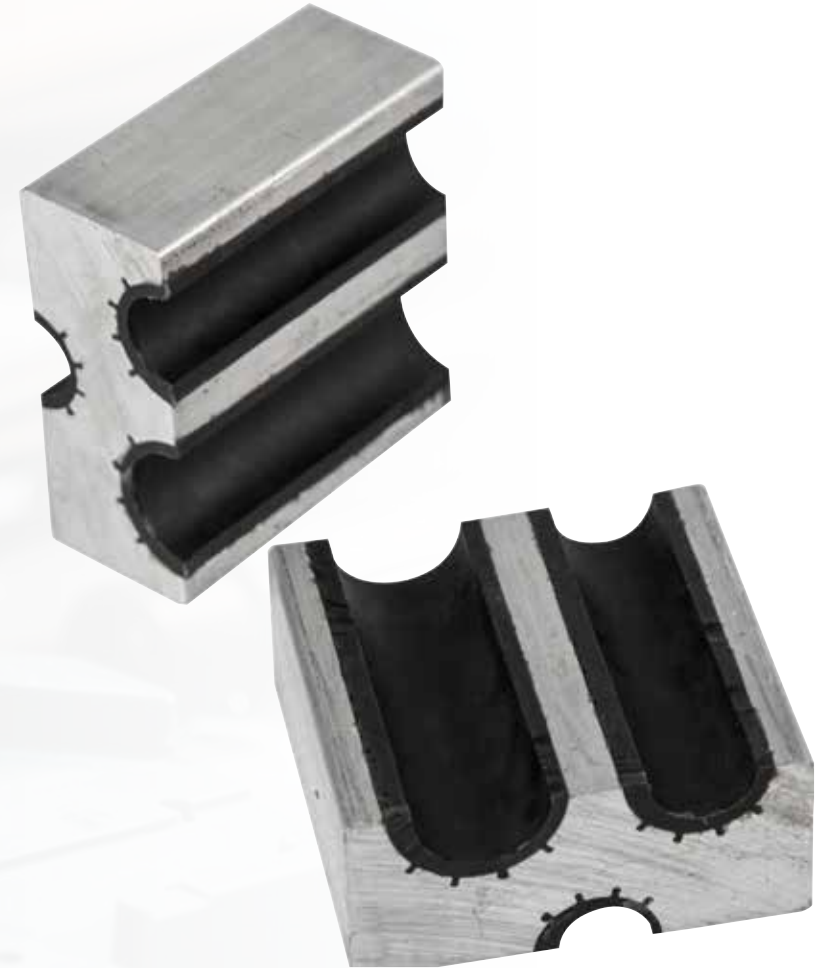



TRIGGER PULL GAUGE

PRODUCT: 309888

UPC: 661120098881

- ACCURATELY MEASURES TRIGGER PULL IN 2 OZ INCREMENTS
- ACCURATE TO +/- 2 OZ
- EASY-TO-READ SLIDING INDICATOR
- RANGE FROM 8 OZ. TO 8LBS

The Wheeler® Trigger Pull Scale accurately measures trigger pull weight from 8 ounces to 8 pounds. It features an ergonomically shaped handle for consistent direction of pull. Highly visible increment markings and easy to read sliding indicator that stays on the maximum weight registered.



PROFESSIONAL DIGITAL TRIGGER GAUGE

PRODUCT: 710904

UPC: 661120109044

- 0-12LBS RANGE WITH MIN, MAX, AVERAGE, AND LIVE FUNCTIONS
- LOAD SENSOR DIRECTLY CONTACTS THE TRIGGER
- ARM FOLDS INSIDE HOUSING TO PROTECT THE LOAD SENSOR WHEN NOT IN USE
- AUDIBLE INDICATOR TONE

The Wheeler® Professional Digital Trigger Gauge features an over-molded design for a consistent line of pull and soft-touch buttons for comfort. Includes bladed trigger adapter to allow use with triggers that have internal safety blades. Also includes a foam lined storage case.





PROFESSIONAL FILE SET

PRODUCT: 710908

UPC: 661120109082

KIT INCLUDES:

- 8" HALF ROUND FILE
- 8" FLAT FILE
- 6" SQUARE FILE
- 6" TRIANGLE FILE
- 6" ROUND FILE
- 4-IN-1 RASP
- FILE CLEANING BRUSH
- EXTRA-FINE DIAMOND PLATE
- STICK OF FILE CHALK
- FLAT COARSE GRIT FILE
- ROUND COARSE GRIT FILE
- TRIANGLE COARSE GRIT FILE
- FLAT MEDIUM GRIT FILE
- ROUND MEDIUM GRIT FILE
- TRIANGLE MEDIUM GRIT FILE
- FLAT LINE GRIT FILE
- ROUND FINE GRIT FILE
- TRIANGLE FINE GRIT FILE

The Wheeler® Professional Gunsmithing File Set is perfect for many different gunsmithing jobs. The set comes with a wide grade of files from a rough rasp all the way down to a super, extra fine diamond plate. All files fit neatly in roll-up case for storage.





BARREL VISE

WITH 3 OAK BUSHINGS

PRODUCT: 465185

UPC: 661120195177

- SECURELY CLAMP YOUR BARREL FOR REMOVAL OR INSTALLATION
- BARREL VISE INCLUDES TWO PRE-DRILLED OAK BLOCKS, 1" AND 3/4" AND A SOLID BLOCK FOR CUSTOM DRILLING

REPLACEMENT OAK BUSHINGS (3 PACK)

PRODUCT: 844879

UPC: 661120194712

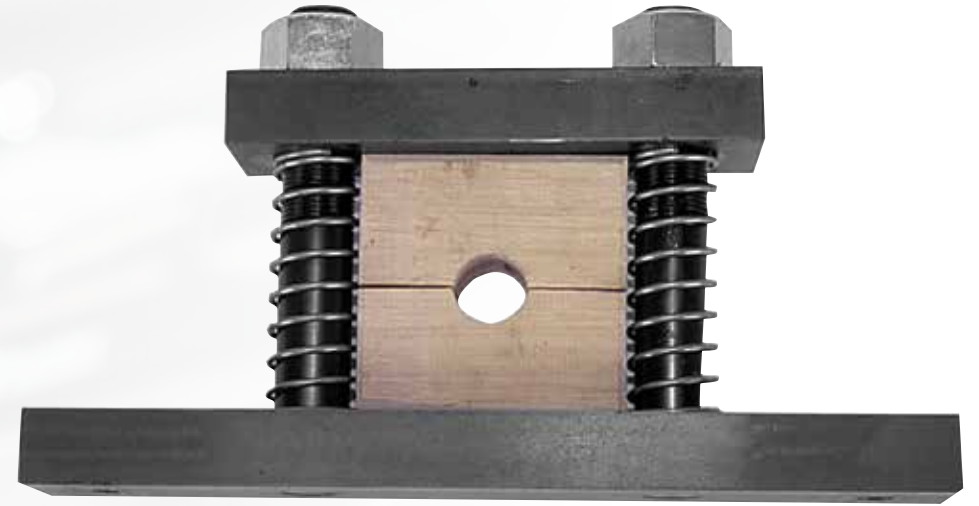

WHEELER

NYLON/BRASS HAMMER

PRODUCT: 711016

UPC: 661120110163

- NON-MARRING NYLON FACE
- BRASS FACE CAN BE USED FOR DRIVING PINS AND PUNCHES
- 11" LENGTH

The Wheeler® Nylon/Brass Hammer is likely to become your favorite hammer on the bench, or at the range. The nylon face is non-marring and is great for alignment and other uses where a steel hammer is not appropriate. The brass face can be used for driving pins and punches, as well as a multitude of other uses.





MASTER INTERCHANGEABLE HAMMER SET

PRODUCT: 110268

UPC: 661120001997

KIT INCLUDES:

- TWO MACHINED METAL HAMMER BODIES
- HAMMER FACES: METAL, BRASS, NYLON, RUBBER
- DURABLE BLOW -MOLDED CASE FOR STORAGE

The Wheeler® Master Interchangeable Hammer Set features two precision-machined hammer bodies. The large hammer is ideal for driving out large or stubborn pins. The small hammer is perfect when precise control is necessary. The set comes with 8 interchangeable hammer faces made from metal, brass, nylon, and rubber for a variety of jobs.





HAMMER PUNCH SET

PRODUCT: 951900

UPC: 661120519003

KIT INCLUDES:

- POLYMER AND BRASS HAMMER FACES
- EIGHT PRECISION BRASS PUNCHES
- FOUR STEEL PUNCHES
- TWO NON-MARRING POLYMER PUNCHES
- MOLDED STORAGE CASE

The Wheeler® Hammer Punch Set is a great tool for driving pins or drifting sights at the range or on your bench. Two hammer faces and a wide variety of punches allow for an assortment of jobs. Everything is neatly organized in the molded case for convenient storage.





MASTER ROLL PIN PUNCH SET

PRODUCT: 110128

UPC: 661120001409

KIT INCLUDES:

- 5/16"
- 3/16"
- 3/32"
- 1/4"
- 5/32"
- 5/64"
- 7/32"
- 1/8"
- 1/16"

The Wheeler® Master Roll Pin Punch Set combines two of our best pin sets with a gunsmithing hammer into one convenient kit. Counter-bored starter punches keep roll pins aligned for easy starting. The roll pin punches are designed with a hemispherical tip to provide proper alignment of the roll pin to prevent damage to the roll pin and firearm. All pins feature knurled handles for a secure hold when using.



BRASS PUNCH SET

PRODUCT: 780194

UPC: 661120801948

KIT INCLUDES:

- 5/16"
- 3/16"
- 3/32"
- 1/4"
- 5/32"
- 5/64"
- 7/32"
- 1/8"
- 1/16"

The Wheeler® Brass Punch Set features eight punches ranging in size from 1/8"-5/16". All punches are easily stored in the convenient roll-up pouch.





ROLL PIN STARTER SET

PRODUCT: 710910

UPC: 661120109105

KIT INCLUDES:

- 5/16"
- 3/16"
- 3/32"
- 1/4"
- 5/32"
- 5/64"
- 7/32"
- 1/8"
- 1/16"

The Wheeler® Roll Pin Starter Set are machined from hardened steel to prevent bending or breaking while starting any size roll pin. The punches are designed with a beveled tip for starting the roll pin.





ROLL PIN PUNCH SET

PRODUCT: 204513

UPC: 661120045137

KIT INCLUDES:

- 5/16"
- 3/16"
- 3/32"
- 1/4"
- 5/32"
- 5/64"
- 7/32"
- 1/8"
- 1/16"

The Wheeler® Roll Pin Punches are machined from hardened steel to prevent bending or breaking while driving any size roll pin. The punches are designed with a hemispherical tip to provide proper alignment of the roll pin to prevent damage to the roll pin and firearm. All punches are organized in the convenient roll-up pouch.



SAVAGE BARREL NUT WRENCH

PRODUCT: 123038

UPC: 661120230380

- FITS EARLY AND LATE MODEL NUTS ON THE 110 AND 10 SERIES RIFLES

The Wheeler® Savage Barrel Nut Wrench delivers the strength and rigidity required for proper barrel removal and installation. The action wrench safely surrounds and supports the receiver ring. The 15" long, 1" diameter steel handle will overcome even the tightest assemblies. The double ended savage barrel nut wrench fits both early and late model nuts on the 110 and 10 series rifles with both square or round notch barrel nuts. A second wrench is included for smooth barrel nuts with a non-marring brass shim. It also features two 1/2" square drive holes for a swing bar or a torque wrench.





ACTION WRENCH #1

MAUSER / FLAT BOTTOMED RECEIVER

PRODUCT: 808771

UPC: 661120195634

- SAFELY SURROUNDS AND SUPPORTS RECEIVER RING

Heavy duty tools to deliver the strength and rigidity required for proper barrel removal and installation. The Wheeler® Action Wrench wrench safely surrounds and supports the receiver ring. The 15" long, 1" diameter steel handle will overcome even the tightest assemblies.





ACTION WRENCH #2

REMINGTON 700

PRODUCT: 414521

UPC: 661120195405

- SAFELY SURROUNDS AND SUPPORTS RECEIVER RING

Heavy duty tools to deliver the strength and rigidity required for proper barrel removal and installation. The Wheeler® Action Wrench wrench safely surrounds and supports the receiver ring. The 15" long, 1" diameter steel handle will overcome even the tightest assemblies.





CERAMA COAT

CUSTOM GUN ARMOR

PRODUCT: 468993 **BLACK** UPC: 661120689935

PRODUCT: 492304 **FDE** UPC: 661120923046

PRODUCT: 567312 **OLIVE DRAB** UPC: 661120673125

- HIGHLY RESISTANT TO SCRATCHING, CHIPPING, AND GUN SOLVENTS
- WEATHERPROOF, MATTE FINISH
- BONDS TO FERROUS METALS, ALLOYS, STAINLESS STEEL AND SYNTHETICS THAT CAN BE HEATED TO 200 °F
- 4 OZ CAN

The Wheeler® Cerama-Coat is a specifically formulated finish that provides an extremely durable coating. The key to the super hard finish is ultra-fine ceramic molecules that crosslink and bond to the base material.





BEDROCK BEDDING KIT

PRODUCT: 190274

UPC: 661120902744

KIT INCLUDES:

- 4 OZ BEDROCK
- BROWN & BLACK DYE
- 2 FL OZ MICROBALLOONS
- MODELING CLAY
- SURGICAL TUBING
- 3 MIXING CUPS
- 3 MIXING/APPLICATOR STICKS
- RELEASE AGENT
- 2 RELEASE AGENT APPLICATORS

A rifle's accuracy is dependent on the fit of its barreled action to its stock. The Wheeler® Bedrock Bedding Kit makes your rifle's stock and metal components fit together to eliminate shift and pressure points caused by recoil and changes in temperature and humidity. Removing the contact points of the stock where the barreled action meets, and replacing them with Bedrock assures you of a perfect, stress-free fit.





LEAD BARREL VISE SHIMS (4 PACK)

PRODUCT: 239444

UPC: 661120194941

- INCLUDES 4 LEAD BARREL VISE SHIMS.
- SHIMS CAN BE REUSED MULTIPLE TIMES.

Wheeler® Vise Shims are recommended to line between barrel and vise bushings. It improves the grip of the firearm and won't damage steel or bluing.





RECOIL PAD INSTALLATION FIXTURE

PRODUCT: 184528

UPC: 661120845287

The Wheeler® Recoil Pad Installation Fixture accurately transfers the toe-line angle and the comb line from the stock to the new recoil pad; also serves as a stable work holding fixture for off-the-stock sanding of the pad. Designed for use with any table-mounted belt or disc sander. Rigid, cast aluminum base and aluminum pad mounting bar.





BOLT ACTION

SCOPE MOUNTS (1 PIECE)

FITS REMINGTON® MODEL 700® LONG ACTION

PRODUCT: 1110071	1" MED	UPC: 661120079347
PRODUCT: 1110072	1" HIGH	UPC: 661120079354
PRODUCT: 1108715	30MM MED	UPC: 661120079118
PRODUCT: 1108716	30MM HIGH	UPC: 661120079132
PRODUCT: 1108717	30MM EXTRA HIGH	UPC: 661120079149
PRODUCT: 1108718	34MM MED	UPC: 661120107859
PRODUCT: 1108719	34MM HIGH	UPC: 661120079156
PRODUCT: 1108720	34MM EXTRA HIGH	UPC: 661120079163

- FITS REMINGTON® MODEL 700® LA
- 6061 ALUMINUM CONSTRUCTION
- 6 HOLE RING DESIGN
- 20 MOA ELEVATION IN BASE
- FLIP-OUT ANTI-CANT INDICATOR
- AVAILABLE IN 1", 30MM, AND 34MM RING SIZES





BOLT ACTION

SCOPE MOUNTS (1 PIECE)

FITS REMINGTON® MODEL 700® SHORT ACTION

PRODUCT: 1110068	1" MED	UPC: 661120079323
PRODUCT: 1110069	1" HIGH	UPC: 661120079330
PRODUCT: 1108709	30MM MED	UPC: 661120078852
PRODUCT: 1108710	30MM HIGH	UPC: 661120078869
PRODUCT: 1108711	30MM EXTRA HIGH	UPC: 661120078876
PRODUCT: 1108712	34MM MED	UPC: 661120079088
PRODUCT: 1108713	34MM HIGH	UPC: 661120079095
PRODUCT: 1108714	34MM EXTRA HIGH	UPC: 661120079101

- FITS REMINGTON® MODEL 700® LA
- 6061 ALUMINUM CONSTRUCTION
- 6 HOLE RING DESIGN
- 20 MOA ELEVATION IN BASE
- FLIP-OUT ANTI-CANT INDICATOR
- AVAILABLE IN 1", 30MM, AND 34MM RING SIZES





BOLT ACTION

SCOPE MOUNTS (1 PIECE)

FITS SAVAGE® 10 SHORT ACTION

PRODUCT: 1110074	1" MED	UPC: 661120079361
PRODUCT: 1110075	1" HIGH	UPC: 661120079378
PRODUCT: 1108721	30MM MED	UPC: 661120079170
PRODUCT: 1108722	30MM HIGH	UPC: 661120079187
PRODUCT: 1108723	30MM EXTRA HIGH	UPC: 661120079194
PRODUCT: 1108724	34MM MED	UPC: 661120079200
PRODUCT: 1108725	34MM HIGH	UPC: 661120079217
PRODUCT: 1108726	34MM EXTRA HIGH	UPC: 661120079224

- FITS SAVAGE® 10
- 6061 ALUMINUM CONSTRUCTION
- 6 HOLE RING DESIGN
- 20 MOA ELEVATION IN BASE
- FLIP-OUT ANTI-CANT INDICATOR
- AVAILABLE IN 1", 30MM, AND 34MM RING SIZES





BOLT ACTION

SCOPE MOUNTS (1 PIECE)

FITS SAVAGE® 110 LONG ACTION

PRODUCT: 1110077	1" MED	UPC: 661120079385
PRODUCT: 1110078	1" HIGH	UPC: 661120079392
PRODUCT: 1108727	30MM MED	UPC: 661120079231
PRODUCT: 1108728	30MM HIGH	UPC: 661120079248
PRODUCT: 1108729	30MM EXTRA HIGH	UPC: 661120079255
PRODUCT: 1108730	34MM MED	UPC: 661120079262
PRODUCT: 1108731	34MM HIGH	UPC: 661120079279
PRODUCT: 1108732	34MM EXTRA HIGH	UPC: 661120079286

- FITS SAVAGE® 110
- 6061 ALUMINUM CONSTRUCTION
- 6 HOLE RING DESIGN
- 20 MOA ELEVATION IN BASE
- FLIP-OUT ANTI-CANT INDICATOR
- AVAILABLE IN 1", 30MM, AND 34MM RING SIZES





CANTILEVER SCOPE MOUNTS (1 PIECE)

PRODUCT: 1110077 **1"** UPC: 661120417224

PRODUCT: 1110078 **30MM** UPC: 661120417231

PRODUCT: 1108727 **34MM** UPC: 661120418863

- 2" CANTILEVER EXTENSION
- HARDWARE INCLUDED (TORX SCREWS)
- 6 HOLE RING DESIGN
- RETAINED 1/2" LOCK NUTS SECURE TO PIC RAIL
- FLIP-OUT ANTI-CANT INDICATOR

Get the perfect mount with Wheeler® 1 Piece Bolt Action Scope Mounts. Made of 6061 aluminum, the 6 hole ring design features a swing-out anti-cant indicator. Designed to fit on any AR or Precision Rifle with a Pic Rail, these 1 piece scope mounts are available in 1", 30mm, and 34mm ring sizes.





PICATINNY

SCOPE MOUNTS (1 PIECE)

PRODUCT: 1099951 **34MM LOW** UPC: 661120417989

PRODUCT: 1099947 **34MM MED** UPC: 661120417996

PRODUCT: 1100186 **34MM HIGH** UPC: 661120417972

PRODUCT: 1099954 **30MM LOW** UPC: 661120417255

PRODUCT: 1099955 **30MM MED** UPC: 661120417262

PRODUCT: 1099956 **30MM HIGH** UPC: 661120417248

PRODUCT: 1099904 **1" LOW** UPC: 661120417200

PRODUCT: 1099907 **1" MED** UPC: 661120417217

PRODUCT: 1099903 **1" HIGH** UPC: 661120417194

- 6061 ALUMINUM CONSTRUCTION
- HARDWARE INCLUDED (TORX SCREWS)
- 6 HOLE RING DESIGN
- RETAINED 1/2" LOCK NUTS SECURE TO PIC RAIL
- FLIP-OUT ANTI-CANT INDICATOR





ANTI-CANT INDICATOR

PRODUCT: 755712 **1"** UPC: 661120557128

PRODUCT: 766112 **30MM** UPC: 661120661122

PRODUCT: 580033 **PIC RAIL** UPC: 661120800330

- INDICATES PRECISE, REPEATABLE LEVEL GUN POSITION
- EASY-TO-VIEW FROM SHOOTING POSITION
- FOLDS IN WHEN NOT IN USE
- ATTACHES VIA UNIVERSAL PICATINNY RAIL ATTACHMENT OR DIRECTLY TO SCOPE
- PRECISION MACHINED ALUMINUM WITH ANODIZED FINISH

Keeping your scope perfectly aligned is critical to long-range accuracy. Canting your scope, even just a couple of degrees, can cause error in point of impact. With modern "Drop-Compensating" scopes, The Wheeler® Anti-Cant Indicator is a necessity.

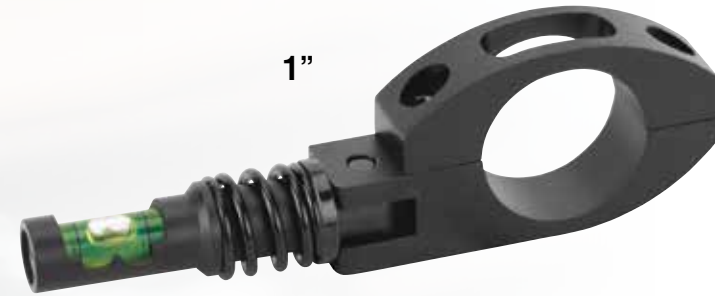

1"



30MM



PIC RAIL

PROFESSIONAL SCOPE MOUNTING KITS

PRODUCT: 540127 1" UPC: 661120401278

PRODUCT: 545454 1" & 30MM UPC: 661120454540

KIT INCLUDES:

- F.A.T. WRENCH
- 10 BITS
- 1/2 SOCKET
- LEVEL-LEVEL-LEVEL
- FLEX DRIVER
- LAPPING BAR(S)
- ALIGNMENT BARS
- LAPPING BAR HANDLE
- LAPPING COMPOUND
- THREAD LOCKER
- STORAGE CASE

The Wheeler® Professional Scope Mounting Kit will properly align, attach and level your scope on your gun. Alignment and lapping bars make ring alignment simple and easy. The Level-Level-Level provides precise leveling for your scope and the F.A.T. Wrench® guarantees exact torque specs on your scope rings. A flex driver is included for use with a power drill.





ULTRA SCOPE MOUNTING KIT

PRODUCT: 541010

UPC: 661120410102

KIT INCLUDES:

- F.A.T. WRENCH
- LENS PEN
- THREAD LOCKER
- HEAVY-DUTY STORAGE CASE WITH FOAM-MOLDED INSERTS
- PROFESSIONAL RETICLE LEVELING SYSTEM
- 10 BITS AND ONE SOCKET WITH BIT HOLDER
- GREEN PROFESSIONAL LASER BORE SIGHTER

The Wheeler® Ultra Scope Mounting Kit puts all the best scope mounting accessories into one perfect package. With this kit you can level your rifle and scope, mount your scope to the rifle, and bore sight your scope with precision and accuracy. The Ultra Scope Mounting Kit even provides a lens pen and thread locker to keep your scope clean and your optics secure on even the largest caliber guns. Includes a heavy duty carry case to keep components organized and secured.



LEVEL-LEVEL-LEVEL

PRODUCT: 113088

UPC: 661120130888

- FEATURES TWO LEVELS TO CALIBRATE THE SCOPE TO THE GUN
- SCOPE TURRET LEVEL SITS ON TOP OF SCOPE TURRET
- ACTION LEVEL MAGNETICALLY ATTACHES TO GUN'S ACTION

The Wheeler® Level-Level-Level works by leveling the scope to the receiver, not to the top of a scope base. This scope mounting level works with practically any bolt-action rifle and is adaptable to other designs as well.



Action Level
(magnetized)



PROFESSIONAL RETICLE LEVELING SYSTEM

PRODUCT: 119050

UPC: 661120190509

KIT INCLUDES:

- TWO CALIBRATED MACHINED ALUMINUM LEVEL HOUSINGS
- FOAM-MOLDED STORAGE CASE

The Wheeler® Professional Reticle Leveling System (PRLS) is a precision tool designed to allow a scope to be perfectly leveled on any firearm with ease by leveling the scope to the gun itself. The adjustable Barrel Clamp Level fits around even the largest diameter barrels (including shotguns) and features non-marring pads to prevent damage. The Reference Level has a magnetic bottom to ensure stability.



Reference Level



Barrel Clamp Level



Action Level
(magnetized)



PROFESSIONAL LASER

BORE SIGHTER

PRODUCT: 580022 **RED LASER** UPC: 661120800224

PRODUCT: 589922 **GREEN LASER** UPC: 661120899228

KIT INCLUDES:

- PLASTIC STORAGE CASE
- LITHIUM 123A BATTERY
- REFLECTIVE SIGHTING GRID

The Wheeler® Professional Laser Bore Sighter uses a high-power laser and a high-strength magnetic connection to the barrel to deliver fast accurate bore sighting. This system works with virtually all firearms; rifles, shotguns, handguns. The Machined aluminum housing is factory calibrated with the laser for extreme accuracy.

