

# Pioneers of Success

**Including Lead-Free Ammunition Programme**

Ammunition for Successful Expert Hunting  
*Rifle Ammunition · Slug Ammunition · Bullets for Reloaders*

  
ORIGINAL  
**BRENNEKE**®  
THE ART OF AMMUNITION

# Best Practice

Let's get straight to the point.

*A pioneer's experience is priceless. Yet, BRENNEKE hunting ammunition – rifle as well as slug – is renowned for its excellent price-performance ratio. We are proud to offer you true German craftsmanship – because 119 years after the invention of the shotgun bullet our focus is still on quality and precision. There is no question about it, if you are looking for original expert hunting ammunition, the answer is simply: BRENNEKE.*



Hunting Success with BRENNEKE Hunting Ammunition

2 – 9

Rifle ammunition

TIG – Torpedo Ideal Bullet	10 – 11
TUG – Torpedo Universal Bullet	12 – 13
TOG – Torpedo Optimal Bullet	14 – 15
BASIC   Soft-Point-Bullet	16 – 17

Lead-free BRENNEKE hunting ammunition	18 – 19
TUG nature – Lead-free TUG Bullet	20 – 21
TAG – Torpedo Alternative Bullet	22 – 23

Rifle cartridges

Making the right choice	24
Calibre group .243	25 – 26
Calibre group 7mm	27 – 34
Calibre group .30	36 – 45
Ammunition overview (centre of brochure)	40 – 41
Calibre group 8mm S	46 – 51
Calibre group 9,3mm	52 – 56
Calibre group .375	57

Bullets for reloaders

58 – 59

Slug ammunition

Hunting success with BRENNEKE slugs	60 – 63
Slugs for hunting	64 – 73
Slugs for sport shooting	74 – 75
Slugs for law enforcement	76 – 77

Weapon care

78 – 79

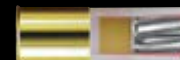

# At the Heart



Condensed power  
hitting the mark.



*Good tools are essential for success. Hence, expert hunting and high-performance ammunition belong together. BRENNKE links both: enormous knockdown power and best possible game preservation. Its sharp cutting edge and outstanding penetration efficiency ensure stalking signs and exit wound.*

ORIGINAL  
**BRENNEKE**<sup>®</sup>

# Strong Impact

Your great pride.  
Our small contribution.

*Complete success! No messing around; you brought the game down following the best hunting principles. Due to its highly reliable terminal ballistics your BRENEKE rifle ammunition has released maximum energy into the game's body unfolding its stopping power at lightning speed. Absolutely safe and accurate. For proud trophies.*

ORIGINAL  
**BRENEKE**<sup>®</sup>



Wilhelm Brenneke,  
(1865–1951)  
Founder of the  
company and  
inventor of the  
accurate hunting  
round.



1905

2014

# Always At The Top

## Hunting Pioneers since 1895.

*BRENNEKE is renowned for groundbreaking innovations in the hunting business: from the first slug to the latest in universal rifle ammunition. Corporate history and family tradition are closely intertwined. The further development of precision hunting ammunition is our personal privilege and responsibility. We are known for true innovative drive made in Germany. We love to share our wealth of experience with you and turn it into your professional hunting success. Generation after generation.*

## Trendsetting BRENNEKE Developments and Inventions

- 1895 Company Foundation
- 1898 First Slug
- 1905 Ideal Bullet
- 1912 cal. 8x64
- 1917 cal. 7x64/7x65 R BRENNEKE
- 1919 TIG
- 1927 cal. 9,3x64 BRENNEKE
- 1930 Sharp Cutting Edge
- 1935 TUG
- 2001 RubinSabot, SuperSabot
- 2003 TOG
- 2007 TAG (lead-free)
- 2009 TIG nature (lead-free)
- 2010 TUG nature (lead-free)
- 2012 RubinSabot nature (lead-free)
- 2012 Basic
- 2014 TUG nature+
- 2016 Anti Terror Slug
- 2017 Soft-Point-Bullet

## Company history

- March 30, 1865 Wilhelm Brenneke born in Hanover, Germany.
- April 1, 1895 Foundation of the „Wilhelm Brenneke rifle and bullet factory“ in Leipzig, Germany.
- 1897-1935 Invention of the modern hunting ammunition for rifles and shotguns by Wilhelm Brenneke
- 1943-1974 Company run by Elsa Brenneke (daughter of the company's founder)
- 1951 Company moved to West Berlin
- 1971 Company moved to Langenhagen, Germany (current location of company headquarters)
- 1974-1980 Company run by Waltraud Mank (granddaughter of the company's founder)
- September 1, 1978 Company split into holding company and operating company
- Since 1980 Company run by Dr Peter Mank (great-grandson of Wilhelm Brenneke)
- Since 1985 Further development and new development of shotgun slugs (precision and use up to 100 m)
- 1995 Formation of BRENNEKE OF AMERICA, L.P. and 100th company anniversary
- Since 2003 Expansion of our own rifle cartridge range with TIG, TUG, TOG, TAG and TUG nature+
- 2015 150th birthday of Wilhelm Brenneke and 120th company anniversary





Perfect precision in every barrel.

As accurate as it gets. Day after day. Since 1919.

*Renowned for its outstanding penetration this is a classic for hunting young boars and roe deer. Day after day, TIG® proves to be one of the most successful bullets for all light and moderately heavy types of game on a worldwide scale.*

*The design of the TIG® causes a mushroom-like deformation of the harder rear core, along with a maximum release of energy facilitated by the copper/nickel-plated jacket. In addition, the jacket provides optimal penetration and utmost precision.*

## Torpedo Ideal Bullet



Available calibres  
7 mm (11,5 g / 181 grs)  
.30 (9,7 g / 150 grs) **NEW**  
8 mm S (12,8 g / 198 grs)

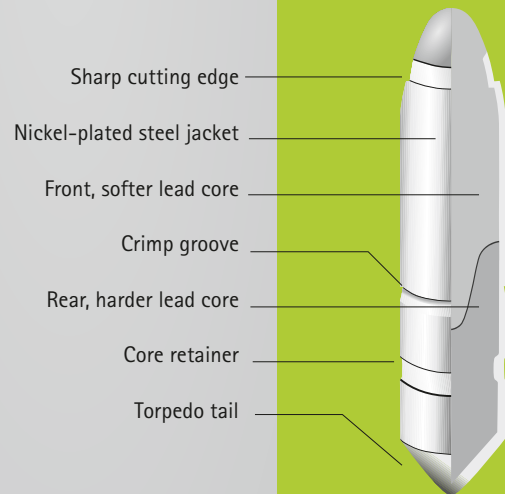



Uncompromising  
stopping power.

First choice for heavy game.  
Over more than 80 years.

*High penetration power is the result of the small mushrooming disposition these binuclear partial fragmentation projectiles are designed for. Hunters worldwide count on the accurate exit wound when shooting moderately heavy up to heavy types of game such as stag or buffalo.*

## Torpedo Universal Bullet



Available calibres  
.30 (11,7 g / 181 grs)  
9,3mm (19,0 g / 293 grs)

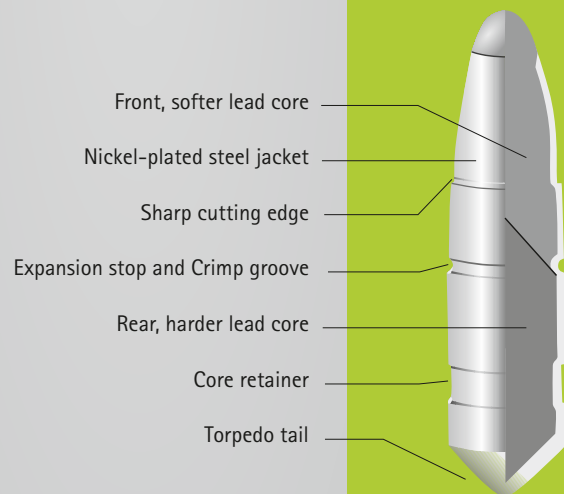



Heavy Duty.  
Serious business  
for big game.

*A worthwhile investment: The strong jacket construction of the TOG® controlled-expansion bullet results in mushrooming without releasing mass. Hunters all over the world benefit from its highly accurate long-range shooting properties – for all heavy game.*

## Torpedo Optimal Bullet



Available calibres  
6 mm / .243 (6,2 g / 96 grs),  
7 mm (9,7 g / 150 grs),  
.30 (10,7 g / 165 grs),  
8 mm S (11,7g / 181 grs und  
14,2 g / 220 grs),  
9,3 mm (16,0 g / 247 grs),  
.375 (17,5 g / 270 grs) und  
10,3 mm (15,2 g / 235 grs).

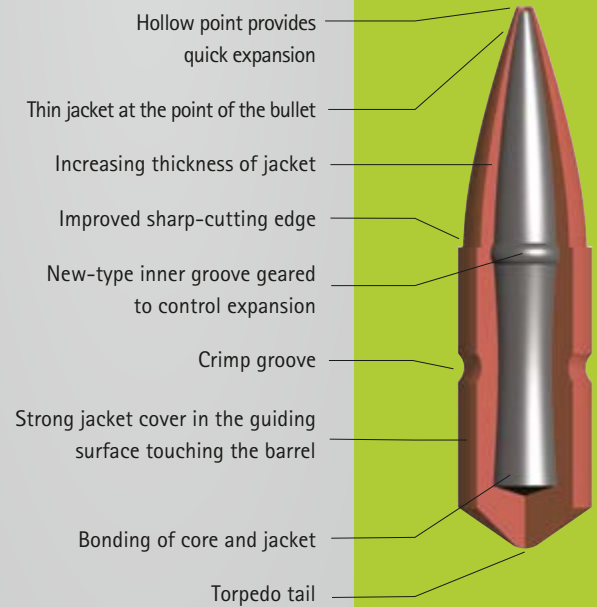



# BRENNEKE BASIC

## BRENNEKE BASIC

Available calibres  
.30 (12,0 g / 185 grs)  
8 mm S (13,0 g / 200 grs)

Advanced precision  
at a starter price.

Go original. It'll always be  
your best choice.

*You are looking for affordable, fast and reliable bullets? Our new BASIC partial fragmentation projectiles with tombac jacket and special lead alloy own everything an original BRENNEKE stands for – including the sharp cutting edge for cut hair at the entry wound. It performs with absolute reliability when used for light and moderately heavy game up to 50 kilograms.*

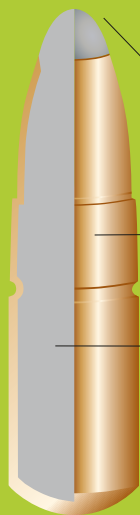
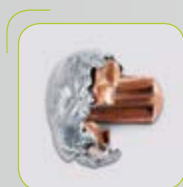

Open lead point  
Sharp cutting edge  
Tombac jacket  
Improved crimp groove  
Improved lead alloy

The soft-point  
deformation bullet.

Both simple and  
inexpensive.

*The soft-point-bullet has very high energy transfer to the body of the game thanks to the special bullet design which, in turn, guarantees a good stopping effect. The soft-point bullets complement the BASIC bullets as an entry-level model in calibres .270 Win., 7x64, 7x65R, and 7 mm Rem. Mag.*



Sharp cutting edge  
Improved crimp groove  
Improved lead alloy  
Torpedo tail



# BRENNEKE TEILMANTEL

## BRENNEKE TEILMANTEL

Available calibres  
.270 (8,4 g / 130 grs) **NEW**  
Sierra Gameking  
7 mm (9,4 g / 145 grs) **NEW**  
Orig. BRENNEKE Teilmantel  
Soft-Point-Bullet



# Lead-Free

Simply the best.  
Benefit from great advantages.

*Everyone knows: Game is a healthy alternative to raised meat. However, toxic heavy metals from ammunition containing lead might pose a health hazard if they get into our food chain.*

*Some hunters may think lead-free ammunition is nothing more than a costly commitment. However, experience has taught us that it is a worthwhile investment. Lead-free game is a sought-after source of quality meat that consumers are willing to pay more for.*

*Does the call for lead-free ammunition trigger hysteria? As a matter of fact, lead-free ammunition is obligatory in FSC-certified forestry. More and more masters of the hunt are in favour of it and it is reasonable to presume that according laws will follow.*

*Whether your decision is driven by responsibility, revenue or regulations, BRENNEKE is your partner for lead-free ammunition. As pioneers of hunting ammunition, we are dedicated to providing you with high performance tin and copper bullets of proven quality.*





Topped point  
lead-free bullets.

The fastest way to cut  
hair, blood and exit  
wound.

*Trust the expert in immediate  
energy transmission. Topped  
points guarantee absolutely  
reliable stopping power,  
maximum game preser-  
vation and hardly  
any  
haematomes.*

## Torpedo Universal Bullet nature +



Available calibres  
7mm (8,3g / 128 grs)  
.30 (9,5 g / 147 grs)  
8mm S (9,7 g / 150 grs)  
9,3mm (14,2g / 220 grs)

Lead-Free

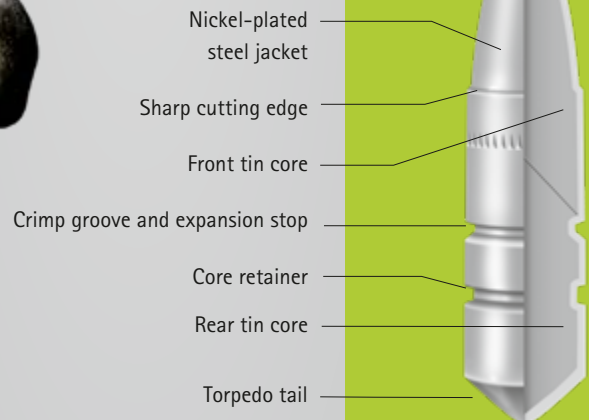



# Torpedo Alternativ Bullet

Lead-Free



Available calibres  
 6,5mm (8,4g / 130 grs) **NEW**  
 .270 (8,4 g / 130 grs) **NEW**  
 7mm (10,4g / 160 grs) **NEW**  
 .30 (10,0 g / 155 grs)  
 8mm S (11,3 g / 175 grs)  
 9,3mm (14,6 g / 225 grs)

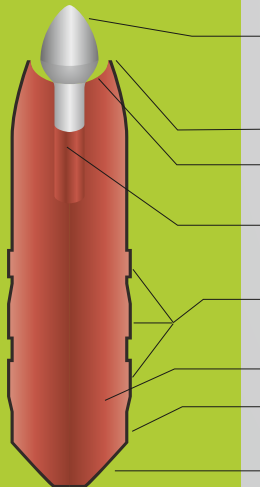

- Aluminium point for optimal exterior ballistics and fast start of fragmentation
- Sharp cutting edge
- Three grooved breaking points for guiding the fragmentation
- Hollow point for optimal fragmentation
- Optimized guide flanks for maximum precision
- High-purity copper
- Anti friction coating for perfect interior ballistics
- Torpedo tail



A bold move  
 Our drive hunt expert  
 with immediate stopping  
 power.

*It excels with exceptional performance due to its ultimate shock effect. Your choice for universal use: TAG®, the lead-free BRENNEKE partial fragmentation projectile made from high-purity copper.*

Check the advantages of an original BRENNEKE TAG® construction:

1. TAG® aluminium point for ideal exterior ballistics and immediate fragmentation of the front part of the bullet – suitable for almost any game and distance.
2. Three grooved breaking points provide controlled fragmentation and achieve immediate stopping power.
3. Rear portion of bullet causes substantial exit wound without jeopardizing the immediate area behind the game.
4. BRENNEKE sharp cutting edge causes a substantial exit wound with cut hair and blood.
5. High-purity copper bullet with anti-friction coating guarantees perfect interior ballistics. Optimized guide flanks assure maximum precision as well as low wear and tear of the barrel.



*Great results in practical tests*

<i>Average flight distance:</i>	<i>20,8 m (0 – 67 m)</i>
<i>Average game weigh:</i>	<i>22,1 kg (2 – 101 kg)</i>
<i>Average shooting distance:</i>	<i>64,6 m (6 – 154 m)</i>
<i>Likelihood of exit wound:</i>	<i>97,4 %</i>

Visit us at [www.brenneke.com](http://www.brenneke.com) and learn more about loading and reloading data, ballistics and weapon technologies, active hunting with various bullets and much more.

Would you like some personal advice?

We are here for you!

Give us a call: +49 511 972 62-0

Email us: [info@brenneke.com](mailto:info@brenneke.com)

# Info

## Sought. Found. Satisfied.

Ask your specialized dealer for BRENNEKE bullets. Do not settle for anything less than the original. Since 1895, generations of hunters have trusted in our highest quality standards to feel the pride of pioneering success. It is your turn now!

Find your calibre by simply following the colour code:

- **Calibre group 6 mm / 6,5 mm**  
 . 243 Win.; 6,5x55; 6,5x57 und 6,5x57 R
- **Calibre group 7 mm/ .270**  
 .270 Win., 7x57; 7x57 R; 7x64 BRENNEKE;  
 7x65 R BRENNEKE ; 7mm Rem. Mag.
- **Calibre group .30**  
 .308 Win.; .30-06; .30R Blaser; .300 Win. Mag.
- **Calibre group 8 mm S**  
 8x57 JS; 8x57 JRS; 8x64 S BRENNEKE; 8x68 S
- **Calibre group 9,3 mm**  
 9,3x62; 9,3x64 BRENNEKE; 9,3x74 R
- **Calibre group .375**  
 .375 H&H Mag.

# .243 Win.



.243 Win.  
6,2 g / 96 grs

BRENNEKE  
**TOG**



Distance	0	100	150	200	300
Velocity (m/s)	940	835	785	737	647
Energy (J)	2.721	2.147	1.899	1.675	1.288
• 100m (cm)	-5,0	0,0	-2,6	-9,1	-36,4
MRD • 188m (cm)	-5,0	+3,8	+3,1	-1,5	-25,0

20 units per package (Art.-Nr. 031936)



ORIGINAL  
**BRENNEKE**

# 6,5 x 55 / 57 / 57 R

# .270 Win.



6,5 x 55 SE  
8,4 g / 130 grs



NEW

Distance		0	100	150	200	300
Velocity	(m/s)	852	739	682	627	526
Energy	(J)	3.049	2.295	1.956	1.652	1.160
+100 m	(cm)	-5,0	0,0	-4,0	-13,2	-51,6
MRD +146 m	(cm)	-5,0	+4,0	-0,4	-8,4	-44,4

20 units per package (Art.-Nr. 091047)

6,5 x 57  
8,4 g / 130 grs



NEW

Distance		0	100	150	200	300
Velocity	(m/s)	877	753	695	640	538
Energy	(J)	3.241	2.391	2.037	1.726	1.217
+100 m	(cm)	-5,0	0,0	-3,7	-12,5	-49,1
MRD +159 m	(cm)	-5,0	+4,0	+1,3	-10,3	-61,5

20 units per package (Art.-Nr. 091057)

6,5 x 57 R  
8,4 g / 130 grs



NEW

Distance		0	100	150	200	300
Velocity	(m/s)	849	727	671	617	517
Energy	(J)	3.035	2.229	1.895	1.601	1.124
+100 m	(cm)	-5,0	0,0	-4,2	-13,8	-53,8
MRD +155 m	(cm)	-5,0	+4,0	+0,8	-8,0	-35,2

20 units per package (Art.-Nr. 091067)

.270 Win.  
8,4 g / 130 grs



NEW

Distance		0	100	150	200	300
Velocity	(m/s)	920	789	728	670	561
Energy	(J)	3.619	2.730	2.357	2.025	1.470
+100 m	(cm)	-5,0	0,0	-3,1	-10,9	-43,6
MRD +188 m	(cm)	-5,0	+4,0	+1,8	-5,8	-30,3

20 units per package (Art.-Nr. 091837)

.270 Win.  
8,4 g / 130 grs



NEW

Distance		0	100	150	200	300
Velocity	(m/s)	927	837	795	755	683
Energy	(J)	3.548	2.954	2.665	2.405	1.964
+100 m	(cm)	-5,0	0,0	-2,6	-9,0	-35,3
MRD +188 m	(cm)	-5,0	3,9	3,2	-1,4	-24,0

20 units per package (Art.-Nr. 080838)





# 7x57



7x57  
11,5 g / 177 grs



Distance	0	100	150	200	300
Velocity (m/s)	760	681	644	607	538
Energy (J)	3.321	2.668	2.381	2.120	1.665
+100 m (cm)	-5,0	0	-5,2	-16,1	-59,1
MRD +157 m (cm)	-5,0	+4,0	+0,8	-8,2	-47,2

20 units per package (Art.-Nr. 050935)

# 7x57 R



7x57 R  
11,5 g / 177 grs



Distance	0	100	150	200	300
Velocity (m/s)	750	672	635	598	530
Energy (J)	3.234	2.597	2.319	2.056	1.615
+100 m (cm)	-5,0	0	-5,4	-16,8	-61,3
MRD +155 m (cm)	-5,0	+4,0	+0,7	-8,8	-49,2

20 units per package (Art.-Nr. 051035)

7x57  
10,4 g / 160 grs



Lead-free

NEW

Distance	0	100	150	200	300
Velocity (m/s)	775	651	596	546	460
Energy (J)	3123	2201	1846	1552	1100
+100 m (cm)	-5,0	0,0	-4,6	-17,9	-67,7
MRD +159 m (cm)	-5,0	+4,0	+1,3	-10,0	-55,8

20 units per package (Art.-Nr. 091017)

7x57 R  
10,4 g / 160 grs



Lead-free

NEW

Distance	0	100	150	200	300
Velocity (m/s)	753	632	579	531	447
Energy (J)	2948	2077	1743	1467	1039
+100 m (cm)	-5,0	0,0	-5,1	-19,5	-72,7
MRD +156 m (cm)	-5,0	+4,0	+0,9	-11,5	-60,9

20 units per package (Art.-Nr. 091027)

7x57 R  
9,7 g / 150 grs



Distance	0	100	150	200	300
Velocity (m/s)	800	731	698	666	605
Energy (J)	3.111	2.600	2.371	2.158	1.777
+100 m (cm)	-5,0	0	-4,2	-13,5	-48,8
MRD +167 m (cm)	-5,0	+4,0	+1,9	-5,4	-36,7

20 units per package (Art.-Nr. 031236)



# 7 x 64 BRENNEKE



7 x 64  
11,5 g / 177 grs

**TOG**  
BRENNEKE



Distance		0	100	150	200	300
Velocity (m/s)		830	747	708	669	596
Energy (J)		3.961	3.210	2.879	2.575	2.042
+100 m (cm)		-5,0	0,0	-3,9	-12,6	-47,3
MRD +170 m (cm)		-5,0	+4,0	+2,1	-4,7	-35,3

20 units per package (Art.-Nr. 050135)

7 x 64  
8,3 g / 128 grs

**TOG**  
BRENNEKE  
nature



Distance		0	100	150	200	300
Velocity (m/s)		930	764	688	616	487
Energy (J)		3.589	2.419	1.962	1.574	985
+100 m (cm)		-5,0	0,0	-3,4	-12,0	-49,9
MRD +174 m (cm)		-5,0	+3,9	+2,4	-4,3	-38,8

20 units per package (Art.-Nr. 060336)

7 x 64  
9,7 g / 150 grs

**BRENNEKE**  
**TOG**



Distance		0	100	150	200	300
Velocity (m/s)		885	812	777	742	676
Energy (J)		3.789	3.198	2.928	2.670	2.216
+100 m (cm)		-5,0	0	-2,9	-9,7	-37,5
MRD +185 m (cm)		-5,0	+3,9	+3,0	-1,9	-25,7

20 units per package (Art.-Nr. 032336)



# 7 x 64 BRENNEKE



7 x 64  
10,4 g / 160 grs

**BRENNEKE**  
**TAG**



**NEW**

Distance		0	100	150	200	300
Velocity (m/s)		850	712	653	598	503
Energy (J)		3757	2640	2215	1857	1316
+100 m (cm)		-5,0	0,0	-3,6	-14,6	-55,3
MRD +185 m (cm)		-5,0	+3,9	+2,1	-6,9	-43,7

20 units per package (Art.-Nr. 091007)

7 x 64  
9,4 g / 145 grs

**BRENNEKE**  
**TEILMANTEL**



**NEW**

Distance		0	100	150	200	300
Velocity (m/s)		897	810	769	729	652
Energy (J)		3.796	3.095	2.787	2.502	2.002
+100 m (cm)		-5,0	0,0	-2,9	-9,9	-38,5
MRD +186 m (cm)		-5,0	+4,0	+2,8	-1,8	-28,5

20 units per package (Art.-Nr. 080738)



# 7 x 65 R BRENNEKE



7 x 65 R  
11,5 g / 177 grs



Distance		0	100	150	200	300
Velocity	(m/s)	820	738	698	660	587
Energy	(J)	3.866	3.132	2.801	2.505	1.981
+100 m	(cm)	-5,0	0	-4,0	-13,1	-48,9
MRD +168 m	(cm)	-5,0	+4,0	+2,0	-5,1	-36,9

20 units per package (Art.-Nr. 050235)

7 x 65 R  
8,3 g / 128 grs



Distance		0	100	150	200	300
Velocity	(m/s)	880	719	646	577	455
Energy	(J)	3.214	2.147	1.731	1.381	858
+100 m	(cm)	-5,0	0,0	-4,2	-14,1	-57,9
MRD +165 m	(cm)	-5,0	+4,0	+1,8	-6,3	-46,7

20 units per package (Art.-Nr. 060337)

7 x 65 R  
9,7 g / 150 grs



Distance		0	100	150	200	300
Velocity	(m/s)	870	798	763	729	663
Energy	(J)	3.671	3.088	2.824	2.577	2.132
+100 m	(cm)	-5,0	0	-3,1	-10,2	-39,2
MRD +182 m	(cm)	-5,0	+3,9	+2,8	-2,4	-27,5

20 units per package (Art.-Nr. 032436)



# 7 x 65 R BRENNEKE



7 x 65 R  
10,4 g / 160 grs



NEW

Distance		0	100	150	200	300
Velocity	(m/s)	840	704	645	591	497
Energy	(J)	3669	2580	2165	1815	1286
+100 m	(cm)	-5,0	0,0	-4,0	-15,7	-57,5
MRD +185 m	(cm)	-5,0	+3,9	+1,8	-8,0	-45,7

20 units per package (Art.-Nr. 091737)

7 x 65 R  
9,4 g / 145 grs



NEW

Distance		0	100	150	200	300
Velocity	(m/s)	889	803	761	721	645
Energy	(J)	3.727	3.037	2.733	2.452	1.960
+100 m	(cm)	-5,0	0,0	-3,0	-10,2	-39,5
MRD +178 m	(cm)	-5,0	+4,0	+2,7	-1,9	-28,7

20 units per package (Art.-Nr. 050935)





# 7 mm Rem. Mag.



7 mm Rem. Mag.  
11,5 g / 177 grs



Distance		0	100	150	200	300
Velocity (m/s)		890	803	762	722	646
Energy (J)		4.555	3.708	3.339	2.997	2.400
+100m (cm)		-5,0	0	-3,0	-10,3	-39,5
MRD +183m (cm)		-5,0	+4,0	+3,0	-2,2	-27,4

20 units per package (Art.-Nr. 050335)

7 mm Rem. Mag.  
9,7 g / 150 grs



NEW

Distance		0	100	150	200	300
Velocity (m/s)		922	847	811	776	708
Energy (J)		4.129	3.485	3.196	2.926	2.439
+100 m (cm)		-5,0	0,0	-2,5	-8,8	-33,7
MRD +188 m (cm)		-5,0	+4,0	+1,8	-3,9	-26,6

20 units per package (Art.-Nr. 032936)

7 mm Rem. Mag.  
9,4 g / 145 grs



NEW

Distance		0	100	150	200	300
Velocity (m/s)		980	836	771	707	593
Energy (J)		4.514	3.289	2.792	2.355	1.653
+100 m (cm)		-5,0	0,0	-2,5	-9,1	-38,1
MRD +187 m (cm)		-5,0	3,8	3,2	-1,6	-27,0

20 units per package (Art.-Nr. 080938)



## Rifle Ammunition



# Meat Treat

Game is a valuable delicacy.  
We want you to get the most out of it.

*Saving on your ammunition means missing out on top quality of your feast.*

Improve your game quality with BRENNEKE. Indulge in excellent taste. Enjoy your meal with "Waidmannsheil"!

Game is among the best quality, most sustainable and eco-friendly food we have access to.

This is why we place great importance on first class bullet constructions. How can you benefit from it? It's simple: minimal mechanical destruction, contamination or haematoma formation.

Premium ammunition is a well worth investment.



ORIGINAL  
**BRENNEKE**

# .308 Win.



.308 Win.  
9,7 g / 150 grs



NEW

Distance	0	100	150	200	300
Velocity (m/s)	870	770	723	678	591
Energy (J)	3.671	2.876	2.535	2.229	1.694
+100 m (cm)	-5,0	0	-3,0	-11,0	-44,0
MRD +176 m (cm)	-5,0	+4,0	+2,6	-3,6	-32,7

20 units per package (Art.-Nr. 051135)

# .308 Win.



.308 Win.  
10,7 g / 165 grs



Distance	0	100	150	200	300
Velocity (m/s)	840	769	735	702	638
Energy (J)	3.775	3.164	2.889	2.633	2.175
+100 m (cm)	-5,0	0	-3,4	-11,5	-43,2
MRD +176 m (cm)	-5,0	+4,0	+2,6	-3,5	-31,3

20 units per package (Art.-Nr. 031536)

.308 Win.  
11,7 g / 181 grs



Distance	0	100	150	200	300
Velocity (m/s)	780	699	660	622	551
Energy (J)	3.559	2.858	2.548	2.263	1.776
+100 m (cm)	-5,0	0	-4,8	-15,2	-55,9
MRD +160 m (cm)	-5,0	+4,0	+1,3	-7,1	-43,8

20 units per package (Art.-Nr. 070135)

.308 Win.  
10,0 g / 155 grs



Distance	0	100	150	200	300
Velocity (m/s)	870	722	654	589	474
Energy (J)	3.785	2.606	2.138	1.736	1.123
+100 m (cm)	-5,0	0	-4,2	-14,0	-57,3
MRD +166 m (cm)	-5,0	+4,0	+1,8	-5,9	-45,2

20 units per package (Art.-Nr. 091037)

.308 Win.  
9,5 g / 147 grs



Bleifrei

Distance	0	100	150	200	300
Velocity (m/s)	857	732	673	617	514
Energy (J)	3.489	2.542	2.152	1.810	1.257
+100 m (cm)	-5,0	0,0	-4,0	-13,5	-53,1
MRD +167 m (cm)	-5,0	+4,0	+1,9	-5,6	-41,2

20 units per package (Art.-Nr. 060833)

.308 Win.  
12,0 g / 185 grs



Distance	0	100	150	200	300
Velocity (m/s)	778	701	664	629	561
Energy (J)	3.632	2.949	2.648	2.371	1.885
+100 m (cm)	-5,0	0	-4,8	-15,1	-54,7
MRD +160 m (cm)	-5,0	+4,0	+1,2	-7,1	-42,6

20 units per package (Art.-Nr. 080138)



# .30-06



.30-06  
9,7 g / 150 grs



NEW

Distance		0	100	150	200	300
Velocity (m/s)		910	807	759	712	623
Energy (J)		4.016	3.159	2.794	2.459	1.882
+100 m (cm)		-5,0	0	-2,0	-10,0	-39,0
MRD +184 m (cm)		-5,0	+4,0	+3,1	-2,1	-27,8

20 units per package (Art.-Nr. 051235)

.30-06  
11,7 g / 181 grs



Distance		0	100	150	200	300
Velocity (m/s)		840	755	715	675	600
Energy (J)		4.128	3.335	2.991	2.665	2.106
+100 m (cm)		-5,0	0	-3,7	-12,3	-46,2
MRD +172 m (cm)		-5,0	+4,0	+2,3	-4,2	-34,1

20 units per package (Art.-Nr. 070235)

.30-06  
9,5 g / 147 grs



nature



Lead-free

Distance		0	100	150	200	300
Velocity (m/s)		895	766	706	649	542
Energy (J)		3.805	2.788	2.368	2.000	1.398
+100 m (cm)		-5,0	0,0	-3,5	-11,9	-47,3
MRD +175 m (cm)		-5,0	+4,0	+2,5	-3,9	-35,3

20 units per package (Art.-Nr. 060434)



# .30-06



.30-06  
10,7 g / 165 grs



Distance		0	100	150	200	300
Velocity (m/s)		860	788	753	720	655
Energy (J)		3.953	3.320	3.035	2.769	2.292
+100 m (cm)		-5,0	0,0	-3,3	-10,8	-40,6
MRD +178 m (cm)		-5,0	+3,9	+2,6	-3,0	-28,8

20 units per package (Art.-Nr. 031436)

.30-06  
10,0 g / 155 grs



Lead-free

Distance		0	100	150	200	300
Velocity (m/s)		900	748	678	612	493
Energy (J)		4.050	2.798	2.300	1.874	1.213
+100 m (cm)		-5,0	0	-3,7	-12,8	-52,5
MRD +171m (cm)		-5,0	+4,0	+2,3	-4,8	-40,5

20 units per package (Art.-Nr. 091137)

.30-06  
12,0 g / 185 grs



Distance		0	100	150	200	300
Velocity (m/s)		835	755	717	679	609
Energy (J)		4.184	3.420	3.082	2.770	2.222
+100 m (cm)		-5,0	0	-3,7	-12,3	-45,8
MRD +172 m (cm)		-5,0	+4,0	+2,3	-4,3	-33,8

20 units per package (Art.-Nr. 080238)



















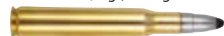

# Overview Rifle Ammunition



















All BRENNKE ammunition is also available for reloader.

Please, find an overview on page 58 and 59.

<p><b>.243 Win.</b></p> <ul style="list-style-type: none"> <li>TOG® 6,2 g / 96 grs</li> </ul> 	<p><b>6,5 x 55 SE   6,5 x 57   6,5 x 57 R</b></p> <ul style="list-style-type: none"> <li>TAG® 8,4 g / 130 grs <b>NEW!</b></li> </ul> 	<p><b>.270 Win.</b></p> <ul style="list-style-type: none"> <li>TAG® 8,4 g / 130 grs <b>NEW!</b></li> <li>TM 8,4 g / 130 grs <b>NEW!</b></li> </ul> 	<p><b>7x57</b></p> <ul style="list-style-type: none"> <li>TIG® 11,5 g / 177 grs</li> <li>TAG® 10,4 g / 160 grs <b>NEW!</b></li> </ul> 
<p><b>7x57 R</b></p> <ul style="list-style-type: none"> <li>TIG® 11,5 g / 177 grs</li> <li>TAG® 10,4 g / 160 grs <b>NEW!</b></li> <li>TOG® 9,7 g / 150 grs</li> </ul> 	<p><b>7x64</b></p> <ul style="list-style-type: none"> <li>TIG® 11,5 g / 177 grs</li> <li>TUG® nature+ 8,3 g / 128 grs</li> <li>TOG® 9,7 g / 150 grs</li> <li>TAG® 10,4 g / 160 grs <b>NEW!</b></li> <li>TM® 9,4 g / 145 grs <b>NEW!</b></li> </ul> 	<p><b>7x65 R</b></p> <ul style="list-style-type: none"> <li>TIG® 11,5 g / 177 grs</li> <li>TUG® nature+ 8,3 g / 128 grs</li> <li>TOG® 9,7 g / 150 grs</li> <li>TAG® 10,4 g / 160 grs <b>NEW!</b></li> <li>TM® 9,4 g / 145 grs <b>NEW!</b></li> </ul> 	<p><b>7mm Rem. Mag.</b></p> <ul style="list-style-type: none"> <li>TIG® 11,5 g / 177 grs</li> <li>TOG® 9,7 g / 150 grs <b>NEW!</b></li> <li>TM® 9,4 g / 145 grs <b>NEW!</b></li> </ul> 
<p><b>.308 Win.</b></p> <ul style="list-style-type: none"> <li>TIG® 9,7 g / 150 grs <b>NEW!</b></li> <li>TUG® 11,7 g / 181 grs</li> <li>TUG® nature+ 9,5 g / 147 grs</li> <li>TOG® 10,7 g / 165 grs</li> <li>TAG® 10,0 g / 155 grs</li> <li>BASIC 12,0 g / 185 grs</li> </ul> 	<p><b>.30-06</b></p> <ul style="list-style-type: none"> <li>TIG® 9,7 g / 150 grs <b>NEW!</b></li> <li>TUG® 11,7 g / 181 grs</li> <li>TUG® nature+ 9,5 g / 147 grs</li> <li>TOG® 10,7 g / 165 grs</li> <li>TAG® 10,0 g / 155 grs</li> <li>BASIC 12,0 g / 185 grs</li> </ul> 	<p><b>.30 R Blaser</b></p> <ul style="list-style-type: none"> <li>TUG® 11,7 g / 181 grs</li> <li>TUG® nature+ 9,5 g / 147 grs</li> </ul> 	<p><b>.300 Win. Mag.</b></p> <ul style="list-style-type: none"> <li>TUG® 11,7 g / 181 grs</li> <li>TUG® nature+ 9,5 g / 147 grs</li> <li>TOG® 10,7 g / 165 grs</li> <li>TAG® 10,0 g / 155 grs</li> <li>BASIC 12,0 g / 185 grs</li> </ul> 
<p><b>8x57 JS</b></p> <ul style="list-style-type: none"> <li>TIG® 12,8 g / 198 grs</li> <li>TUG® nature+ 9,7 g / 150 grs</li> <li>TOG® 11,7 g / 181 grs</li> <li>TAG® 11,3 g / 175 grs</li> <li>BASIC 13,0 g / 200 grs</li> </ul> 	<p><b>8x57 JRS</b></p> <ul style="list-style-type: none"> <li>TIG® 12,8 g / 198 grs</li> <li>TUG® nature+ 9,7 g / 150 grs</li> <li>TOG® 14,2 g / 220 grs</li> <li>TAG® 11,3 g / 175 grs</li> <li>BASIC 13,0 g / 200 grs</li> </ul> 	<p><b>8x64 S</b></p> <ul style="list-style-type: none"> <li>TIG® 12,8 g / 198 grs</li> <li>TOG® 14,2 g / 220 grs</li> </ul> 	<p><b>8x68 S</b></p> <ul style="list-style-type: none"> <li>TIG® 12,8 g / 198 grs</li> <li>TUG® nature+ 9,7 g / 150 grs</li> <li>TOG® 14,2 g / 220 grs</li> </ul> 
<p><b>9,3x62</b></p> <ul style="list-style-type: none"> <li>TUG® 19,0 g / 293 grs</li> <li>TUG® nature+ 14,2 g / 220 grs</li> <li>TOG® 16,0 g / 247 grs</li> <li>TAG® 14,6 g / 225 grs</li> </ul> 	<p><b>9,3x64</b></p> <ul style="list-style-type: none"> <li>TUG® 19,0 g / 293 grs</li> <li>TOG® 16,0 g / 247 grs</li> </ul> 	<p><b>9,3x74 R</b></p> <ul style="list-style-type: none"> <li>TUG® 19,0 g / 293 grs</li> <li>TUG® nature+ 14,2 g / 220 grs</li> <li>TOG® 16,0 g / 247 grs</li> <li>TAG® 14,6 g / 225 grs</li> </ul> 	<p><b>.375 H&amp;H Mag.</b></p> <ul style="list-style-type: none"> <li>TOG® 17,5 g / 270 grs</li> </ul> 

# Overview Slug Ammunition



   	<p><b>12/76</b></p> <ul style="list-style-type: none"> <li>SuperMagnum 39,0 g / 600 grs</li> <li>RubinSabot 28,0 g / 432 grs</li> <li>SuperSabot 31,8 g / 490 grs*</li> <li>Opal Magnum 43,0 g / 666 grs*</li> </ul>	     	<p><b>12/70</b></p> <ul style="list-style-type: none"> <li>Classic 31,5 g / 490 grs</li> <li>Classic Magnum 31,5 g / 490 grs <b>NEW!</b></li> <li>Camou 28,4 g / 440 grs</li> <li>RubinSabot 28,0 g / 432 grs</li> <li>RubinSabot nature 19,0 g / 293 grs</li> <li>SuperSabot 31,8 g / 490 grs*</li> <li>ATS 27,5 g / 424 grs</li> </ul>		
	<p><b>12/67,5</b></p> <ul style="list-style-type: none"> <li>K.O. CleanSpeed Plus 28,4 g / 440 grs</li> </ul> <p>Slugs for target shooting disciplines, not suitable for hunting.</p>		<p><b>12/60</b></p> <ul style="list-style-type: none"> <li>K.O. CleanSpeed Short 28,4 g / 440 grs</li> </ul>	 	<p><b>16/70</b></p> <ul style="list-style-type: none"> <li>Classic 27,0 g / 415 grs</li> <li>Camou 23,0 g / 355 grs</li> </ul>
	<p><b>20/76</b></p> <ul style="list-style-type: none"> <li>SuperMagnum 28,4 g / 440 grs</li> </ul>		<p><b>20/70</b></p> <ul style="list-style-type: none"> <li>Classic 24,0 g / 370 grs</li> </ul>		<p><b>28/70</b></p> <ul style="list-style-type: none"> <li>Camou 18,3 g / 282 grs</li> </ul>

\*Must not be used in choke barrels.



# .30 R Blaser



.30 R Blaser  
11,7 g / 181 grs



Distance		0	100	150	200	300
Velocity	(m/s)	860	774	733	693	617
Energy	(J)	4.327	3.505	3.143	2.809	2.227
±100m	(cm)	-5,0	0	-3,4	-11,5	-43,5
MRD ±176m	(cm)	-5,0	+4,0	+2,6	-3,4	-31,4

20 units per package (Art.-Nr. 070635)

.30 R Blaser  
9,5 g / 147 grs



Distance		0	100	150	200	300
Velocity	(m/s)	970	834	771	711	598
Energy	(J)	4.469	3.304	2.823	2.399	1.700
±100m	(cm)	-5,0	0,0	-2,5	-9,1	-37,7
MRD ±187m	(cm)	-5,0	+3,8	+3,1	-1,6	-26,7

20 units per package (Art.-Nr. 061533)



# Hightech Ammunition Development



News from  
the BRENNKE  
research lab

*Hunting ammunition is considered one of the most sophisticated types of ammunition on the market. A cutting-edge bullet construction lays the foundation for the most crucial success factors:*

- reliable knock-down power according to best hunting practice
- unmistakable stalking signs such as a sharp cutting edge
- best possible game preservation
- optimal penetration for best ballistics

*Design, material and loading form the cornerstones for innovation development. Becoming increasingly important is the „lead-free“ topic. Many products in the market cannot compete with the impact of ammunition that contains lead. In our BRENNKE laboratory we thrive to continuously optimize renown quality. Following our tradition, we are still promoting pioneering work for successful expert hunting.*

# .300 Win. Mag.



.300 Win. Mag.  
11,7 g / 181 grs



Distance	0	100	150	200	300
Velocity (m/s)	940	849	805	763	683
Energy (J)	5.169	4.217	3.791	3.406	2.729
±100m (cm)	-5,0	0	-2,4	-8,7	-34,3
MRD ±192m (cm)	-5,0	+3,9	+3,4	-0,9	-22,6

20 units per package (Art.-Nr. 070335)

.300 Win. Mag.  
9,5 g / 147 grs

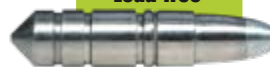

Lead-free

Distance	0	100	150	200	300
Velocity (m/s)	990	852	788	727	613
Energy (J)	4.655	3.448	2.950	2.511	1.786
±100m (cm)	-5,0	0,0	-2,3	-8,6	-36,0
MRD ±191m (cm)	-5,0	+3,7	+3,3	-1,1	-24,8

20 units per package (Art.-Nr. 060533)



# .300 Win. Mag.



.300 Win. Mag.  
10,7 g / 165 grs



Distance	0	100	150	200	300
Velocity (m/s)	970	892	854	818	748
Energy (J)	5.030	4.252	3.902	3.580	2.991
±100m (cm)	-5,0	0	-2,0	-7,4	-29,3
MRD ±200m (cm)	-5,0	+3,7	+3,5	0	-18,2

20 units per package (Art.-Nr. 031636)

.300 Win. Mag.  
10,0 g / 155 grs



Lead-free

Distance	0	100	150	200	300
Velocity (m/s)	990	829	755	685	556
Energy (J)	4.920	3.447	2.859	2.354	1.553
±100 m (cm)	-5,0	0,0	-2,6	-9,5	-40,2
MRD ±186m (cm)	-5,0	+3,8	+3,1	-1,9	-28,8

20 units per package (Art.-Nr. 091537)

.300 Win. Mag.  
12,0 g / 185 grs



Distance	0	100	150	200	300
Velocity (m/s)	930	844	803	764	688
Energy (J)	5.190	4.277	3.873	3.500	2.838
±100m (cm)	-5,0	0	-2,5	-8,8	-34,5
MRD ±190m (cm)	-5,0	+3,8	+3,2	-1,2	-23,0

20 units per package (Art.-Nr. 080338)



# 8x57 JS



8 x 57 JS  
12,8 g / 198 grs



Distance		0	100	150	200	300
Velocity	(m/s)	800	720	681	644	573
Energy	(J)	4.096	3.318	2.968	2.654	2.101
⊕100m	(cm)	-5,0	0	-4,4	-14,0	-51,9
MRD ⊕164m	(cm)	-5,0	+4,0	+1,6	-6,0	-39,8

20 units per package (Art.-Nr. 050435)

8 x 57 JS  
9,7 g / 150 grs



Distance		0	100	150	200	300
Velocity	(m/s)	880	751	691	633	527
Energy	(J)	3.756	2.735	2.314	1.946	1.349
⊕100m	(cm)	-5,0	0,0	-3,7	-12,6	-49,9
MRD ⊕173m	(cm)	-5,0	+4,1	+2,5	-4,4	-37,6

20 units per package (Art.-Nr. 075137)

# 8x57 JS



8 x 57 JS  
11,7 g / 181 grs



Distance		0	100	150	200	300
Velocity	(m/s)	810	709	661	616	530
Energy	(J)	3.848	2.949	2.566	2.223	1.647
⊕100m	(cm)	-5,0	0,0	-4,5	-14,6	-55,4
MRD ⊕163m	(cm)	-5,0	+4,0	+1,5	-6,6	-43,4

20 units per package (Art.-Nr. 032536)

8 x 57 JS  
11,3 g / 175 grs

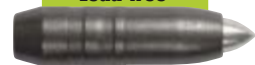

Distance		0	100	150	200	300
Velocity	(m/s)	844	685	612	544	426
Energy	(J)	4.025	2.649	2.116	1.672	1.027
⊕100m	(cm)	-5,0	0	-4,9	-16,0	-66,8
MRD ⊕160m	(cm)	-5,0	+4,1	+1,2	-8,1	-54,6

20 units per package (Art.-Nr. 091237)

8 x 57 JS  
13,0 g / 200 grs



Distance		0	100	150	200	300
Velocity	(m/s)	795	713	674	636	563
Energy	(J)	4.108	3.304	2.953	2.629	2.060
⊕100m	(cm)	-5,0	0	-4,6	-14,5	-53,0
MRD ⊕162m	(cm)	-5,0	+4,0	+1,4	-6,6	-41,1

20 units per package (Art.-Nr. 080438)



# 8x57 JRS



8 x 57 JRS  
12,8 g / 198 grs



Distance		0	100	150	200	300
Velocity (m/s)		750	673	636	600	532
Energy (J)		3.600	2.899	2.589	2.304	1.811
+100m (cm)		-5,0	0	-5,4	-16,8	-61,0
MRD +155m (cm)		-5,0	+4,0	+0,7	-8,7	-49,0

20 units per package (Art.-Nr. 050535)

8 x 57 JRS  
9,7 g / 150 grs



Distance		0	100	150	200	300
Velocity (m/s)		830	705	647	592	491
Energy (J)		3.341	2.414	2.032	1.700	1.170
+100m (cm)		-5,0	0,0	-4,5	-14,9	-58,2
MRD +164m (cm)		-5,0	+4,2	+1,8	-6,5	-45,6

20 units per package (Art.-Nr. 075136)

# 8x57 JRS



8 x 57 JRS  
14,2 g / 220 grs



Distance		0	100	150	200	300
Velocity (m/s)		700	634	603	573	515
Energy (J)		3.494	2.870	2.593	2.338	1.891
+100m (cm)		-5,0	0,0	-6,4	-19,4	-68,9
MRD +146m (cm)		-5,0	+3,9	-0,5	-11,7	-57,3

20 units per package (Art.-Nr. 031736)

8 x 57 JRS  
11,3g / 175 grs

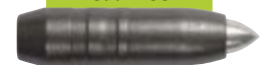

Distance		0	100	150	200	300
Velocity (m/s)		800	646	576	511	401
Energy (J)		3.616	2.358	1.872	1.476	910
+100m (cm)		-5,0	0	-5,6	-19,1	-76,7
MRD +153m (cm)		-5,0	+4,0	+0,4	-11,0	-64,6

20 units per package (Art.-Nr. 091337)

8 x 57 JRS  
13,0 g / 200 grs



Distance		0	100	150	200	300
Velocity (m/s)		740	661	624	587	519
Energy (J)		3.559	2.840	2.531	2.240	1.751
+100m (cm)		-5,0	0	-5,6	-17,3	-63,8
MRD +167m (cm)		-5,0	+4,0	+0,4	-9,3	-51,8

20 units per package (Art.-Nr. 080538)





# 8x64 S BRENNEKE

# 8x68 S



8 x 64 S  
12,8 g / 198 grs



Distance	0	100	150	200	300
Velocity (m/s)	848	762	722	682	607
Energy (J)	4.600	3.720	3.333	2.979	2.358
+100m (cm)	-5,0	0	-3,5	-11,8	-44,7
MRD +174m (cm)	-5,0	+4,0	+2,4	-3,9	-32,9

20 units per package (Art.-Nr. 050635)

8 x 68 S  
12,8 g / 198 grs



Distance	0	100	150	200	300
Velocity (m/s)	900	813	771	731	654
Energy (J)	5.184	4.228	3.807	3.419	2.737
+100m (cm)	-5,0	0	-2,9	-9,8	-38,2
MRD +185m (cm)	-5,0	+3,9	3,0	-1,9	-26,5

20 units per package (Art.-Nr. 050735)

8 x 64 S  
14,2 g / 220 grs



Distance	0	100	150	200	300
Velocity (m/s)	780	710	677	644	582
Energy (J)	4.320	3.582	3.253	2.947	2.402
+100m (cm)	-5,0	0	-4,6	-14,6	-52,3
MRD +162m (cm)	-5,0	+4,0	+1,4	-6,6	-40,2

20 units per package (Art.-Nr. 032636)

8 x 68 S  
9,7 g / 150 grs

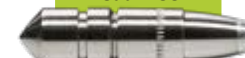

Distance	0	100	150	200	300
Velocity (m/s)	1010	868	803	740	624
Energy (J)	4.947	3.656	3.125	2.657	1.886
+100m (cm)	-5,0	0,0	-2,2	-8,1	-34,3
MRD +197m (cm)	-5,0	+3,9	+3,7	-0,3	-22,7

20 units per package (Art.-Nr. 075138)

8 x 68 S  
14,2 g / 220 grs



Distance	0	100	150	200	300
Velocity (m/s)	840	767	732	698	633
Energy (J)	5.031	4.197	3.824	3.476	2855
+100m (cm)	-5,0	0,0	-3,6	-11,7	-43,6
MRD +174m (cm)	-5,0	+4,0	+2,4	-3,8	-31,7



20 units per package (Art.-Nr. 032736)



# 9,3 x 62





**9,3 x 62**  
19,0 g / 293 grs

Distance	0	100	150	200	300
Velocity (m/s)	740	680	651	623	569
Energy (J)	5.202	4.393	4.026	3.687	3.076
+100m (cm)	-5,0	0	-5,2	-16,3	-57,9
MRD +156m (cm)	-5,0	+4,0	+0,8	-8,2	-45,8

20 units per package (Art.-Nr. 070435)

**9,3 x 62**  
14,2 g / 220 grs

**Lead-free**



Distance	0	100	150	200	300
Velocity (m/s)	825	723	674	628	541
Energy (J)	4.853	3.725	3.244	2.812	2.087
+100m (cm)	-5,0	0,0	-4,2	-13,8	-52,4
MRD +165m (cm)	-5,0	+4,0	+1,7	-5,9	-40,9

20 units per package (Art.-Nr. 060933)

# 9,3 x 62





**9,3 x 62**  
16,0 g / 247 grs

Distance	0	100	150	200	300
Velocity (m/s)	810	740	707	674	612
Energy (J)	5.249	4.380	3.999	3.634	2.996
+100m (cm)	-5,0	0	-4,0	-12,9	-47,4
MRD +169m (cm)	-5,0	+4,0	+2,0	-4,9	-35,4

20 units per package (Art.-Nr. 031836)

**9,3 x 62**  
14,6 g / 225 grs

**Lead-free**

Distance	0	100	150	200	300
Velocity (m/s)	820	668	598	533	421
Energy (J)	4.908	3.257	2.615	2.077	1.293
+100m (cm)	-5,0	0	-5,2	-17,3	-70,2
MRD +156m (cm)	-5,0	+4,0	+0,8	-9,4	-58,2

20 units per package (Art.-Nr. 091437)



# 9,3 x 74 R



9,3 x 74 R  
19,0 g / 293 grs

Distance	0	100	150	200	300
Velocity (m/s)	695	637	610	582	531
Energy (J)	4.589	3.855	3.535	3.218	2.679
+100m (cm)	-5,0	0	-6,3	-19,2	-67,5
MRD +148m (cm)	-5,0	+4,0	-0,3	-11,2	-55,5

20 units per package (Art.-Nr. 070535)

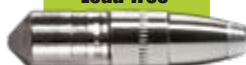

Lead-free

9,3 x 74 R  
14,2 g / 220 grs

Distance	0	100	150	200	300
Velocity (m/s)	780	681	634	590	506
Energy (J)	4.338	3.307	2.869	2.478	1.827
+100m (cm)	-5,0	0,0	-5,1	-16,3	-61,1
MRD +161m (cm)	-5,0	+4,0	+0,9	-8,3	-49,1

20 units per package (Art.-Nr. 061033)

# 9,3 x 74 R



9,3 x 74 R  
16,0 g / 247 grs

Distance	0	100	150	200	300
Velocity (m/s)	750	683	651	620	561
Energy (J)	4.500	3.732	3.390	3.075	2.518
+100m (cm)	-5,0	0	-5,2	-16,0	-57,1
MRD +157m (cm)	-5,0	+4,0	+0,9	-7,9	-45,0

20 units per package (Art.-Nr. 032836)

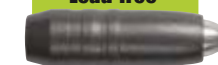

Lead-free

9,3 x 74 R  
14,6 g / 225 grs

Distance	0	100	150	200	300
Velocity (m/s)	780	632	564	502	397
Energy (J)	4.435	2.911	2.321	1.840	1.150
+100m (cm)	-5,0	0	-6,1	-20,1	-80,2
MRD +150m (cm)	-5,0	+4,0	0	-12,1	-68,1

20 units per package (Art.-Nr. 091637)



# 9,3 x 64 BRENNEKE



9,3 x 64  
19,0 g / 293 grs



Distance	0	100	150	200	300
Velocity (m/s)	785	723	693	664	608
Energy (J)	5.854	4.966	4.562	4.189	3.512
+100m (cm)	-5,0	0	-4,4	-13,8	-50,0
MRD +165m (cm)	-5,0	+4,0	+1,7	-5,8	-37,9

20 units per package (Art.-Nr. 070735)

# .375 H&H Mag.



.375 H&H Mag.  
17,5 g / 270 grs



Distance	0	100	150	200	300
Velocity (m/s)	835	764	730	697	633
Energy (J)	6.104	5.113	4.668	4.253	3.511
+100m (cm)	-5,0	0	-3,5	-11,7	-43,9
MRD +175m (cm)	-5,0	+4,0	+2,5	-3,7	-31,9

20 units per package (Art.-Nr. 032236)

9,3 x 64  
16,0 g / 247 grs



Distance	0	100	150	200	300
Velocity (m/s)	862	789	754	720	655
Energy (J)	5.954	4.985	4.554	4.152	3.433
+100m (cm)	-5,0	0	-3,2	-10,6	-40,5
MRD +180m (cm)	-5,0	+3,9	+2,7	-2,8	-28,7

20 units per package (Art.-Nr. 031336)





# Bullets for Reloaders

## 6 mm / .243 Diam.

TOG®	6,2 g/96 grs	(Art.-Nr. 530836)
------	--------------	-------------------

## 6,5 mm / .264 Diam.

TAG® <b>NEW!</b>	8,4 g/130 grs	(Art.-Nr. 590336)
------------------	---------------	-------------------

## .270 / .277 Diam.

TAG® <b>NEW!</b>	8,4 g/130 grs	(Art.-Nr. 590736)
------------------	---------------	-------------------

## 7 mm / .284 Diam.

TIG®	11,5 g/177 grs	(Art.-Nr. 550235)
TUG® nature+	8,3 g/128 grs	(Art.-Nr. 560334)
TOG®	9,7 g/150 grs	(Art.-Nr. 530436)
TAG® <b>NEW!</b>	10,4 g/160 grs	(Art.-Nr. 590236)
TM <b>NEW!</b>	9,4 g/145 grs	(Art.-Nr. 520137)

## .308 Diam.

TIG® <b>NEW!</b>	9,7 g/150 grs	(Art.-Nr. 550335)
TUG®	11,7 g/181 grs	(Art.-Nr. 570135)
TUG® nature+	9,5 g/147 grs	(Art.-Nr. 560233)
TOG®	10,7 g/165 grs	(Art.-Nr. 530136)
TAG®	10,0 g/155 grs	(Art.-Nr. 590136)
Basic <b>NEW!</b>	12,0 g/185 grs	(Art.-Nr. 520237)

## 8 mm S / .323 Diam.

TIG®	12,8 g/198 grs	(Art.-Nr. 550435)
TUG® nature+	9,7 g/150 grs	(Art.-Nr. 560434)
TOG®	11,7 g/181 grs	(Art.-Nr. 530636)
TOG®	14,2 g/220 grs	(Art.-Nr. 530236)
TAG®	11,3 g/175 grs	(Art.-Nr. 590436)
Basic <b>NEW!</b>	13,0 g/200 grs	(Art.-Nr. 520337)

25 units per package

## 9,3 mm / .366 Diam.

TUG®	19,0 g/293 grs	(Art.-Nr. 570335)
TUG® nature+	14,2 g/220 grs	(Art.-Nr. 560433)
TOG®	16,0 g/247 grs	(Art.-Nr. 530336)
TAG®	14,6 g/225 grs	(Art.-Nr. 590636)

## .375 Diam.

TOG®	17,5 g/270 grs	(Art.-Nr. 530536)
------	----------------	-------------------

## 10,3 mm / .413 Diam.

TOG®	15,2 g/235 grs	(Art.-Nr. 530736)
------	----------------	-------------------

All BRENNEKE bullets are also available for reloaders. We are happy to give you expert advice choosing the right loads!

Please, feel free to ask for any advice on ballistics or the right use of BRENNEKE bullets.

Download tested reloader data for free at [www.brenneke.com](http://www.brenneke.com) or call us at +49 511 972 62 0.



# Mass Matters

Stay on the safe side.  
In every situation.



*No kidding: If you take the "big pill", you want big impact – with as little risks and side effects as possible. The BRENNKE slug is designed for huge mass stopping power that excels the impact of any bullet – on drive hunts as well as on African big game. And it comes with an important safety factor for hunters: since it flies at a relatively slow speed a diverted slug can be heard easily.*

ORIGINAL  
**BRENNEKE**<sup>®</sup>

# Game Over

Best ballistic data.  
Proven a million times.



*Shuttlecock and slug ammunition, is it absurd to compare the two? As a matter of fact, their ballistic principle is very similar: the centre of gravity lies at the front. As part of the typical BRENNEKE design the trajectory is stabilized by a plug. It also shows angular ribs to avoid a spin and ensure a smooth choke passage. The result: even heavy game will be stopped reliably on a shooting distance of 50 meters.*



# Classic



Legendary stopping power drives hunting success

The production of the classic BRENNEKE with felt rear has started in 1898. In 2005, we started using an optimized version. Original BRENNEKE rounds contain loads that are perfectly tuned for the various ammunitions. The CLASSIC slug offers highest accuracy and striking energy. This applies equally



to driven hunts, deer-stalking and tracking within a distance of 50 meters. The CLASSIC comes in a handy container with 5 slugs.

# Classic Magnum



The Classic with extra energy

- high accuracy: 5 cm with 5 shots at 50 m
- extraordinary stopping power
- deep penetration and exit wound
- for almost all kind of hunts
- universal use in all firearms, with and without choke up to 50 m



12/70  
31,5 g / 490 grs

12/70  
31,5 g / 490 grs

Distance	0	25	50	75	100
Velocity (m/s)	430	370	330	300	275
Energy (J)	2.912	2.156	1.715	1.418	1.191
Trajectory (cm)	-2,0	+3,1	+3,6	-1,7	-13,8

Distance	0	25	50	75	100
Velocity (m/s)	460	400	352	319	297
Energy (J)	3.335	2.520	1.951	1.604	1.389
Trajectory (cm)	-2,0	+0,3	+1,3	+0,7	-1,9

5 units per package (Art.-Nr. 1201620)

5 units per package (Art.-Nr. 1201720)

For use in all shotguns – with or without choke

16/70  
27,0 g / 415 grs

Distance	0	25	50	75	100
Velocity (m/s)	415	360	322	296	277
Energy (J)	2.325	1.746	1.397	1.185	1.037
Trajectory (cm)	-2,0	+3,1	+3,5	-1,9	-14,2

5 units per package (Art.-Nr. 1601620)

20/70  
24,0 g / 370 grs

Distance	0	25	50	75	100
Velocity (m/s)	430	371	329	302	281
Energy (J)	2.219	1.653	1.301	1.092	951
Trajectory (cm)	-2,0	+3,1	+3,7	-1,2	-12,8

5 units per package (Art.-Nr. 2001620)

For use in all shotguns – with or without choke



# Rubin Sabot

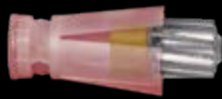

# Rubin Sabot

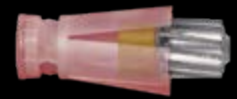

## Valuable impact for combination guns

Ultimate in muzzle velocity, energy, reach and precision?  
BRENNEKE has got a name for it: RubinSabot.

RubinSabot is your choice whenever you need reliable shotgun ammunition, may it be for a drive hunt, for stalking or raised stand. It is ideal for one barrel shotguns as well as combination guns.

### Ingenious Functionality

Specially tailored to the needs of European hunters, it combines the advantages of a classic slug in 20 ga with the benefits of a sabot.

Leaving a smooth bore, the aerodynamic drag opens the RubinSabot's carcass; it drops after approx. 15 meters. The slug, however, continues to fly straight to the target.

Persistent Performance Optimization.  
2001: First RubinSabot

Sabot constructions imply that the diameter of the slug is smaller than the muzzle. A 28,4 gram projectile has a 16 millimeter diameter corresponding to a calibre 20. Thus, the bullet should be called a 12/20/70. Only when jacketing it with a synthetic carcass the actual diameter in calibre 12 (18,5 mm) is reached.

2012: Better Loads

The high velocity (+13 % at 50 m in comparison to CAMOU) and very high energy (+25 % at 50m in comparison to CAMOU) deliver excellent precision results of 4 cm group with 5 shots at 50 m.



Calibres 12/70 and 12/76 are suitable for all types of hunting up to 80 m – provided shooting shotgun or combination gun with a rifle scope.

Due to the golden coloured rear and the reddish carcass, our new BRENNEKE models with optimized load can be identified at first sight.

All BRENNEKE sabots come with 12 characteristic angular ribs to ensure any choke passage.

12/70  
28,0 g /432 grs



Distance		0	25	50	75	100
Velocity	(m/s)	468	417	374	340	316
Energy	(J)	3.067	2.432	1.954	1.620	1.397
Trajectory	(cm)	-5,0	+1,3	+4,0	+2,3	-4,6

5 units per package (Art.-Nr. 1212622)

For use in all shotguns – with or without choke

12/76  
28,0 g /432 grs



Distance		0	25	50	75	100
Velocity	(m/s)	519	462	412	369	337
Energy	(J)	3.771	2.986	2.371	1.910	1.591
Trajectory	(cm)	-5,0	+0,9	+3,8	+3,2	-1,9

5 units per package (Art.-Nr. 1212522)

For use in all shotguns – with or without choke

## Slug Ammunition

# RubinSabot nature

## Lead-free in every territory

Adding value to your hunt:  
RubinSabot nature

The 19 g slug has a velocity of 610 m/s at the muzzle and can be used just like a lead slug. The energy at 50 m is still at 1.888 J which is 10% more than the regular 12/70 Classic offers.

Tin was chosen for the material because it is foodsafe and reacts in a way similar to lead. The universally applicable RubinSabot nature is a perfect pick for hunting in territories that are "lead-free".



# RubinSabot nature



More advantages:

- suitable for all types of hunting up to 80 m
- for use in all shotguns – with or without choke
- ideal stabilisation due to front center of gravity
- quick, safe and reliable target impact

**Lead-free**



12/70

19,0 g / 293 grs

Distance		0	25	50	75	100
Velocity	(m/s)	610	523	446	382	336
Energy	(J)	3.535	2.598	1.888	1.389	1.074
Trajectory	(cm)	-5,0	+0,4	+3,6	+3,7	-0,5

5 units per package (Art.-Nr. 1212722)

For use in all shotguns – with or without choke

ORIGINAL  
**BRENNEKE**

# Camou®



# SuperMagnum



Accuracy for shooting training and hunting practice

Very reasonably priced for use in shooting cinema and hunting.

Ideal for drive hunts or stalking with perfect impact up to 40 meters.



Special coating for minimal leading of the barrel.



A power package that masters every challenge

Both SuperMagnum cartridges are suitable for all types of hunting up to approximately 100 meters.

Are you looking for outstanding knock-down power with utmost accuracy? Then, the SuperMagnum is the choice for you. Its specially alloyed, extra hard lead head results in maximum penetrating power. Its rear portion guarantees optimal gas pressure distribution and perfect external ballistics.

Original BRENNEKE slugs perfectly complement your rifle bullet assortment for universal use.

12/70  
28,4 g / 440 grs



Distance	0	25	50	75	100
Velocity (m/s)	460	384	331	299	276
Energy (J)	3.000	2.092	1.557	1.267	1.080
Trajectory (cm)	-2,0	+3,0	+3,8	-0,9	-12,2

5 units per package (Art.-Nr. 127024)

16/70  
23 g / 355 grs



Distance	0	25	50	75	100
Velocity (m/s)	480	420	371	334	308
Energy (J)	2.650	2.032	1.582	1.281	1.090
Trajectory (cm)	-5,0	-0,8	+0,0	-3,7	-12,9

5 units per package (Art.-Nr. 167024)

28/70  
18,3 g / 282 grs



Distance	0	25	50	75	100
Velocity (m/s)	412	350	311	285	266
Energy (J)	1.549	1.120	885	745	646
Trajectory (cm)	-1,0	+2,0	0	-8,2	-23,7

5 units per package (Art.-Nr. 287024)

For use in all shotguns – with or without choke

12/76  
39,0 g / 600 grs



Distance	0	25	50	75	100
Velocity (m/s)	450	383	335	304	282
Energy (J)	3.947	2.862	2.188	1.803	1.552
Trajectory (cm)	-5,0	+2,2	+5,1	+2,7	-6,2

5 units per package (Art.-Nr. 1202525)

20/76  
28,4 g / 440 grs



Distance	0	25	50	75	100
Velocity (m/s)	450	399	357	326	304
Energy (J)	2.874	2.261	1.810	1.509	1.312
Trajectory (cm)	-2,0	+3,6	+5,3	-2,2	-6,7

5 units per package (Art.-Nr. 2002525)

For use in all shotguns – with or without choke

## Slug Ammunition

70 Sale of ammunition to holders of appropriate permits and authorizations only.



71

# SuperSabot



## Wit versus resistance

The SuperSabot's controlled mushrooming is dependent on its target resistance.

It is ideal for use with rifled barrels. However, if you prefer a smooth barrel, chokes must be omitted.

Sabot technology guarantees utmost accuracy up to 100 meters.



12/76  
31,8 g /490 grs

Distance		0	25	50	75	100
Velocity (m/s)		465	416	374	341	317
Energy (J)		3.438	2.746	2.220	1.849	1.598
Trajectory (cm)		-5,0	+1,4	+4,2	+2,6	-4,3

5 units per package (Art.-Nr. 1210522)

12/70  
31,8 g /490 grs



Distance		0	25	50	75	100
Velocity (m/s)		429	385	350	323	304
Energy (J)		2.926	2.356	1.942	1.661	1.467
Trajectory (cm)		-5,0	+2,0	+4,9	+2,7	-5,2

5 units per package (Art.-Nr. 1210622)

Only for use in rifled or smooth barrels without choke!

# OpalMagnum



## Bundles of energy

There is probably nothing more impressive than the 12/76 OpalMagnum. Equipped with a 43,0 g / 666 grs slug, it proves extremely powerful with 2.173 Joule of energy at 100 m.

This means that OpalMagnum is the perfect choice for hunting heavy and dangerous game. Also, precision is extraordinary due to the broad ribs reinforcing the angular momentum. 5 shots are placed within 10 cm groups at 100 m. As an additional advantage lead abrasion in the barrel is reduced by a special coating of the point.

## Special unit in action

We recommend this speciality slug for shotguns with cylindric barrels. It can be used with smooth and rifled barrels, however not with a choke.

When hunting heavy and dangerous game such as buffalo or lion the OpalMagnum is your most indispensable partner.



12/76  
43,0 g /666 grs

Distance		0	25	50	75	100
Velocity (m/s)		491	433	384	345	318
Energy (J)		5.184	4.026	3.166	2.564	2.173
Trajectory (cm)		-5,0	+1,1	+4,0	+2,7	-3,8

5 units per package (Art.-Nr. 120416)

Only for use in rifled or smooth barrels without choke!





**We are the Champions:  
K.O. CleanSpeed Short & K.O. CleanSpeed Plus**

Get off to a flying start with BRENNEKE K.O. CleanSpeed, the most successful cartridge in dynamic shotgun shooting. Both versions, the K.O. CleanSpeed Short 12/60 (for K.O. Cleanspeed pump action shotguns) and the K.O. CleanSpeed Plus 12/67 (for semi-automatic shotguns) are perfectly tuned for shotgun actions (semi-automatic or pump).

Winning qualities such as outstanding accuracy with reduced recoil and maximum magazine capacity will take you to the lead. In addition, CleanSpeed coating reduces lead fouling in the barrel by 99.83 % (according to TÜV expert reports). This improves the accuracy of the weapon and greatly reduces cleaning time as well as health risks caused by lead.

Both loads contain the well-proven 28,4 g / 440 grs slug and will be available in a new handy box of 100 pcs.



## Short 12/60

- Perfect for pump actions
- Reduced length of the cartridges for maximum magazine capacity (+1)
- cal. 12/60 for 60, 65, 70 and 76

12/60  
28,4 g / 440 grs



Distance		0	25	50	75	100
Velocity	(m/s)	380	334	303	282	265
Trajectory	(cm)	-5,0	+0,2	0	-6,8	-21,2

100 units per package (Art.-Nr. 1203211)

Not suitable for hunting!

## Plus 12/67

- Especially balanced for perfect function in semi automatic shotguns
- Reduced length of the cartridge for maximum magazine capacity
- cal. 12/67 für 65, 70 und 76er

12/67,5  
28,4 g / 440 grs



Distance		0	25	50	75	100
Velocity	(m/s)	425	365	324	297	277
Trajectory	(cm)	-5,0	-0,2	0	-5,6	-17,9

100 units per package (Art.-Nr. 1212211)

Not suitable for hunting!

# BRENNEKE ATS®



# BRENNEKE ATS®



## The Anti-Terror-Slug by BRENNEKE

The need for security in Europe is increasing significantly, due to the current threat of terrorist attacks. Unfortunately, the equipment of regular police forces is insufficient to respond to potential attacks. Ammunition that is capable of stopping violence immediately and effectively should be available in every police car or emergency vehicle, together with the appropriate gun.

One thing is evident: the cartridges in calibre 9 mm Para or Luger, which have been used by most European police forces so far, are hardly suitable for fighting terrorism. For ballistic reasons, they lack the power that is needed for an effective operation. This is also true if the cartridges are fired from a submachine gun.



This is where the new ATS® by BRENNEKE comes into play. The cartridge in calibre 12/70 has an extremely hard slug weighing 27.5 g (424 gr.). Within usual shooting distances of up to approx. 50 meters, it shows an outstanding stopping power and can be used with any type of shotgun barrel.

### Energy with supreme stopping power

The Original BRENNEKE Anti-Terror-Slug has a release of energy that is 5.7 times higher on 25 meters than a 9 mm Luger, and 4.5 times higher than a pistol cartridge on 50 meters.



Even in comparison with the 7.62x39 Kalashnikov rifle cartridge, it achieves 36% more energy on 25 meters and 3,5% more on 50 meters. Moreover, the energy is released considerably faster than with a pistol or rifle bullet.

By firing at appropriate materials (soap, steel register plates etc.), the indicated penetration performance was confirmed.

The investments required to use the BRENNEKE ATS® are relatively low. A robust, universally applicable shotgun (e.g. pump action weapon) with appropriate sights can be acquired for a few hundred dollars. With the Anti-Terror-Slug police and security forces – as well as other authorized persons – are provided with a highly effective instrument for the prevention and control of terrorist and other criminal activities.

12/70  
27,5 g / 424 grs



Distance	0	25	50	75	100
Velocity (m/s)	512	436	367	313	275
Energy (J)	3.578	2.594	1.843	1.338	1.032
Trajectory (cm)	-2,0	+2,2	+3,1	-0,5	-10,4

5 units per package (Art.-Nr. 12 38 40)

For use in all shotguns – with or without choke





# Weapon Care

## Give your gun a good treat!

*Only in rare cases, ammunition is the cause for faulty shooting precision. Mostly, it is due to poor maintenance. As a matter of fact, slugs and bullets cannot pass through the barrel properly if riflings and lands are congested with traces of powder or residues from burnt propelling charges.*

*Clean your hunting rifle or shotgun after every use. The German test and research institute for hunting and sports firearms DEVA explicitly recommends a combination of mechanical and chemical barrel cleaning, because lands are more likely to be congested by metal residues and traces of powder. In addition, humidity imposes the risk of barrel corrosion. Not only might this affect the point of impact it can also lead to increased gas pressure, which has to be avoided by all means!*

## Barrel wear and tear due to Carbon Steel Ammunition?

Background: Due to the raw material shortages towards the end of World War II, German bullet jackets were made from plain, rough Carbon steel. Those bullets did in fact grind the barrel and ruin precision.

Today: BRENNEKE employs high quality, fine-pored Carbon steel with a plated coating for the production of TIG® and TUG®. The outside of the bullet is thinly coated with copper and nickel, which are firmly joined with the steel by means of a special treatment. This way, all TIG®, TUG® and TUG nature + bullets consist of barrel sparing Carbon steel jackets.

## Barrel Fouling

Whether you shoot with lead-free or lead containing ammunition, the bullet is always pushed through the barrel with a spin. The difference between groove diameter and field

calibre with calibre .30, for instance, is 0.2 millimeter. Depending on the calibre, the bullet is subject to a gas pressure between 3000 and 4400 bar. If and how much remains in the barrel depends on the bullet construction or the bullet's surface. Abrasion has to be removed regularly, otherwise it may have a negative impact on the weapon's precision and may cause a dangerous increase of gas pressure.

We warn against repeated chemical cleaning of barrels, due to the fact that they will be ruined by such treatment. The lead-free BRENNEKE TUG nature + and TAG bullets feature a special coating, requiring just the same amount of barrel cleaning as with lead core bullets.

Fouled barrel

Cleaned barrel

Barrel Fouling

[www.brenneke.com](http://www.brenneke.com)

BRENNEKE AMMUNITION GMBH  
PO Box 16 46  
30837 Langenhagen  
Germany

Phone +49 511 972 62-0  
Fax +49 511 972 62-62  
E-Mail: [info@brenneke.com](mailto:info@brenneke.com)

  
ORIGINAL  
**BRENNEKE**®  
THE ART OF AMMUNITION